

Pioneer

Operating Instructions

ELITE

audio/video multi-channel receiver

SC-37

SC-35

IMPORTANT



The lightning flash with arrowhead symbol, within an equilateral triangle, is intended to alert the user to the presence of uninsulated "dangerous voltage" within the product's enclosure that may be of sufficient magnitude to constitute a risk of electric shock to persons.

CAUTION

**RISK OF ELECTRIC SHOCK
DO NOT OPEN**

CAUTION:
TO PREVENT THE RISK OF ELECTRIC SHOCK, DO NOT REMOVE COVER (OR BACK). NO USER-SERVICEABLE PARTS INSIDE. REFER SERVICING TO QUALIFIED SERVICE PERSONNEL.



The exclamation point within an equilateral triangle is intended to alert the user to the presence of important operating and maintenance (servicing) instructions in the literature accompanying the appliance.

D3-4-2-1-1_A1_En

IMPORTANT SAFETY INSTRUCTIONS

- 1) Read these instructions.
- 2) Keep these instructions.
- 3) Heed all warnings.
- 4) Follow all instructions.
- 5) Do not use this apparatus near water.
- 6) Clean only with dry cloth.
- 7) Do not block any ventilation openings. Install in accordance with the manufacturer's instructions.
- 8) Do not install near any heat sources such as radiators, heat registers, stoves, or other apparatus (including amplifiers) that produce heat.
- 9) Do not defeat the safety purpose of the polarized or grounding-type plug. A polarized plug has two blades with one wider than the other. A grounding type plug has two blades and a third grounding prong. The wide blade or the third prong are provided for your safety. If the provided plug does not fit into your outlet, consult an electrician for replacement of the obsolete outlet.
- 10) Protect the power cord from being walked on or pinched particularly at plugs, convenience receptacles, and the point where they exit from the apparatus.
- 11) Only use attachments/accessories specified by the manufacturer.
- 12) Use only with the cart, stand, tripod, bracket, or table specified by the manufacturer, or sold with the apparatus. When a cart is used, use caution when moving the cart/apparatus combination to avoid injury from tip-over.
- 13) Unplug this apparatus during lightning storms or when unused for long periods of time.
- 14) Refer all servicing to qualified service personnel. Servicing is required when the apparatus has been damaged in any way, such as power-supply cord or plug is damaged, liquid has been spilled or objects have fallen into the apparatus, the apparatus has been exposed to rain or moisture, does not operate normally, or has been dropped.



D3-7-13-69_En

WARNING

This equipment is not waterproof. To prevent a fire or shock hazard, do not place any container filled with liquid near this equipment (such as a vase or flower pot) or expose it to dripping, splashing, rain or moisture.

D3-4-2-1-3_A1_En

WARNING

Before plugging in for the first time, read the following section carefully.

The voltage of the available power supply differs according to country or region. Be sure that the power supply voltage of the area where this unit will be used meets the required voltage (e.g., 230 V or 120 V) written on the rear panel.

D3-4-2-1-4*_A1_En

WARNING

To prevent a fire hazard, do not place any naked flame sources (such as a lighted candle) on the equipment.

D3-4-2-1-7a_A1_En

Operating Environment

Operating environment temperature and humidity: +5 °C to +35 °C (+41 °F to +95 °F); less than 85 %RH (cooling vents not blocked)

Do not install this unit in a poorly ventilated area, or in locations exposed to high humidity or direct sunlight (or strong artificial light)

D3-4-2-1-7c*_A1_En

Caution

To prevent fire hazard, the Class 2 Wiring Cable should be used for connection with speaker, and should be routed away from hazards to avoid damage to the insulation of the cable.

D3-7-13-67*_A1_En

FEDERAL COMMUNICATIONS COMMISSION DECLARATION OF CONFORMITY

This device complies with part 15 of the FCC Rules. Operation is subject to the following two conditions: (1) This device may not cause harmful interference, and (2) this device must accept any interference received, including interference that may cause undesired operation.

Product Name: AUDIO/VIDEO MULTI-CHANNEL RECEIVER

Model Number: SC-37 / SC-35

Responsible Party Name: PIONEER ELECTRONICS (USA) INC.
SERVICE SUPPORT DIVISION

Address: 1925 E. DOMINGUEZ ST. LONG BEACH, CA 90810-1003, U.S.A.

Phone: 1-800-421-1404

URL: <http://www.pioneerelectronics.com>

D8-10-4*_C1_En

NOTE:

This equipment has been tested and found to comply with the limits for a Class B digital device, pursuant to Part 15 of the FCC Rules. These limits are designed to provide reasonable protection against harmful interference in a residential installation. This equipment generates, uses, and can radiate radio frequency energy and, if not installed and used in accordance with the instructions, may cause harmful interference to radio communications. However, there is no guarantee that interference will not occur in a particular installation. If this equipment does cause harmful interference to radio or television reception, which can be determined by turning the equipment off and on, the user is encouraged to try to correct the interference by one or more of the following measures:

- Reorient or relocate the receiving antenna.
- Increase the separation between the equipment and receiver.
- Connect the equipment into an outlet on a circuit different from that to which the receiver is connected.
- Consult the dealer or an experienced radio/TV technician for help.

D8-10-1-2_A1_En

Information to User

Alterations or modifications carried out without appropriate authorization may invalidate the user's right to operate the equipment.

D8-10-2_A1_En

CAUTION

This product satisfies FCC regulations when shielded cables and connectors are used to connect the unit to other equipment. To prevent electromagnetic interference with electric appliances such as radios and televisions, use shielded cables and connectors for connections.

D8-10-3a_A1_En

IMPORTANT NOTICE

THE MODEL NUMBER AND SERIAL NUMBER OF THIS EQUIPMENT ARE ON THE REAR OR BOTTOM. RECORD THESE NUMBERS ON YOUR ENCLOSED WARRANTY CARD AND KEEP IN A SAFE PLACE FOR FUTURE REFERENCE.

D36-AP9-1_A1_En

If the AC plug of this unit does not match the AC outlet you want to use, the plug must be removed and appropriate one fitted. Replacement and mounting of an AC plug on the power supply cord of this unit should be performed only by qualified service personnel. If connected to an AC outlet, the cut-off plug can cause severe electrical shock. Make sure it is properly disposed of after removal. The equipment should be disconnected by removing the mains plug from the wall socket when left unused for a long period of time (for example, when on vacation).

D3-4-2-2-1a_A1_En

VENTILATION CAUTION

When installing this unit, make sure to leave space around the unit for ventilation to improve heat radiation (at least 20 cm at top, 10 cm at rear, and 20 cm at each side).

WARNING

Slots and openings in the cabinet are provided for ventilation to ensure reliable operation of the product, and to protect it from overheating. To prevent fire hazard, the openings should never be blocked or covered with items (such as newspapers, table-cloths, curtains) or by operating the equipment on thick carpet or a bed.

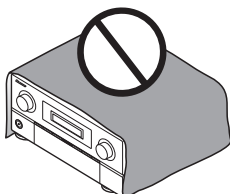

D3-4-2-1-7b*_A1_En

CAUTION

The **STANDBY/ON** switch on this unit will not completely shut off all power from the AC outlet. Since the power cord serves as the main disconnect device for the unit, you will need to unplug it from the AC outlet to shut down all power. Therefore, make sure the unit has been installed so that the power cord can be easily unplugged from the AC outlet in case of an accident. To avoid fire hazard, the power cord should also be unplugged from the AC outlet when left unused for a long period of time (for example, when on vacation).

D3-4-2-2-2a*_A1_En

This product is for general household purposes. Any failure due to use for other than household purposes (such as long-term use for business purposes in a restaurant or use in a car or ship) and which requires repair will be charged for even during the warranty period.

K041_A1_En

WARNING: Handling the cord on this product or cords associated with accessories sold with the product may expose you to chemicals listed on proposition 65 known to the State of California and other governmental entities to cause cancer and birth defect or other reproductive harm.

Wash hands after handling.

D36-P5_B1_En

SC-37 only

This device complies with Part 15 of the FCC Rules. Operation is subject to the following two conditions: (1) this device may not cause interference, and (2) this device must accept any interference, including interference that may cause undesired operation of the device.

Caution

FCC Radiation Exposure Statement: This equipment complies with FCC radiation exposure limits set forth for an uncontrolled environment. This equipment should be installed and operated with minimum distance 20 cm between the radiator and your body.

Thank you for buying this Pioneer product. Please read through these operating instructions so you will know how to operate your model properly. After you have finished reading the instructions, put them away in a safe place for future reference.

Contents

01 Before you start

Our philosophy	9
Features.....	9
Checking what's in the box	10
Installing the receiver	10
Loading the batteries	10
Operating range of remote control unit	11
Flow for operating the receiver with RF two-way communications (<i>SC-37 only</i>)	11

02 Controls and displays

Remote control (In case of SC-37)	12
Remote control display	13
RF adapter.....	14
Remote control (In case of SC-35)	15
Display.....	16
Front panel	18

03 Connecting your equipment

Rear panel.....	20
Connecting the RF adapter (<i>SC-37 only</i>).....	21
Determining the speakers' application	22
Other speaker connections	23
Placing the speakers	23
THX speaker system setup	23
Some tips for improving sound quality	23
Connecting the speakers.....	24
Installing your speaker system.....	25
Standard surround connection	25
Bi-amping your speakers.....	26
Bi-wiring your speakers.....	26
Selecting the Speaker system	27
Front height setup.....	27
Front wide setup	27
Speaker B setup	27
Bi-Amping setup	27
ZONE 2 setup	27
About the audio connection.....	27
About the video converter	27
About HDMI	28
Connecting your TV and playback components	29
Connecting using HDMI	29
Connecting your DVD player with no HDMI output	30
Connecting your TV with no HDMI input	31
Connecting an HDD/DVD recorder, BD recorder and other video sources.....	32
Connecting a satellite/cable receiver or other set-top box.....	33
Connecting the multichannel analog inputs	34
Connecting other audio components.....	35
About the WMA9 Pro decoder.....	35
Connecting additional amplifiers.....	36

Connecting AM/FM antennas	36
Connecting external antennas	37
MULTI-ZONE setup	37
Making MULTI-ZONE connections	37
Connecting to the network through LAN interface... ..	38
Connecting Optional Bluetooth® ADAPTER	39
Connecting an HDMI-equipped component to the front panel input	39
Connecting an XM Radio tuner	39
Connecting a SiriusConnect™ tuner	39
Connecting an iPod.....	40
Connecting a USB device	40
Connecting a USB device for Advanced MCACC output	40
Connecting an IR receiver	41
Operating other Pioneer components with this unit's sensor	41
Switching components on and off using the 12 volt trigger	42
Plugging in the receiver.....	42

04 Basic Setup

Changing the OSD display language (OSD Language)	43
Automatically conducting optimum sound tuning (Full Auto MCACC)	43
Problems when using the Auto MCACC Setup	45
The Input Setup menu	45
Input function default and possible settings	46

05 Basic playback

Playing a source	47
Playing a source with HDMI connection	47
Selecting the multichannel analog inputs.....	47
Playing an iPod	48
Playing back audio files stored on an iPod	48
Playing a USB device.....	49
Playing back audio files stored on a USB memory device	49
Playing back photo files stored on a USB memory device	50
About playable file formats	51
Listening to the radio.....	52
Improving FM sound	52
Using the noise cut mode	52
Using Neural Surround.....	52
Tuning directly to a station	52
Saving station presets.....	52
Listening to station presets.....	52
Naming station presets.....	53
Listening to Satellite Radio	53

Listening to XM Radio	53
Using XM HD Surround	54
Saving channel presets	54
Using the XM Menu	54
Listening to SIRIUS Radio	54
Saving channel presets	55
Using the SIRIUS Menu	55
Listening to Internet radio stations (SC-35 only)	56
Programming the Internet radio stations	56
<i>Bluetooth</i> ADAPTER for Wireless Enjoyment of Music	57
Wireless music play	57
Pairing the Bluetooth ADAPTER and Bluetooth wireless technology device	58
Listening to music contents of a Bluetooth wireless technology device with your system	58
06 Listening to your system	
Auto playback	59
Listening in surround sound	59
Standard surround sound	59
Using the Home THX modes	60
Using the Advanced surround effects	61
Listening in stereo	61
Using Front Stage Surround Advance	61
Using Stream Direct	62
Selecting MCACC presets	62
Choosing the input signal	62
Better sound using Phase Control	62
Better sound using Phase Control and Full Band Phase Control (SC-37 only)	63
07 Playback with HOME MEDIA GALLERY inputs (SC-37 only)	
Enjoying the Home Media Gallery	64
Features of Home Media Gallery	64
Introduction	64
Authorizing this receiver	64
Playback with Home Media Gallery	65
Playing back audio files stored on components on the network	65
Listening to Internet radio stations	66
Listening to Rhapsody	66
Listening to Sirius Internet Radio	67
Listening to Neural Music Direct	67
Playing back your favorite songs	67
Advanced operations for Internet radio	67
Saving Internet radio stations	67
Retrieving saved Internet radio stations	67
Checking about the Accounts	68
About network playback	68
Windows Media Player	68
Windows Media DRM	68
DLNA	68
Content playable over a network	68
About playback behavior over a network	69
Software update	69
About playable file formats	70
Glossary	71

08 Control with HDMI function

Making Control with HDMI connections	72
HDMI Setup	73
Before using synchronization	73
About synchronized operations	74
About connections with a product of a different brand that supports the Control with HDMI function	74
Setting the PQLS function	75
Cautions on the Control with HDMI function	75

09 Using other functions

Setting the Audio options	76
Setting the Video options	78
Switching the speaker terminals	79
Using the MULTI-ZONE controls	79
Making an audio or a video recording	80
Reducing the level of an analog signal	80
Using the sleep timer	81
Dimming the display	81
Switching the HDMI output	81
Using the Web Control function	81
Checking your system settings	81
Resetting the system	82
Default system settings	82

10 Controlling the rest of your system (In case of SC-37)

About the Remote Setup menu	83
Operating multiple receivers	84
Setting the remote to control other components	84
Selecting preset codes directly	84
Programming signals from other remote controls	85
Erasing one of the remote control button settings	85
Resetting the input assignment of one of the input function buttons	86
Resetting the remote control settings	86
Confirming preset codes	86
Renaming input function names manually	86
Direct function	86
Multi Operation and System Off	87
Programming a multi-operation or a shutdown sequence	87
Using multi operations	88
Using System off	88
Controlling components	88
Using the RF communications function	91
Pairing the RF adapter and remote control	92
Operating this receiver by RF communications	92
Operating other components by RF communications	92
Renaming input function names in synchrony with the receiver	93
Setting the remote control operation mode	94
Precautions when using the Omni-Directional RF Remote Control	94
Precautions regarding wavelength	94
Usable range	95
Signal reflection	95
For safe use	95

10 Controlling the rest of your system (In case of SC-35)

About the Remote Setup menu	96
Operating multiple receivers	96
Setting the remote to control other components	97
Selecting preset codes directly	97
Programming signals from other remote controls	97
Erasing one of the remote control button settings	98
Erasing all learnt settings that are in one input function	98
Direct function	98
Setting the backlight mode	99
Multi operation and System off	99
Programming a Multi operation or a shutdown sequence	100
Using multi operations	100
Using System off	100
Erasing the settings for the multi-operation	100
Resetting the remote control settings	101
Default preset codes	101
Controlling components	101

11 The Advanced MCACC menu

Making receiver settings from the Advanced MCACC menu	104
Automatic MCACC (Expert)	104
Manual MCACC setup	106
Fine Channel Level	107
Fine Speaker Distance	107
Standing Wave	107
Acoustic Calibration EQ Adjust	108
Acoustic Calibration EQ Professional	108
Precision Distance (<i>SC-37 only</i>)	110
Checking MCACC Data	110
Speaker Setting	111
Channel Level	111
Speaker Distance	111
Standing Wave	111
Acoustic Cal EQ	111
Group Delay (<i>SC-37 only</i>)	111
Output MCACC data	112
Data Management	112
Renaming MCACC presets	112
Copying MCACC preset data	113
Clearing MCACC presets	113

12 The System Setup and Other Setup menus

Making receiver settings from the System Setup menu	114
Manual speaker setup	114
Speaker system setting	115
Speaker Setting	115
Channel Level	116
Speaker Distance	116
X-Curve	117
THX Audio Setting	117
Network Setup menu	117
IP address/Proxy setting	118
Checking the MAC address	118
Network Standby	118
The Other Setup menu	119
Volume Setup	119
Remote Control Mode Setup	119
Flicker Reduction Setup	120
RF Remote Setup (<i>SC-37 only</i>)	120
EXTENSION Setup (<i>SC-35 only</i>)	120
Multi Channel Input Setup	120

13 Additional information

Speaker Setting Guide	121
Positional relationship between speakers and monitor	122
Troubleshooting	122
Power	122
No sound	123
Other audio problems	124
ADAPTER PORT	125
Video	125
Settings	126
Professional Calibration EQ graphical output	127
Display	127
Remote control	128
Web Control	128
HDMI	129
Important information regarding the HDMI connection	130
USB interface	130
Internet radio (<i>SC-35 only</i>)	131
XM radio messages	131
SIRIUS radio messages	132
HOME MEDIA GALLERY (<i>SC-37 only</i>)	133
Surround sound formats	135
Dolby	135
DTS	135
Windows Media Audio 9 Professional	135
About THX	135
About iPod	137
About SIRIUS and XM	137
About FLAC	137
FLAC Decoder	137
Auto Surround, ALC and Stream Direct with different input signal formats	138
Preset code list (<i>SC-35 only</i>)	139
Specifications	143
Cleaning the unit	144

Flow of settings on the receiver

The unit is a full-fledged AV receiver equipped with an abundance of functions and terminals. It can be used easily after following the procedure below to make the connections and settings.

The colors of the steps indicate the following:

Required setting item

Setting to be made as necessary

1 Before you start

- Checking what's in the box (page 10)
- Loading the batteries (page 10)



2 Determining the speakers' application (page 22)

- 9.1 channel surround system (Front height)
- 9.1 channel surround system (Front wide)
- 7.1 channel surround system & Speaker B connection
- 5.1 channel surround system & Front Bi-amping connection (High quality surround)
- 5.1 channel surround system & ZONE 2 connection (Multi Zone)



3 Connecting the speakers

- Placing the speakers (page 23)
- Connecting the speakers (page 24)
- Installing your speaker system (page 25)
- Bi-amping your speakers (page 26)



4 Connecting the components

- About the audio connection (page 27)
- About the video converter (page 27)
- Connecting your TV and playback components (page 29)
- Connecting AM/FM antennas (page 36)
- Plugging in the receiver (page 42)



5 Power On



6 Changing the OSD display language (OSD Language) (page 43)



7 MCACC speaker settings

- Automatically conducting optimum sound tuning (Full Auto MCACC) (page 43)



8 The Input Setup menu (page 45)

(When using connections other than the recommended connections)



9 Basic playback (page 47)



10 Switching the HDMI output (page 81)



11 Adjusting the sound and picture quality as desired

- Using the various listening modes
- Better sound using Phase Control (page 62)
- Better sound using Phase Control and Full Band Phase Control (SC-37 only) (page 63)
- Measuring the all EQ type (SYMMETRY/ALL CH ADJ/FRONT ALIGN) (page 104)
- Changing the channel level while listening (*Tip* on page 116)
- Switching on/off the Acoustic Calibration EQ, Sound retriever or Dialog Enhancement (page 76)
- Setting the PQLS function (page 75)
- Setting the Audio options (Tone, Loudness or Sound delay, etc.) (page 76)
- Setting the Video options (page 78)



12 Other optional adjustments and settings

- Control with HDMI function (page 72)
- The Advanced MCACC menu (page 104)
- The System Setup and Other Setup menus (page 114)



13 Making maximum use of the remote control

SC-37:

- Operating multiple receivers (page 84)
- Setting the remote to control other components (page 84)
- Using the RF communications function (page 91)

SC-35:

- Operating multiple receivers (page 96)
- Setting the remote to control other components (page 97)

Chapter 1: Before you start

Our philosophy

Pioneer is dedicated to making your home theater listening experience as close as possible to the vision of the moviemakers and mastering engineer when they created the original soundtrack. We do this by focusing on three important steps:

- 1 **Achieving the highest possible sound quality**
- 2 **Allowing for customized acoustic calibration according to any listening area**
- 3 **Fine-tuning the receiver with the help of world-class studio engineers***

* With the cooperation of AIR Studios, this receiver has been designated AIR Studios Monitor.



Features

- **Direct Energy HD Amplifier**

Through a collaboration, Pioneer and ICEpower have jointly developed a unique class D amplifier called a "Direct Energy HD (High Fidelity Class D) amplifier". This new generation reference amplifier offers outstanding performance with high sound quality and reproduces the latest in multi-channel digital contents.

- **HDMI (Ver.1.4 with 3D, Audio Return Channel)**

A compatible component is required to use the above function.

- **Remote operation on an iPhone/iPod touch**

Operation via LAN is possible from an iPhone or iPod touch by downloading a Pioneer original application (iControlAV) from the iTunes Store.

- **iPhone/iPod playback**

Your iPhone or iPod can be connected to the receiver's USB terminal to play the music/video files on the iPhone/iPod.

- **PQLS¹**

Jitterless high quality playback is possible by connecting a PQLS-compatible player with HDMI connections.

- **Dolby Pro Logic IIz compatible**

Adding a pair of speakers above the front left and right speakers adds expressiveness in the vertical direction to the previous horizontally-oriented sound field. The height channel strengthens the sound field's sense of three-dimensionality and air, producing presence and expansion.

- **Internet Radio**

By connecting this receiver to the network via the LAN terminal, you can listen to Internet radio stations.

- **HOME MEDIA GALLERY²**

This receiver can play back contents stored on your computer when your computer is connected to the LAN terminal of this receiver.

- **XM and SIRIUS Ready**

With the XM and SIRIUS Radio terminals, you'll be up and running in no time.

- **Bluetooth compatible**

Using the *Bluetooth* ADAPTER (Pioneer Model No. AS-BT100)³ lets you enjoy music files on an iPhone or other *Bluetooth* wireless technology device wirelessly.

- **Sound Retriever and Sound Retriever Air**

The Sound Retriever feature employs DSP technology to restore sound pressure and smooth jagged artifacts left over after compression. Sound Retriever Air compensates for reduced sound quality due to compression when sending *Bluetooth* signals.

- **Easy setup using Advanced MCACC**

The Auto MCACC Setup provides a quick but accurate surround sound setup, which includes the advanced features of Professional Acoustic Calibration EQ.

- **Web control**

The receiver can be operated using a browser from a computer connected on the same LAN as the receiver.

- **RF two-way communications function**

Using the CU-RF100⁴, the information shown of the receiver's display can be displayed on the remote control in your hands and you can operate the remote control without worrying about obstacles or the direction in which the remote control is pointing.

Note

¹ The PQLS functions supported for the different models are as shown below.

SC-37: PQLS Bit-stream/PQLS Multi Surround/PQLS 2ch Audio. SC-35: PQLS Multi Surround/PQLS 2ch Audio.

² Home Media Gallery is only supported on the SC-37.

³ The AS-BT100 is sold separately.

⁴ The CU-RF100 is included with the SC-37, sold separately with the SC-35.

Checking what's in the box

Please check that you've received the following supplied accessories:

In case of SC-37

- Setup microphone (cable: 5 m (16.4 ft.))
- Omni-directional remote control (CU-RF100)
- RF adapter
- IR blaster cable x2
- AA/LR6 dry cell batteries x4
- AM loop antenna
- FM wire antenna
- iPod cable
- Power cord
- Warranty card
- These operating instructions

In case of SC-35

- Setup microphone (cable: 5 m (16.4 ft.))
- Remote control unit
- AAA size IEC R03 dry cell batteries (to confirm system operation) x2
- AM loop antenna
- FM wire antenna
- iPod cable
- Power cord
- Warranty card
- These operating instructions

Installing the receiver

- When installing this unit, make sure to put it on a level and stable surface.

Don't install it on the following places:

- on a color TV (the screen may distort)
- near a cassette deck (or close to a device that gives off a magnetic field). This may interfere with the sound.
- in direct sunlight
- in damp or wet areas
- in extremely hot or cold areas
- in places where there is vibration or other movement
- in places that are very dusty
- in places that have hot fumes or oils (such as a kitchen)

- Do not touch this receiver's bottom panel while the power is on or just after it is turned off. The bottom panel becomes hot when the power is on (or right after it is turned off) and could cause burns.

Loading the batteries

In case of SC-37

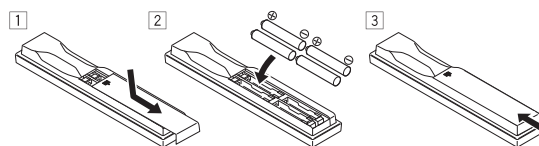

In case of SC-35

The batteries included with the unit are to check initial operations; they may not last over a long period. We recommend using alkaline batteries that have a longer life.

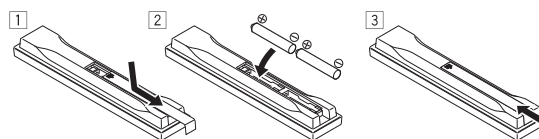

⚠ CAUTION

Incorrect use of batteries may result in such hazards as leakage and bursting. Observe the following precautions:

- Never use new and old batteries together.
- Insert the plus and minus sides of the batteries properly according to the marks in the battery case.
- Batteries with the same shape may have different voltages. Do not use different batteries together.
- When disposing of used batteries, please comply with governmental regulations or environmental public instruction's rules that apply in your country or area.
- **WARNING**

Do not use or store batteries in direct sunlight or other excessively hot place, such as inside a car or near a heater. This can cause batteries to leak, overheat, explode or catch fire. It can also reduce the life or performance of batteries.

Operating range of remote control unit

The remote control may not work properly if:

- There are obstacles between the remote control and the receiver's remote sensor.
- Direct sunlight or fluorescent light is shining onto the remote sensor.
- The receiver is located near a device that is emitting infrared rays.
- The receiver is operated simultaneously with another infrared remote control unit.

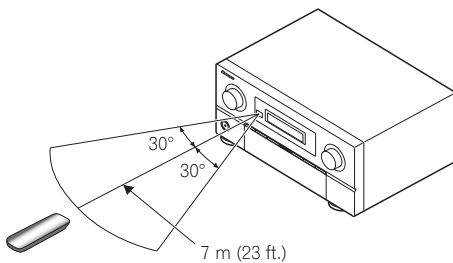

Tip

- By connecting an RF adapter to the RS-232C and CU-RF100 terminals (SC-37) / EXTENSION terminals (SC-35), the CU-RF100 omni-directional remote control can be used for RF two-way communications with the receiver.¹ With RF two-way communications, the information of the receiver's display can be displayed on the remote control in your hands and the remote control can be operated without worrying about obstacles or the direction in which the remote control is pointing.² For details, see *Flow for operating the receiver with RF two-way communications (SC-37 only)* below.

Flow for operating the receiver with RF two-way communications

(SC-37 only)

This remote control unit is set for operations using infrared signals upon shipment from the factory. To set it for RF operations, take the steps below.

1 Connecting the RF adapter to the RS-232C and CU-RF100 terminals.

- *Connecting the RF adapter (SC-37 only)* on page 21



2 Setting the 'RF Remote Setup' to 'ON'.

- *RF Remote Setup (SC-37 only)* on page 120



3 Pairing the RF adapter and remote control.

- *Pairing the RF adapter and remote control* on page 92



4 Setting 'RECEIVER MAIN' to 'RF MODE' for the remote control unit's 'IR/RF SELECT' setting.

- *Operating this receiver by RF communications* on page 92

Note

¹ The RF adapter and CU-RF100 omni-directional remote control are included with the SC-37, sold separately with the SC-35.

² The maximum line-of-sight distance for RF two-way communications is about 10 meters. This line-of-sight communications distance is a rough indication, and may differ according to the surrounding environment.

Chapter 2:

Controls and displays

Remote control (In case of SC-37)

This section explains how to operate the remote control for the receiver.

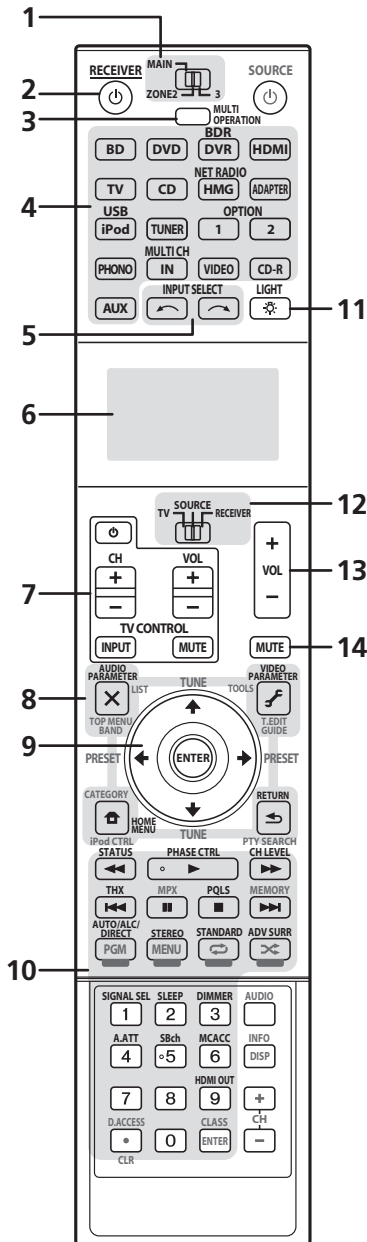

The remote has been conveniently color-coded according to component control using the following system:

- **White** – Receiver control, TV control
- **Blue** – Other controls (See page 48, 49, 52, 57 and 88.)

1 MULTI-ZONE operation selector switch

Switch to perform operations in the main zone, ZONE 2 and ZONE 3 (page 80).

2 RECEIVER

This switches between standby and on for this receiver.

3 MULTI OPERATION

Use this button to perform multi operations (page 99).

4 Input function buttons

Press to select control of other components (page 83). With these models, the Sirius input is selected with the **OPTION 1** button, the XM input with the **OPTION 2** button. Also, there is no **AUX** input on this receiver, so the **AUX** button cannot be used.

5 INPUT SELECT

Use to select the input function (page 47).

6 Character display

This display shows information when transmitting control signals. The remote screen's display differs when operating the receiver by sending infrared signals from the remote control and when operating it by RF two-way communications. For details, see *Remote control display* on page 13.

7 TV CONTROL buttons

These buttons are dedicated to control the TV assigned to the **TV** operation selector switch.

8 Receiver setting buttons

Set the remote control operation selector switch to **RECEIVER** first to access:

AUDIO PARAMETER – Use to access the Audio options (page 76).

VIDEO PARAMETER – Use to access the Video options (page 78).

HOME MENU – Use to access the Home Menu (pages 43, 45, 73, 104, 114 and 117).

RETURN – Press to confirm and exit the current menu screen.

9 ↑/↓/←/→/ENTER

Use the arrow buttons when setting up your surround sound system (see page 104) and the Audio or Video options (page 76 or 78).

10 Receiver Control buttons

Set the remote control operation selector switch to **RECEIVER** first to access:

STATUS – Press to check selected receiver settings (page 81).

PHASE CTRL – Press to switch on/off Phase Control or Full Band Phase Control (page 63).

CH LEVEL – Press repeatedly to select a channel, then use **←/→** to adjust the level (page 116).

THX – Press to select a Home THX listening mode (page 60).

PQLS – Press to select the PQLS setting (page 75).

AUTO/ALC/DIRECT – Switches between Auto Surround (page 59), Auto Level Control, Optimum Surround mode and Stream Direct mode (page 62).

STEREO – Switches between stereo playback and Front Stage Surround Advance modes (page 61).

STANDARD – Press for Standard decoding and to switch various modes (**DD** Pro Logic, Neo:6, etc.) (page 59).

ADV SURR – Use to switch between the various surround modes (page 61).

SIGNAL SEL – Use to select an input signal (page 62).

SLEEP – Use to put the receiver in sleep mode and select the amount of time before sleep (page 81).

DIMMER – Dims or brightens the display (page 81).

A.ATT – Attenuates (lowers) the level of an analog input signal to prevent distortion (page 80).

SBch – With this receiver, **SBch** cannot be used.

MCACC – Press to switch between MCACC presets (page 62).

HDMI OUT – Switch the HDMI output terminal (page 81).

11 LIGHT

Press to turn on/off the illumination for the buttons.¹

12 Remote control operation selector switch

Set to **RECEIVER** to operate the receiver, **TV** or **SOURCE** to operate the TV or the source device.

When this switch is set to **RECEIVER**, the receiver can be controlled (used to select the white commands). Also use this switch to set up surround sound.

13 VOL +/-

Use to set the listening volume.

14 MUTE

Mutes the sound or restores the sound if it has been muted (adjusting the volume also restores the sound).

Remote control display²

Remote control display for infrared signal transmission (default)

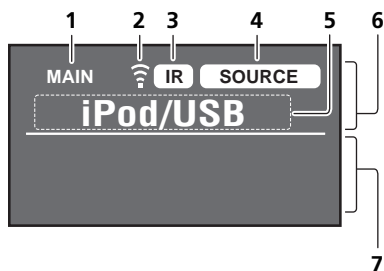

Remote control display for RF two-way communications³

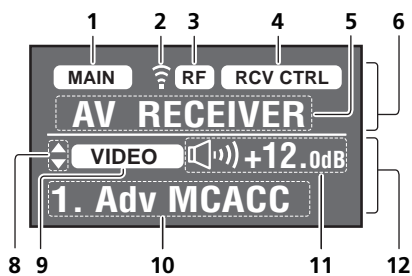

1 Remote control operating zone indicator

This indicates which zone the remote control is currently set to operate. The display indicates the setting of the MULTI-ZONE operation selector switch.

Only when RF two-way communications:

The box display here indicates the communication status between this remote control unit and the receiver.

MAIN (White box with black letters): Two-way communications are established and the receiver's power is on.

Note

- 1 Press and hold in the **LIGHT** button for 5 seconds to change the illumination mode 1 or 2. When set to **LIGHT MODE 2** (default), the illumination only lights when the remote control **LIGHT** button is pressed. When switched to **LIGHT MODE 1**, the illumination lights whenever buttons are operated. Setting **LIGHT MODE 1** will shorten the service life of the batteries.
- 2 The display lights when a remote control operation is performed, then turns off after 20 seconds if no other operation is performed. When in the Remote Setup mode, the setup is canceled and the display turns off if no operation is performed for 1 minute (page 83).
- 3 • This is displayed when an RF adapter is connected to the receiver and paired with the remote control. For details, see *Using the RF communications function* on page 91.
 - Depending on the communications environment, two-way communications may not work well and the remote control display may not reflect the receiver's status.

MAIN (Gray box with black letters): Two-way communications are established and the receiver's power is off.

MAIN (White letters only): Two-way communications are not working well. In this case, the area indicating the receiver's status (**12**) is not displayed.

2 Remote control code sending indicator

This appears when signals are sent from the remote control.

3 Remote control code sending mode indicator

This indicates whether remote control codes are being sent by infrared (IR) signal or RF communications.

4 Remote control operation indicator

This indicates which operation mode the remote control is currently set to. The display indicates the setting of the remote control operation selector switch.

5 Input function and sending code indicator

This indicates what input function can currently be operated with the remote control. Also, when a button is pressed and its operation code is sent, the name of that code is displayed.

6 Area indicating the remote control's status

7 Nothing displayed

Nothing is displayed here when the remote control code sending mode is set to IR.

8 Scroll indicators

Light when there are more selectable items when making the various settings.

9 Receiver input indicator

This indicates the input function currently selected for the receiver's zone.

10 Receiver display

The same information as on the receiver's display is displayed here.

11 Master volume display

This indicates the volume of the receiver's main zone using, as an icon and in decibels (dB). When the sound is muted, the  icon is displayed.

12 Area indicating the receiver's status

RF adapter

Front

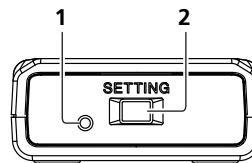

Rear

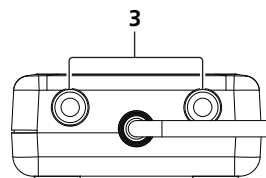

1 LED

2 SETTING

Use to pairing the RF adapter and remote control (page 91).

3 IR blaster terminals

Connect the IR blaster cable (page 92).

Remote control (In case of SC-35)

This section explains how to operate the remote control for the receiver.

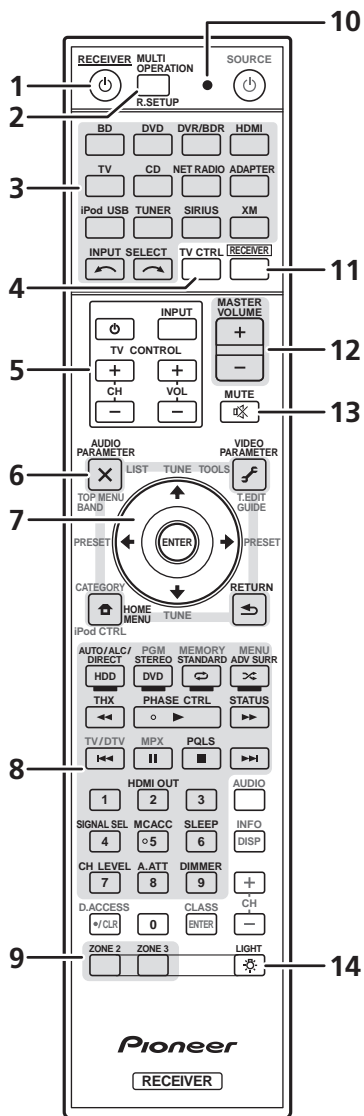

The remote has been conveniently color-coded according to component control using the following system:

- **White** – Receiver control, TV control
- **Blue** – Other controls (See page 48, 49, 52, 53, 57 and 101.)

1 **RECEIVER**

This switches between standby and on for this receiver.

2 **MULTI OPERATION**

Use to perform multi operations (page 99).

R.SETUP – Use to input the preset code when making remote control settings and to set the remote control mode (page 83).

3 **Input function buttons**

Press to select control of other components (page 83).

Use **INPUT SELECT** to select the input function (page 47).

4 **TV CTRL**

Set the preset code of your TV's manufacturer when controlling the TV (page 97).

5 **TV CONTROL buttons**

These buttons are dedicated to control the TV assigned to the **TV CTRL** button.

6 **Receiver setting buttons**

Press **RECEIVER** first to access:

AUDIO PARAMETER – Use to access the Audio options (page 76).

VIDEO PARAMETER – Use to access the Video options (page 78).

HOME MENU – Use to access the Home Menu (pages 43, 45, 73, 104, 114 and 117).

RETURN – Press to confirm and exit the current menu screen.

7 **↑/↓/←/→/ENTER**

Use the arrow buttons when setting up your surround sound system (see page 104) and the Audio or Video options (page 76 or 78).

8 **Receiver Control buttons**

Press **RECEIVER** first to access:

AUTO/ALC/DIRECT – Switches between Auto Surround (page 59), Auto Level Control mode and Stream Direct mode (page 62).

STEREO – Switches between stereo playback and Front Stage Surround Advance modes (page 61).

STANDARD – Press for Standard decoding and to switch various modes (**PRO** Pro Logic, Neo:6, etc.) (page 59).

ADV SURR – Use to switch between the various surround modes (page 61).

THX – Press to select a Home THX listening mode (page 60).

PHASE CTRL – Press to switch on/off Phase Control (page 62).

STATUS – Press to check selected receiver settings (page 81).

PQLS – Press to select the PQLS setting (page 75).

HDMI OUT – Switch the HDMI output terminal (page 81).

SIGNAL SEL – Use to select an input signal (page 62).

MCACC – Press to switch between MCACC presets (page 62).

SLEEP – Use to put the receiver in sleep mode and select the amount of time before sleep (page 81).

CH LEVEL – Press repeatedly to select a channel, then use \leftarrow/\rightarrow to adjust the level (page 116).

A.ATT – Attenuates (lowers) the level of an analog input signal to prevent distortion (page 80).

DIMMER – Dims or brightens the display (page 81).

9 MULTI-ZONE select buttons

Switch to perform operations in ZONE 2 and ZONE 3 (page 80).

10 Remote control LED

Lights when a command is sent from the remote control.

11 RECEIVER

Switches the remote to control the receiver (used to select the white commands).

Switch to perform operations in the main zone.

Also use this button to set up surround sound.

12 MASTER VOLUME +/-

Use to set the listening volume.

13 MUTE

Mutes the sound or restores the sound if it has been muted (adjusting the volume also restores the sound).

14

Press to turn on/off the illumination for the buttons. The way the buttons light can be selected from four modes (page 99).

Display

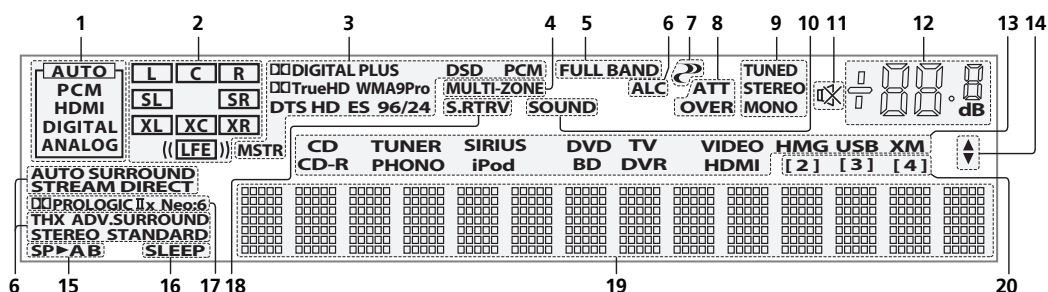

1 SIGNAL indicators

Light to indicate the currently selected input signal.

AUTO lights when the receiver is set to select the input signal automatically (page 62).

2 Program format indicators

Light to indicate the channels to which digital signals are being input.

L/R – Left front/Right front channel

C – Center channel

SL/SR – Left surround/Right surround channel

LFE – Low frequency effects channel (the (()) indicators light when an LFE signal is being input)

XL/XR – Two channels other than the ones above

XC – Either one channel other than the ones above, the mono surround channel or matrix encode flag

3 Digital format indicators

Light when a signal encoded in the corresponding format is detected.

 **DIGITAL** – Lights with Dolby Digital decoding.

 **DIGITAL PLUS** – Lights with Dolby Digital Plus decoding.

 **TrueHD** – Lights with Dolby TrueHD decoding.

DTS – Lights with DTS decoding.

DTS HD – Lights with DTS-HD decoding.

96/24 – Lights with DTS 96/24 decoding.

WMA9 Pro – Lights to indicate that a WMA9 Pro signal is being decoded.

DSD PCM – Light during DSD (Direct Stream Digital) to PCM conversion with SACDs.

PCM – Lights during playback of PCM signals.

MSTR – Lights during playback of DTS-HD Master Audio signals.

4 MULTI-ZONE

Lights when the MULTI-ZONE feature is active (page 79).

5 FULL BAND

SC-37 only: Lights when the Full Band Phase Control is switched on (page 63).

6 Listening mode indicators

AUTO SURROUND – Lights when the Auto Surround feature is switched on (page 59).

ALC – Lights when the ALC (Auto level control) mode is selected (page 62).

STREAM DIRECT – Lights when Direct/Pure Direct is selected (page 62).

ADV.SURROUND – Lights when one of the Advanced Surround modes has been selected (page 61).

STEREO – Lights when stereo listening is switched on (page 61).

STANDARD – Lights when one of the Standard Surround modes is switched on (page 59).

THX – Lights when one of the Home THX modes is selected (page 60).

7 (PHASE CONTROL)

Lights when the Phase Control or Full Band Phase Control¹ is switched on (page 62 and 63).

8 Analog signal indicators

Light to indicate reducing the level of an analog signal (page 80).

9 Tuner indicators

TUNED – Lights when a broadcast is being received.

STEREO – Lights when a stereo FM broadcast is being received in auto stereo mode.

MONO – Lights when the mono mode is set using MPX.

10 SOUND

Lights when any of the Midnight, Loudness or tone controls features is selected (page 76).

Lights when Dialog Enhancement is switched on.

11

Lights when the sound is muted (page 16).

12 Master volume level

Shows the overall volume level.

“---” indicates the minimum level, and “+12dB” indicates the maximum level.

13 Input function indicators

Light to indicate the input function you have selected. (HMG only lights for the SC-37.)

14 Scroll indicators

Light when there are more selectable items when making the various settings.



15 Speaker indicators

Lights to indicate the current speaker system, **A** and/or **B** (page 79).

16 SLEEP

Lights when the receiver is in sleep mode (page 81).

17 Matrix decoding format indicators

 **PRO LOGIC IIx** – This lights to indicate  Pro Logic II /  Pro Logic IIx decoding (page 59).

Neo:6 – When one of the Neo:6 modes of the receiver is on, this lights to indicate Neo:6 processing (page 59).

18 S.RTRV

Lights when the Sound Retriever function is active (page 76).

19 Character display

Displays various system information.

20 Remote control mode indicator

Lights to indicate the receiver's remote control mode setting. (Not displayed when set to **1.**) (SC-37: page 84, SC-35: page 96)

Note

¹ Full Band Phase Control is only apply to the SC-37.

Front panel

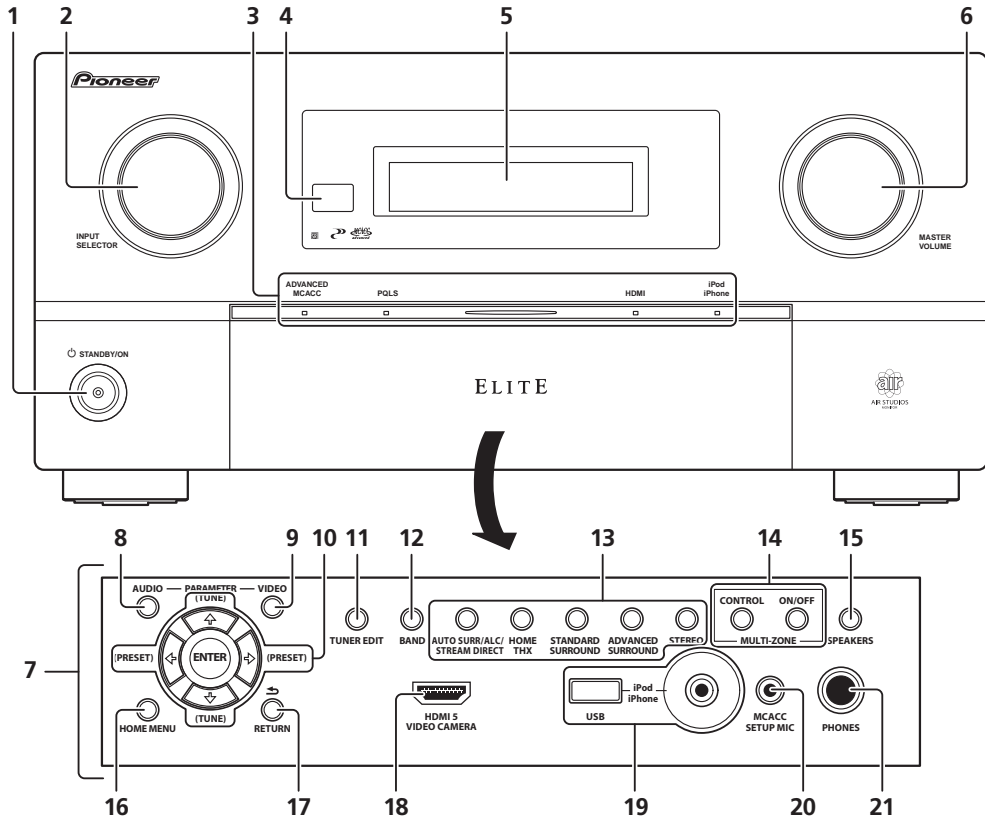

1 STANDBY/ON

Switches the receiver between on and standby.

2 INPUT SELECTOR dial

Use to select an input function.

3 Indicators

ADVANCED MCACC – Lights when **EQ** is set to **ON** in the **AUDIO PARAMETER** menu (page 76).

PQLS – Lights when the PQLS feature is active (page 75).

HDMI – Blinks when connecting an HDMI-equipped component; lights when the component is connected (page 29).

iPod/iPhone – Lights to indicate iPod/iPhone is connected (page 40).

4 Remote sensor

Receives the signals from the remote control (see *Operating range of remote control unit* on page 11).

5 Character display

See *Display* on page 16.

6 MASTER VOLUME dial

7 Front panel controls

To access the front panel controls, push gently on the lower third portion of the panel with your finger.

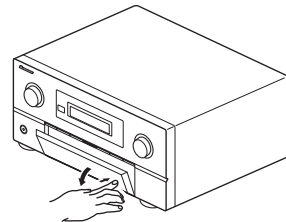

8 AUDIO PARAMETER

Use to access the Audio options (page 76).

9 VIDEO PARAMETER

Use to access the Video options (page 78).

10 (TUNE/PRESET)/ENTER

Use the arrow buttons when setting up your **Home Menu**. Use **TUNE** to find radio frequencies and use **PRESET** to find preset stations (page 52).

11 TUNER EDIT

Use with **↑/↓/←/→/ENTER** to memorize and name stations for recall (page 52).

12 BAND

Switches between AM and FM radio bands (page 52).

13 Listening mode buttons

AUTO SURR/ALC/STREAM DIRECT – Switches between Auto Surround (page 59), Auto Level Control, Optimum Surround¹ mode and Stream Direct mode (page 62).

HOME THX – Press to select a Home THX listening mode (page 60).

STANDARD SURROUND – Press for Standard decoding and to switch various modes (Dolby Pro Logic, Neo:6, etc.) (page 59).

ADVANCED SURROUND – Use to switch between the various surround modes (page 61).

STEREO – Switches between stereo playback and Front Stage Surround Advance modes (page 61).

14 MULTI-ZONE controls

If you've made MULTI-ZONE connections (see *MULTI-ZONE setup* on page 37) use these controls to control the sub zone from the main zone (see *Using the MULTI-ZONE controls* on page 79).

15 SPEAKERS

Use to change the speaker terminal (page 79).

16 HOME MENU

Press to access the Home Menu (pages 43, 45, 73, 104, 114 and 117).

17 RETURN

Press to confirm and exit the current menu screen.

18 HDMI input connector

Use for connection to a compatible HDMI device (Video camera, etc.) (page 39).

19 iPod/iPhone/USB terminals

Use to connect your Apple iPod as an audio and video source, or connect a USB device for audio and photo playback (page 40).

20 MCACC SETUP MIC jack

Use to connect the supplied microphone (page 43).

21 PHONES jack

Use to connect headphones. When the headphones are connected, there is no sound output from the speakers.

Note

¹ Optimum Surround mode is only apply to the SC-37.

Chapter 3:

Connecting your equipment

This receiver provides you with many connection possibilities, but it doesn't have to be difficult. This chapter explains the kinds of components you can connect to make up your home theater system.

Important

- Illustration shows the SC-37, however connections for the SC-35 are the same except where noted.

Rear panel

SC-37

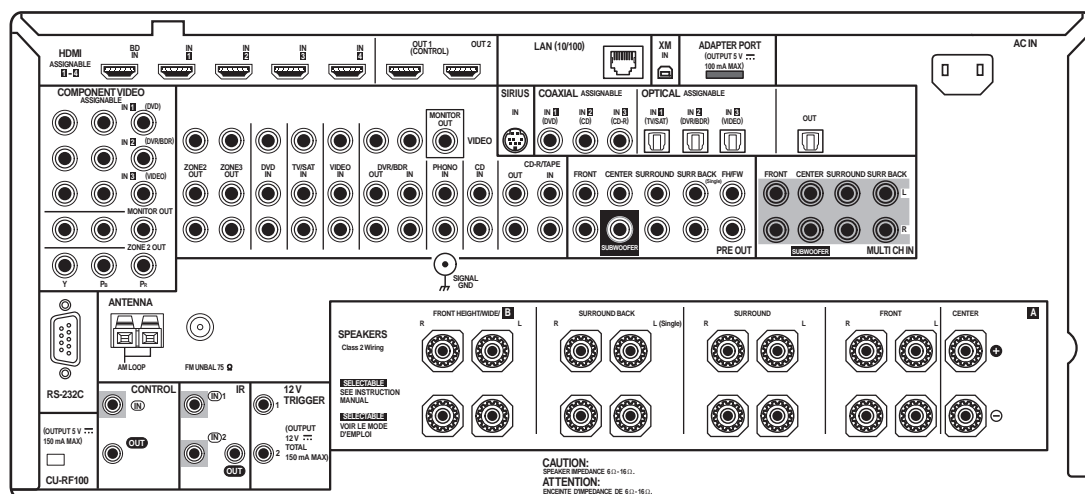

SC-35

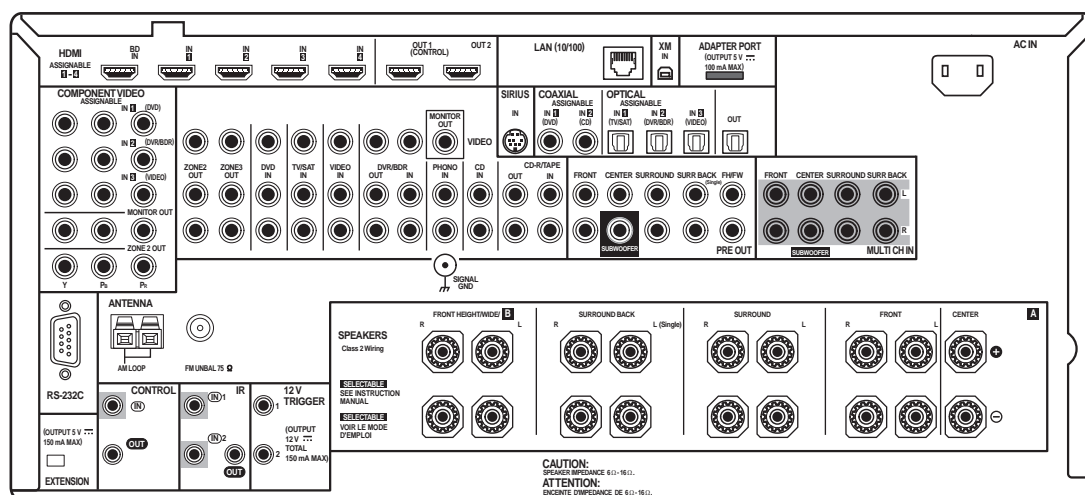

Note

- The input functions below are assigned by default to the receiver's different input terminals. Refer to *The Input Setup menu* on page 45 to change the assignments if other connections are used.

Input function	Input Terminals		
	Digital	HDMI	Component
DVD	COAX-1		IN 1
BD		(BD)	
TV/SAT	OPT-1		
DVR/BDR	OPT-2		IN 2
VIDEO	OPT-3		IN 3
HDMI 1		(HDMI-1)	
HDMI 2		(HDMI-2)	
HDMI 3		(HDMI-3)	
HDMI 4		(HDMI-4)	
HDMI 5 (front panel)		(HDMI-5)	
CD	COAX-2		
CD-R/TAPE	COAX-3 ^a		

a.SC-37 only.

- SC-35 only:* The CU-RF100 omni-directional remote control (separately sold) can be connected to the RS-232C and EXTENSION terminals. Using the CU-RF100 lets you display the receiver's display information on the remote control display in your hands and operate it without worrying about obstacles or the direction in which the remote control is pointing.

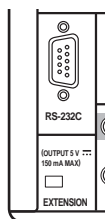

CAUTION

- Before making or changing the connections, switch off the power and disconnect the power cord from the power outlet. Plugging in should be the final step.

Connecting the RF adapter

(SC-37 only)

Two-way communications between the receiver and remote control are possible by connecting the included RF adapter to the RS-232C and CU-RF100 terminals on the receiver. For the features of two-way communications and detailed usage instructions, see *Using the RF communications function* on page 91.

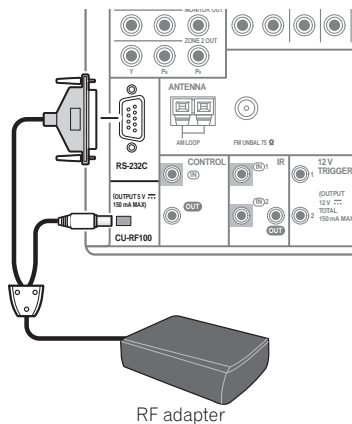

Determining the speakers' application

This unit permits you to build various surround systems, in accordance with the number of speakers you have.

- Be sure to connect speakers to the front left and right channels (**L** and **R**).
- It is also possible to only connect one of the surround back speakers (**SB**) or neither.

Choose one from Plans [A] to [E] below.

[A] 9.1 channel surround system (Front height)

*Default setting

- **Speaker System setting: Normal(SB/FH)**

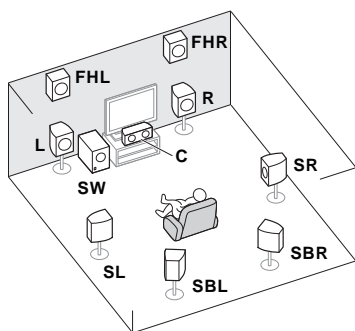

A 9.1 ch surround system connects the left and right front speakers (**L/R**), the center speaker (**C**), the left and right front height speakers (**FHL/FHR**), the left and right surround speakers (**SL/SR**), the left and right surround back speakers (**SBL/SBR**), and the subwoofer (**SW**).

This surround system produces a more true-to-life sound from above.

[B] 9.1 channel surround system (Front wide)

- **Speaker System setting: Normal(SB/FW)**

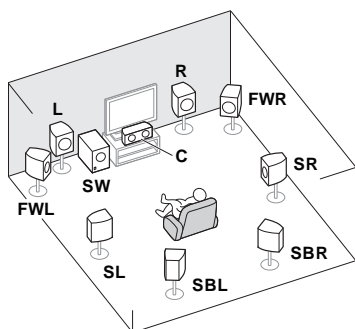

This plan replaces the left and right front height speakers shown in [A] with the left and right front wide speakers (**FWL/FWR**).

This surround system produces a true-to-life sound over a wider area.

[C] 7.1 channel surround system & Speaker B connection

- **Speaker System setting: Speaker B**

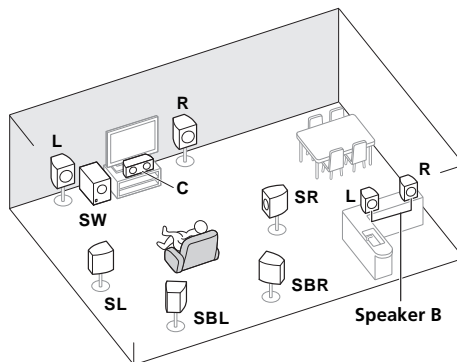

With these connections you can simultaneously enjoy 5.1-channel surround sound in the main zone with stereo playback of the same sound on the B speakers. The same connections also allow for 7.1-channel surround sound in the main zone when not using the B speakers.

[D] 5.1 channel surround system & Front Bi-amping connection (High quality surround)

- **Speaker System setting: Front Bi-Amp**

Bi-amping connection of the front speakers for high sound quality with 5.1-channel surround sound.

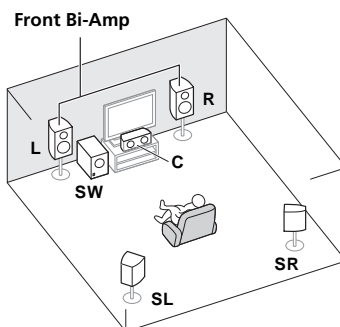

[E] 5.1 channel surround system & ZONE 2 connection (Multi Zone)

• Speaker System setting: ZONE 2

With these connections you can simultaneously enjoy 5.1-channel surround sound in the main zone with stereo playback on another component in ZONE 2. (The selection of input devices is limited.)

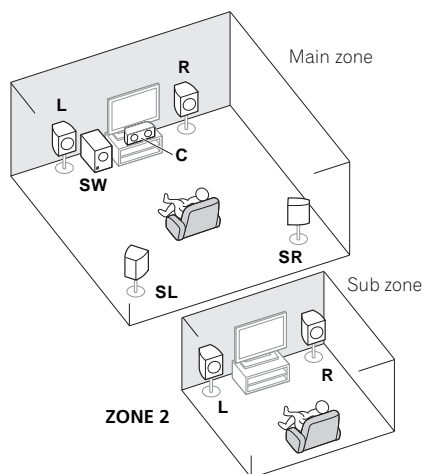

Important

- The **Speaker System** setting must be made if you use any of the connections shown above other than [A] (see *Speaker system setting* on page 115).
- Sound does not come through simultaneously from the front height, front wide, speaker B and surround back speakers. Output speakers are different depending on the input signal or listening mode.

Other speaker connections

- Your favorite speaker connections can be selected even if you have fewer than 5.1 speakers (except front left/right speakers).
- When not connecting a subwoofer, connect speakers with low frequency reproduction capabilities to the front channel. (The subwoofer's low frequency component is played from the front speakers, so the speakers could be damaged.)
- **After connecting, be sure to conduct the Full Auto MCACC (speaker environment setting) procedure.** See *Automatically conducting optimum sound tuning (Full Auto MCACC)* on page 43.

Placing the speakers

Refer to the chart below for placement of the speakers you intend to connect.

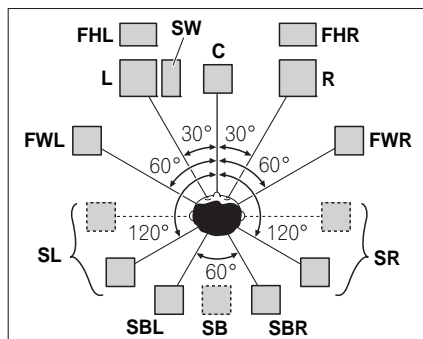

- Place the surround speakers at 120° from the center. If you, (1) use the surround back speaker, and, (2) don't use the front height speakers / front wide speakers, we recommend placing the surround speaker right beside you.
- If you intend to connect only one surround back speaker, place it directly behind you.
- Place the left and right front height speakers at least one meter (3.3 ft.) directly above the left and right front speakers.

THX speaker system setup

If you are using a THX certified subwoofer, use the **THX INPUT** jack on the subwoofer (if your subwoofer has one) or switch the filter position to **THX** on your subwoofer.

See also *THX Audio Setting* on page 117 to make the settings that will give you the best sound experience when using the Home THX modes (page 60).

Some tips for improving sound quality

Where you put your speakers in the room has a big effect on the quality of the sound. The following guidelines should help you to get the best sound from your system.

- The subwoofer can be placed on the floor. Ideally, the other speakers should be at about ear-level when you're listening to them. Putting the speakers on the floor (except the subwoofer), or mounting them very high on a wall is not recommended.
- For the best stereo effect, place the front speakers 2 m to 3 m (6 ft. to 9 ft.) apart, at equal distance from the TV.
- If you're going to place speakers around your CRT TV, use shielded speakers or place the speakers at a sufficient distance from your CRT TV.
- If you're using a center speaker, place the front speakers at a wider angle. If not, place them at a narrower angle.

- Place the center speaker above or below the TV so that the sound of the center channel is localized at the TV screen. Also, make sure the center speaker does not cross the line formed by the leading edge of the front left and right speakers.
- It is best to angle the speakers towards the listening position. The angle depends on the size of the room. Use less of an angle for bigger rooms.
- Surround and surround back speakers should be positioned 60 cm to 90 cm (2 ft. to 3 ft.) higher than your ears and tilted slightly downward. Make sure the speakers don't face each other. For DVD-Audio, the speakers should be more directly behind the listener than for home theater playback.
- Try not to place the surround speakers farther away from the listening position than the front and center speakers. Doing so can weaken the surround sound effect.

Connecting the speakers

Each speaker connection on the receiver comprises a positive (+) and negative (-) terminal. Make sure to match these up with the terminals on the speakers themselves.

⚠ CAUTION

- These speaker terminals carry **HAZARDOUS LIVE voltage**. To prevent the risk of electric shock when connecting or disconnecting the speaker cables, disconnect the power cord before touching any uninsulated parts.
- Make sure that all the bare speaker wire is twisted together and inserted fully into the speaker terminal. If any of the bare speaker wire touches the back panel it may cause the power to cut off as a safety measure.

Bare wire connections

- 1 **Twist exposed wire strands together.** (fig. A)
- 2 **Loosen terminal and insert exposed wire.** (fig. B)
- 3 **Tighten terminal.** (fig. C)

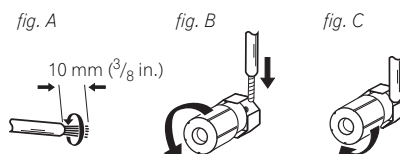

Banana plug connections

If you want to use speaker cables terminated with banana plugs, screw the speaker terminal fully shut, then plug the banana plug into the end of the speaker terminal.

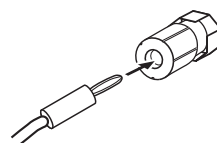

👉 Important

- Please refer to the manual that came with your speakers for details on how to connect the other end of the speaker cables to your speakers.
- Use an RCA cable to connect the subwoofer. It is not possible to connect using speaker cables.

⚠ CAUTION

- Make sure that all speakers are securely installed. This not only improves sound quality, but also reduces the risk of damage or injury resulting from speakers being knocked over or falling in the event of external shocks such as earthquakes.

Installing your speaker system

At the very least, front left and right speakers only are necessary. Note that your main surround speakers should always be connected as a pair, but you can connect just one surround back speaker if you like (it must be connected to the left surround back terminal).

Standard surround connection

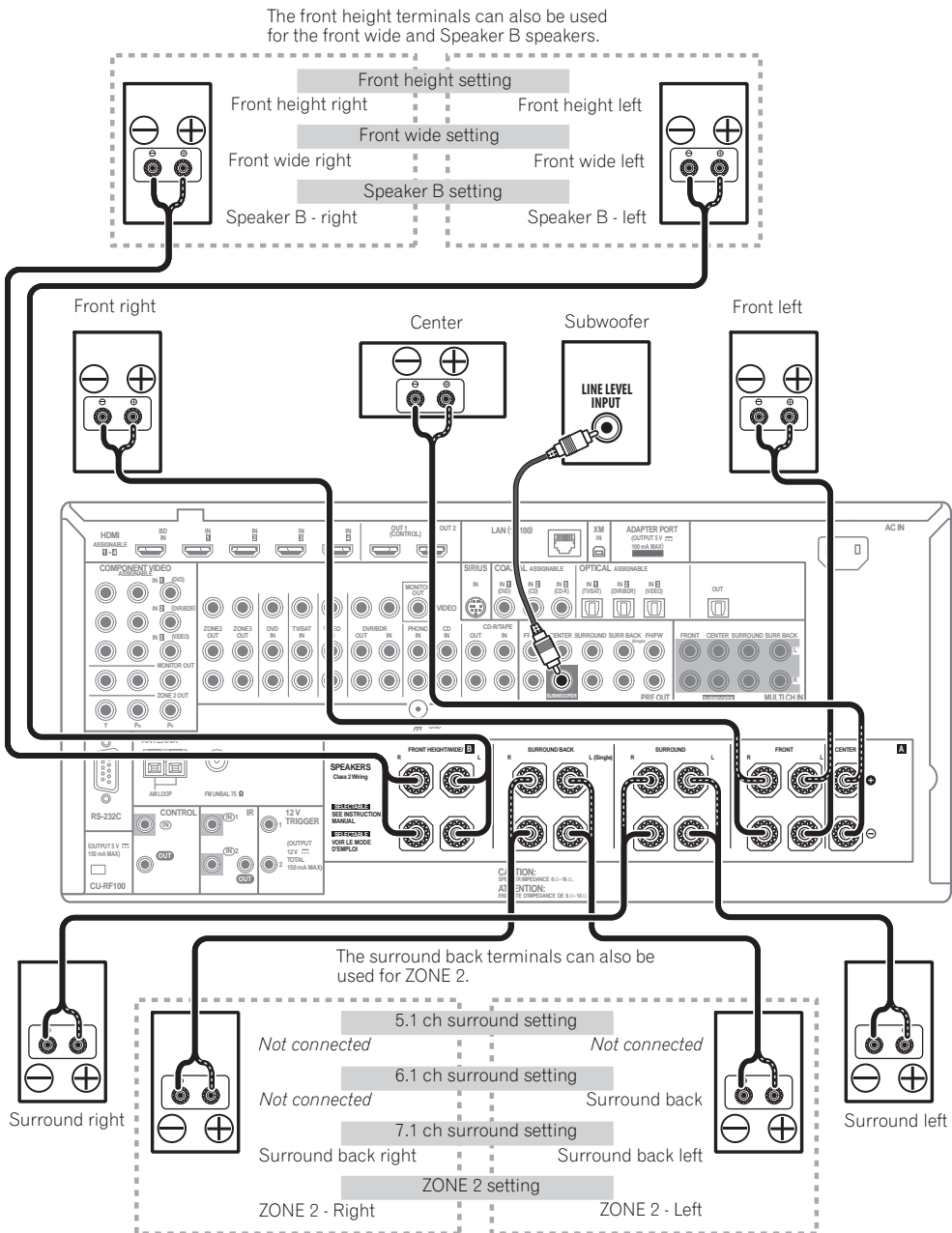

Bi-amping your speakers

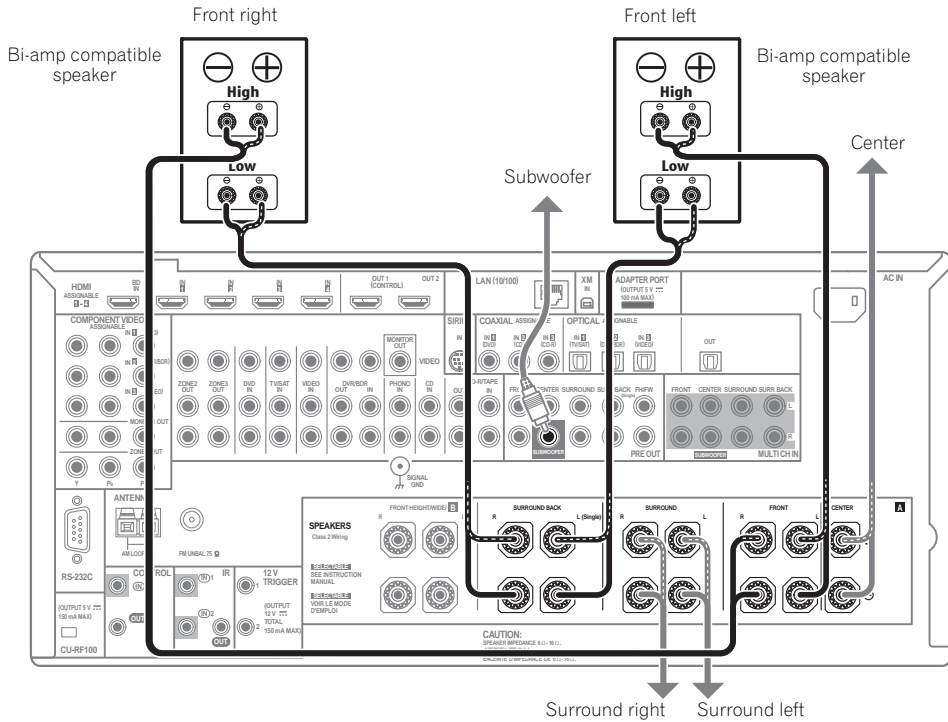

Bi-amping is when you connect the high frequency driver and low frequency driver of your speakers to different amplifiers for better crossover performance. Your speakers must be bi-ampable to do this (having separate terminals for high and low) and the sound improvement will depend on the kind of speakers you're using.

⚠ CAUTION

- Most speakers with both **High** and **Low** terminals have two metal plates that connect the **High** to the **Low** terminals. These must be removed when you are bi-amping the speakers or you could severely damage the amplifier. See your speaker manual for more information.
- If your speakers have a removable crossover network, make sure you do not remove it for bi-amping. Doing so may damage your speakers.

Bi-wiring your speakers

Your speakers can also be bi-wired if they support bi-amping.

- With these connections, the **Speaker System** setting makes no difference.
- **To bi-wire a speaker, connect two speaker cords to the speaker terminal on the receiver.** Using a banana plug for the second connection is recommended.

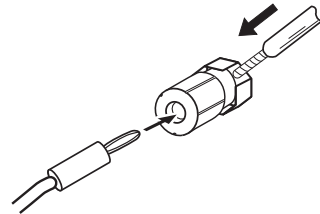

⚠ CAUTION

- Don't connect different speakers from the same terminal in this way.
- When bi-wiring as well, heed the cautions for bi-amping shown at the left.

Selecting the Speaker system

The front height terminals can be used for front wide and Speaker B connections, in addition to for the front height speakers. Also, the surround back terminals can be used for bi-amping and ZONE 2 connections, in addition to for the surround back speakers. Make this setting according to the application.

Front height setup

*Default setting

1 Connect a pair of speakers to the front height speaker terminals.

See *Standard surround connection* on page 25.

2 If necessary, select 'Normal(SB/FH)' from the Speaker System menu.

See *Speaker system setting* on page 115 to do this.

Front wide setup

1 Connect a pair of speakers to the front height speaker terminals.

See *Standard surround connection* on page 25.

2 Select 'Normal(SB/FW)' from the Speaker System menu.

See *Speaker system setting* on page 115 to do this.

Speaker B setup

You can listen to stereo playback in another room.

1 Connect a pair of speakers to the front height speaker terminals.

See *Standard surround connection* on page 25.

2 Select 'Speaker B' from the Speaker System menu.

See *Speaker system setting* on page 115 to do this.

Bi-Amping setup

Bi-amping connection of the front speakers for high sound quality with 5.1-channel surround sound.

1 Connect bi-amp compatible speakers to the front and surround back speaker terminals.

See *Bi-amping your speakers* on page 26.

2 Select 'Front Bi-Amp' from the Speaker System menu.

See *Speaker system setting* on page 115 to do this.

ZONE 2 setup

With these connections you can simultaneously enjoy 5.1-channel surround sound in the main zone with stereo playback on another component in ZONE 2.



1 Connect a pair of speakers to the surround back speaker terminals.

See *Standard surround connection* on page 25.

2 Select 'ZONE 2' from the Speaker System menu.

See *Speaker system setting* on page 115 to do this.

About the audio connection

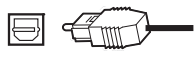
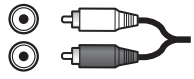
	Types of cables and terminals	Transferable audio signals
↑ Sound signal priority	HDMI 	HD audio
	Digital (Coaxial)  Digital (Optical) 	Conventional digital audio
	RCA (Analog) (White/Red) 	Conventional analog audio

- With an HDMI cable, video and audio signals can be transferred in high quality over a single cable.

About the video converter

The video converter ensures that all video sources are output through all of the **MONITOR VIDEO OUT** jacks. The only exception is HDMI: since this resolution cannot be downsampled, you must connect your monitor/TV to the receiver's HDMI video outputs when connecting this video source.¹

Note

- If the video signal does not appear on your TV, try adjusting the resolution settings on your component or display. Note that some components (such as video game units) have resolutions that may not be converted. In this case, try switching Digital Video Conversion (in *Setting the Video options* on page 78) **OFF**.
 - The signal input resolutions that can be converted from the component video input for the HDMI output are 480i/576i, 480p/576p, 720p and 1080i. 1080p signals cannot be converted.
 - Only signals with an input resolution of 480i/576i can be converted from the component video input for the composite **MONITOR OUT** terminals.

If several video components are assigned to the same input function (see *The Input Setup menu* on page 45), the converter gives priority to HDMI, component, then composite (in that order).

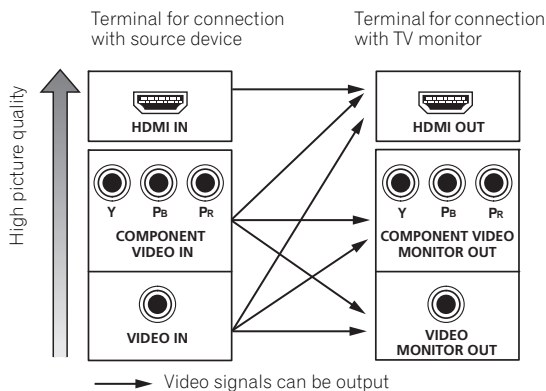

- For optimal video performance, THX recommends switching Digital Video Conversion (in *Setting the Video options* on page 78) **OFF**.

This product incorporates copyright protection technology that is protected by U.S. patents and other intellectual property rights. Use of this copyright protection technology must be authorized by Rovi Corporation, and is intended for home and other limited viewing uses only unless otherwise authorized by Rovi Corporation. Reverse engineering or disassembly is prohibited.

About HDMI¹

The HDMI connection transfers uncompressed digital video, as well as almost every kind of digital audio.

This receiver incorporates High-Definition Multimedia Interface (HDMI[®]) technology.

This receiver supports the functions described below through HDMI connections.²

- Digital transfer of uncompressed video (contents protected by HDCP (1080p/24, 1080p/60, etc.))
- 3D signal transfer³
- Deep Color signal transfer³
- x.v.Color signal transfer³
- Audio Return Channel³
- Input of multi-channel linear PCM digital audio signals (192 kHz or less) for up to 8 channels
- Input of the following digital audio formats:⁴
 - Dolby Digital, Dolby Digital Plus, DTS, High bitrate audio (Dolby TrueHD, DTS-HD Master Audio, DTS-HD High Resolution Audio), DVD-Audio, CD, SACD (DSD signal), Video CD, Super VCD
- Synchronized operation with components using the **Control** with HDMI function (see *Control with HDMI function* on page 72)

HDMI, the HDMI logo and High-Definition Multimedia Interface are trademarks or registered trademarks of HDMI Licensing, LLC in the United States and other countries.

"x.v.Color" and x.v.Color logo are trademarks of Sony Corporation.

Note

- An HDMI connection can only be made with DVI-equipped components compatible with both DVI and High Bandwidth Digital Content Protection (HDCP). If you choose to connect to a DVI connector, you will need a separate adaptor (DVI→HDMI) to do so. A DVI connection, however, does not support audio signals. Consult your local audio dealer for more information.
 - If you connect a component that is not compatible with HDCP, an **HDCP ERROR** message is displayed on the front panel display. Some components that are compatible with HDCP still cause this message to be displayed, but so long as there is no problem with displaying video this is not a malfunction.
 - Depending on the component you have connected, using a DVI connection may result in unreliable signal transfers.
 - This receiver supports SACD, Dolby Digital Plus, Dolby TrueHD and DTS-HD Master Audio. To take advantage of these formats, however, make sure that the component connected to this receiver also supports the corresponding format.
- Use a High Speed HDMI[®] cable. If an HDMI cable other than a High Speed HDMI[®] cable is used, it may not work properly.
 - When an HDMI cable with a built-in equalizer is connected, it may not operate properly.
- Signal transfer is only possible when connected to a compatible component.
- HDMI format digital audio transmissions require a longer time to be recognized. Due to this, interruption in the audio may occur when switching between audio formats or beginning playback.
 - Turning on/off the device connected to this unit's HDMI OUT terminal during playback, or disconnecting/connecting the HDMI cable during playback, may cause noise or interrupted audio.

Connecting your TV and playback components

Connecting using HDMI

If you have an HDMI or DVI (with HDCP) equipped component (Blu-ray disc player (BD), etc.), you can connect it to this receiver using a commercially available HDMI cable.

If the TV and playback components support the **Control with HDMI** feature, the convenient **Control with HDMI** functions can be used (see *Control with HDMI function* on page 72).

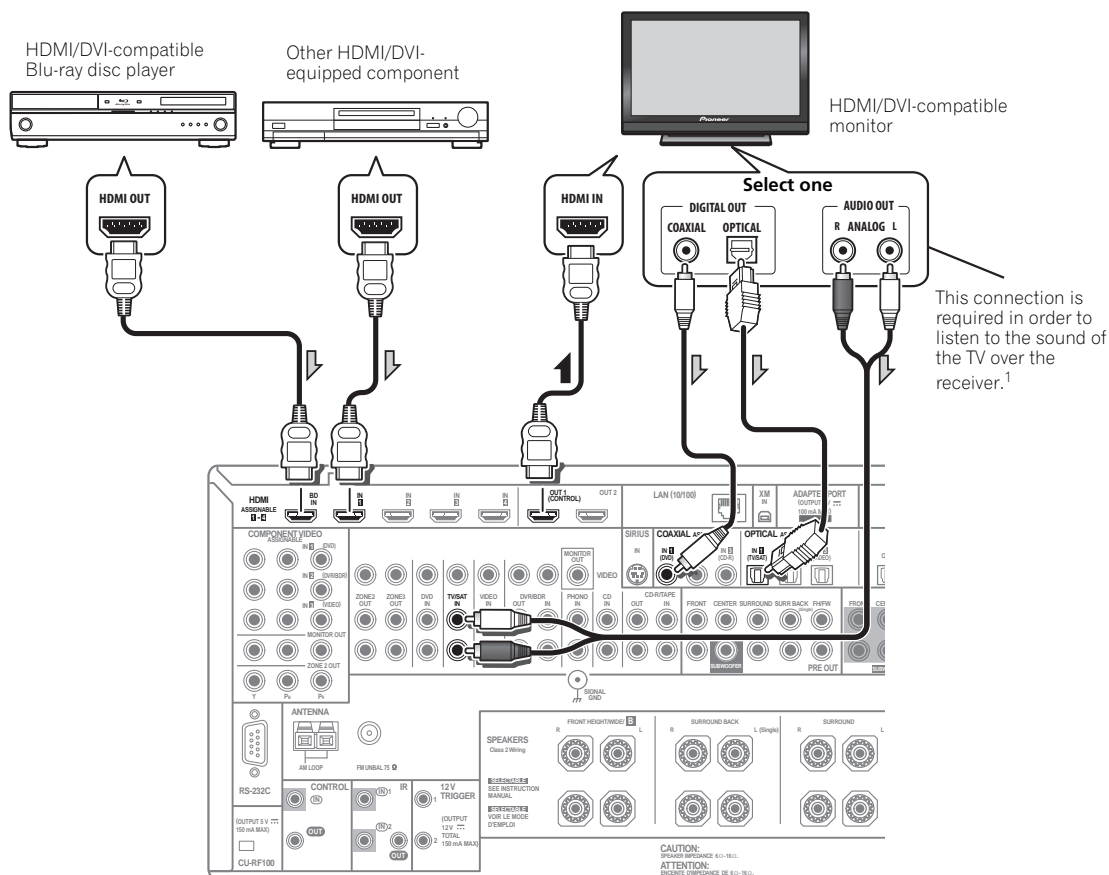

- When connecting to an HDMI/DVI-compatible monitor using the **HDMI OUT 2** terminal, switch the HDMI output setting to **HDMI OUT 2** or **HDMI OUT ALL**. See *Switching the HDMI output* on page 81.
- For input components, connections other than HDMI connections are also possible (see *Connecting your DVD player with no HDMI output* on page 30).
- If you want to listen to the sound of the TV over the receiver, connect the receiver and TV with audio cables.¹

Note

¹ When the TV and receiver are connected by HDMI connections, if the TV supports the HDMI Audio Return Channel function, the sound of the TV is input to the receiver via the HDMI terminal, so there is no need to connect an audio cable. In this case, set **TV Audio** at **HDMI Setup** to **via HDMI** (see *HDMI Setup* on page 73).

Connecting your DVD player with no HDMI output

This diagram shows connections of a TV (with HDMI input) and DVD player (or other playback component with no HDMI output) to the receiver.

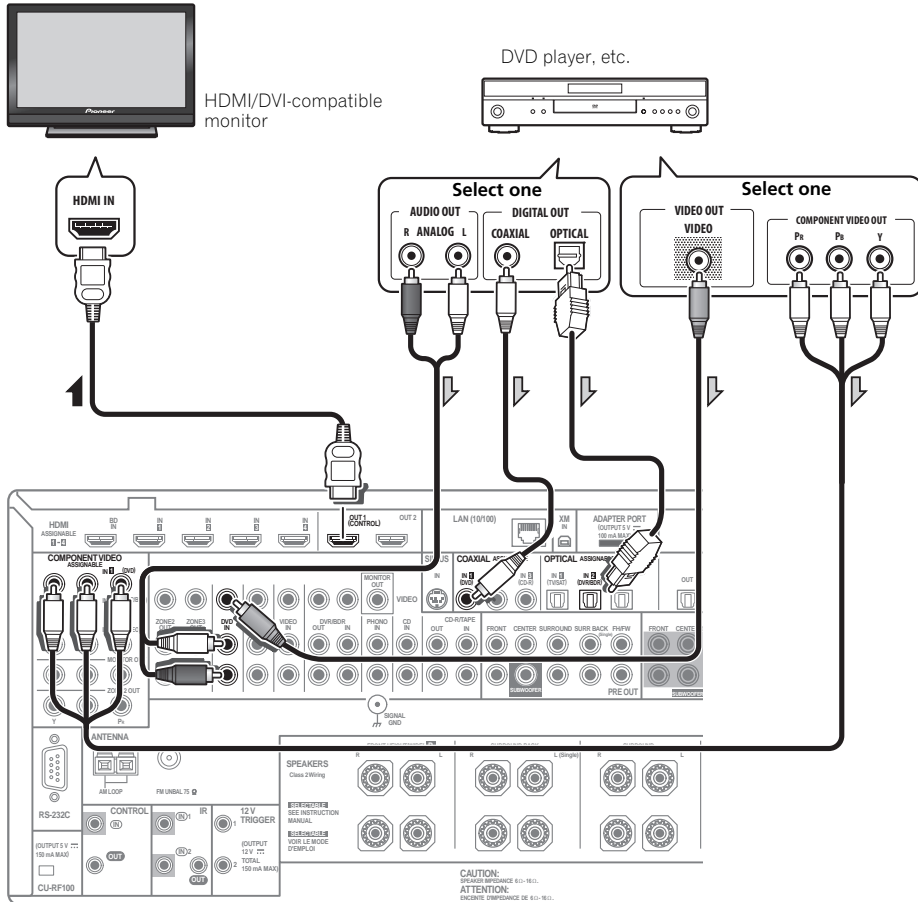

- If you want to listen to the sound of the TV over the receiver, connect the receiver and TV with audio cables (page 29).¹
- If you use an optical digital audio cable, you'll need to tell the receiver which digital input you connected the player to (see *The Input Setup menu* on page 45).

Note

¹ When the TV and receiver are connected by HDMI connections, if the TV supports the HDMI Audio Return Channel function, the sound of the TV is input to the receiver via the HDMI terminal, so there is no need to connect an audio cable. In this case, set **TV Audio** at **HDMI Setup** via **HDMI** (see *HDMI Setup* on page 73).

Connecting your TV with no HDMI input

This diagram shows connections of a TV (with no HDMI input) and DVD player (or other playback component) to the receiver.

- With these connections, the picture is not output to the TV even if the DVD player is connected with an HDMI cable. Connect the DVD player's video signals using a composite or component cord.

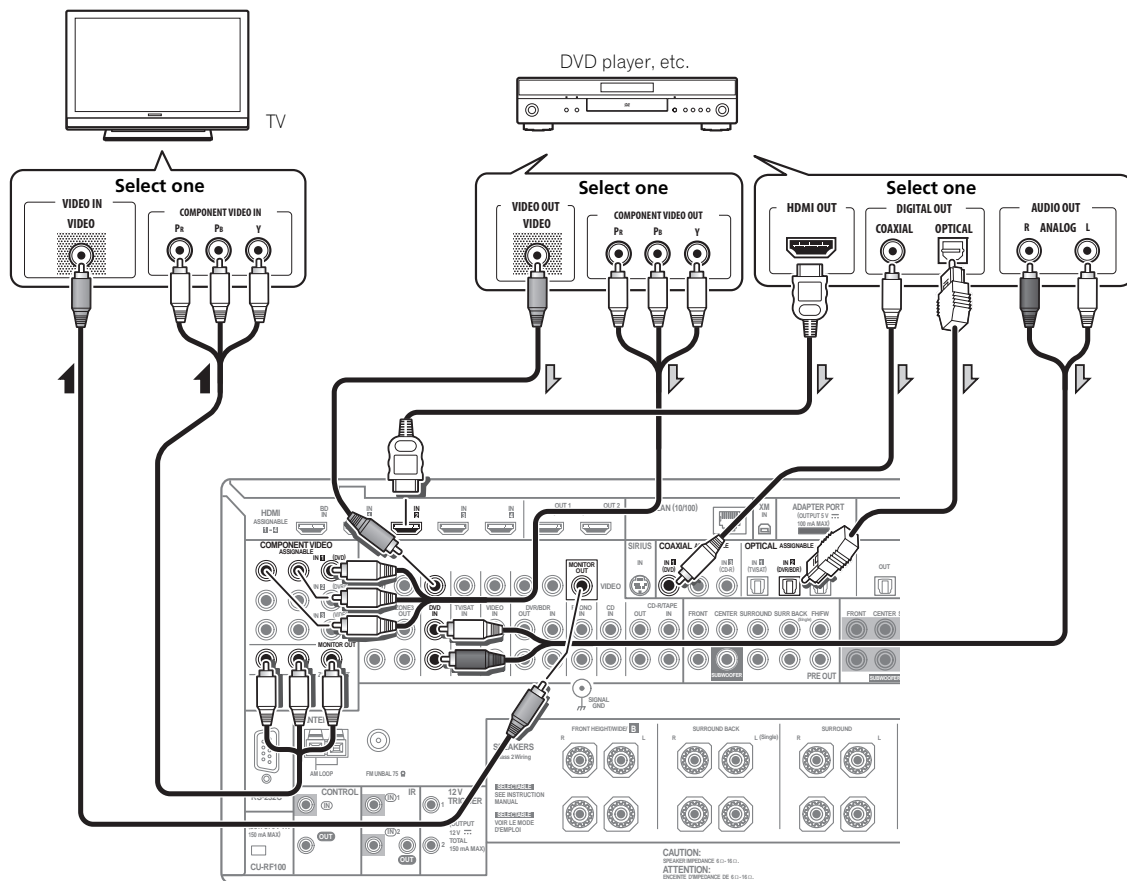

- Connect using an HDMI cable to listen to HD audio on the receiver. Do not use an HDMI cable to input video signals. Depending on the video component, it may not be possible to output signals connected by HDMI and other methods simultaneously, and it may be necessary to make output settings. Please refer to the operating instructions supplied with your component for more information.
- If you want to listen to the sound of the TV over the receiver, connect the receiver and TV with audio cables (page 29).
- If you use an optical digital audio cable, you'll need to tell the receiver which digital input you connected the player to (see *The Input Setup menu* on page 45).

Connecting an HDD/DVD recorder, BD recorder and other video sources

This receiver has two sets of audio/video inputs and outputs suitable for connecting analog or digital video devices, including HDD/DVD recorders and BD recorders.

When you set up the receiver you'll need to tell the receiver which input you connected the recorder to (see also *The Input Setup menu* on page 45).

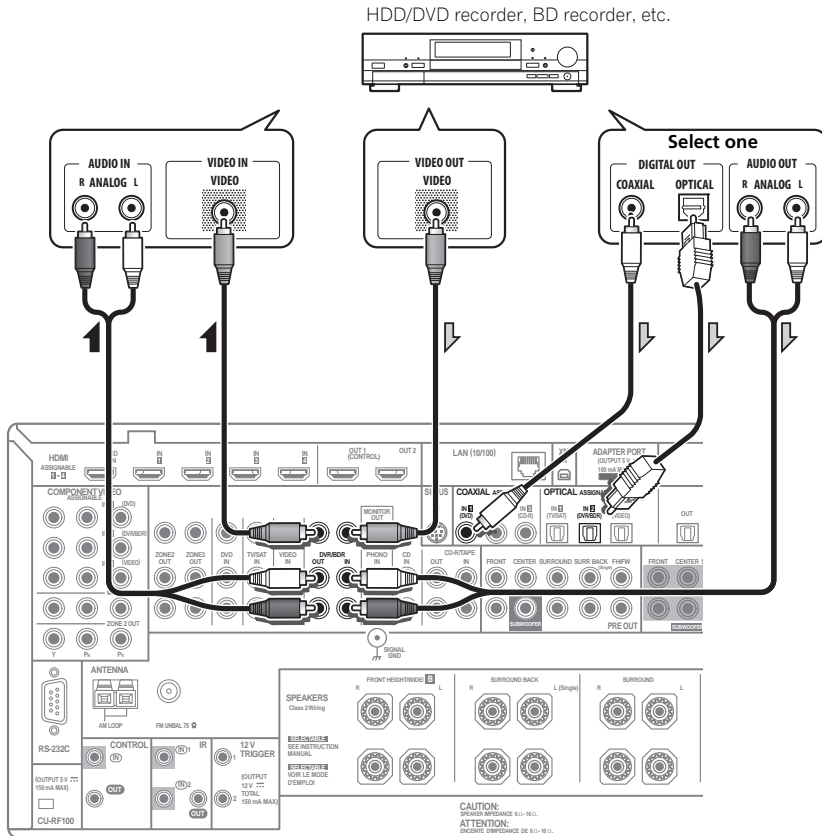

- In order to record, you must connect the analog audio cables (the digital connection is for playback only) (page 80).
- If your HDD/DVD recorder, BD recorder, etc., is equipped with an HDMI output terminal, we recommend connecting it to the receiver's **HDMI IN** terminal. When doing so, also connect the receiver and TV by HDMI (see *Connecting using HDMI* on page 29).

Connecting a satellite/cable receiver or other set-top box

Satellite and cable receivers, and terrestrial digital TV tuners are all examples of so-called 'set-top boxes'.

When you set up the receiver you'll need to tell the receiver which input you connected the set-top box to (see *The Input Setup menu* on page 45).

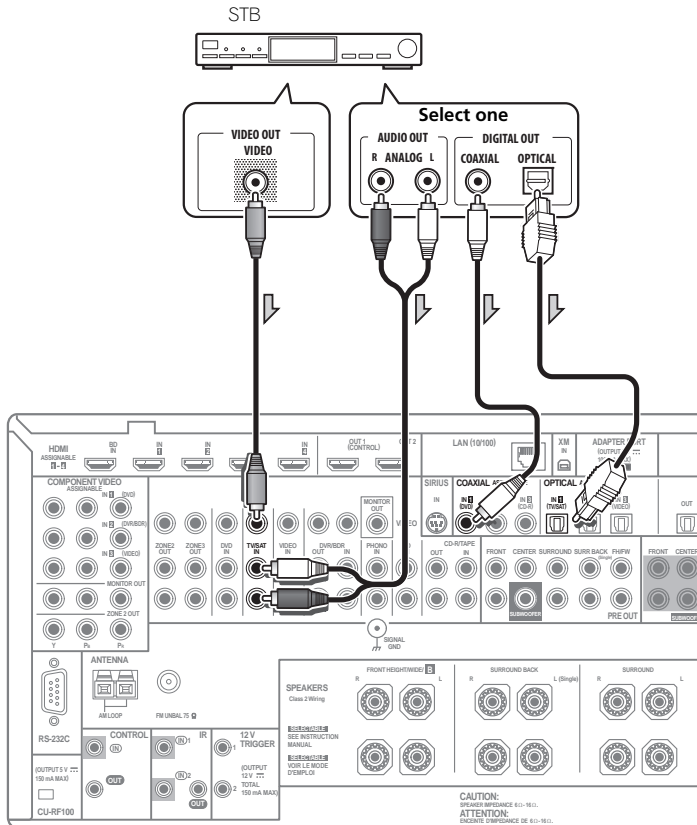

- If your set-top box is equipped with an HDMI output terminal, we recommend connecting it to the receiver's **HDMI IN** terminal. When doing so, also connect the receiver and TV by HDMI (see *Connecting using HDMI* on page 29).

Connecting the multichannel analog inputs

For DVD Audio and SACD playback, your DVD player may have 5.1, 6.1 or 7.1 channel analog outputs (depending on whether your player supports surround back channels). Make sure that the player is set to output multichannel analog audio.

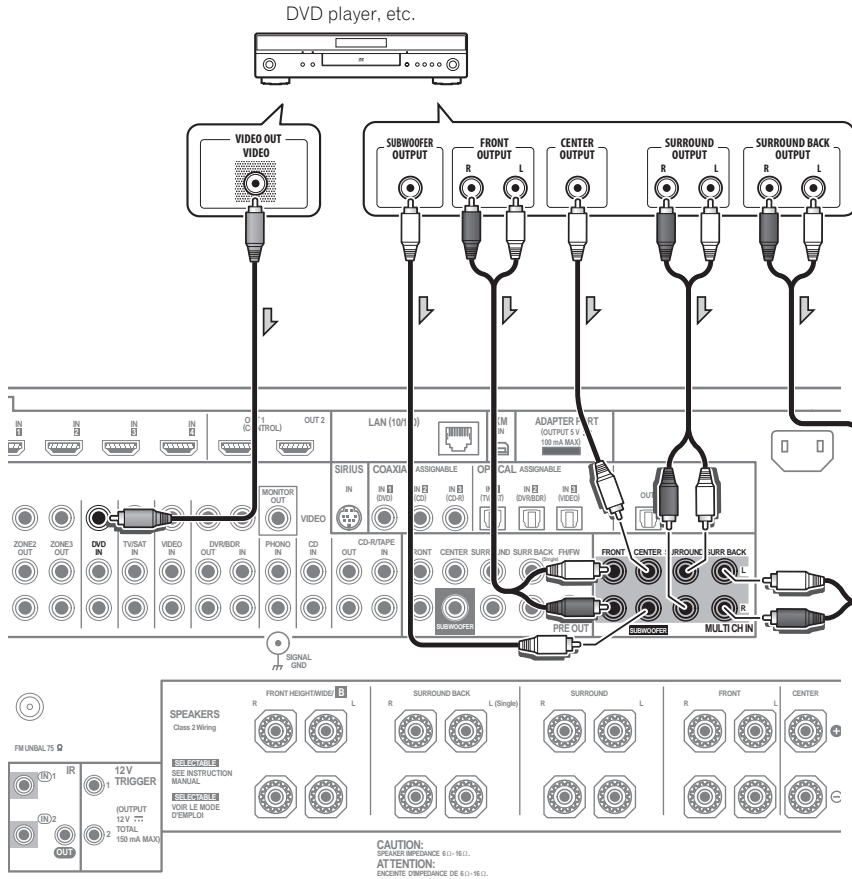

- If there is a single surround back output, connect it to the **SURROUND BACK L** jack on this receiver.
- To use a 5.1-channel speaker set, use the surround speakers for the surround channel, not the surround back channel.
- The audio signal input to **MULTI CH IN** cannot be downmixed.

Connecting other audio components

This receiver has both digital and analog inputs, allowing you to connect audio components for playback.

Most digital components also have analog connections.

When you set up the receiver you'll need to tell the receiver which input you connected the component to (see also *The Input Setup menu* on page 45).

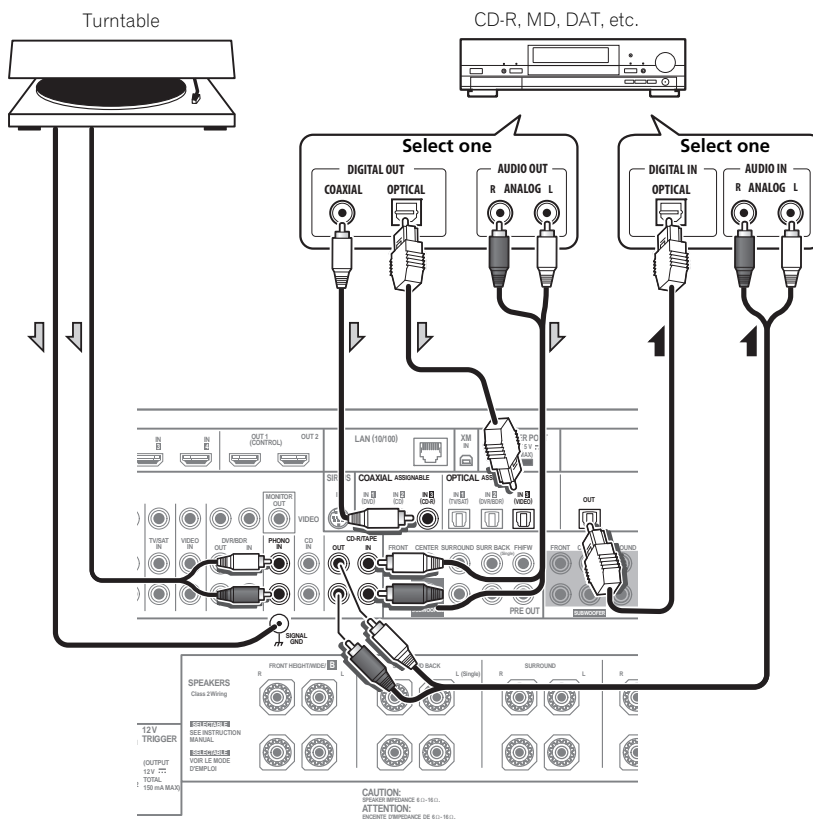

- If you're connecting a recorder, connect the analog audio outputs to the analog audio inputs on the recorder.
- You can't hear HDMI audio through this receiver's digital out jack.

Turntables only:

- If your turntable has a grounding wire, secure it to the ground terminal on this receiver.
- If your turntable has line-level outputs (i.e., it has a built-in phono pre-amp), connect it to the **CD** inputs instead.

About the WMA9 Pro decoder

This unit has an on-board Windows Media™ Audio 9 Professional¹ (WMA9 Pro) decoder, so it is possible to playback WMA9 Pro-encoded audio using HDMI, coaxial or optical digital connection when connected to a WMA9 Pro-compatible player. However, the connected DVD player, set-top box, etc. must be able to output WMA9 Pro format audio signals through a coaxial or optical digital output.

Note

- Windows Media and the Windows logo are trademarks or registered trademarks of Microsoft Corporation in the United States and/or other countries.
- With WMA9 Pro, sound problems may occur depending on your computer system. Note that WMA9 Pro 96 kHz sources will be downsampled to 48 kHz.

Connecting additional amplifiers

This receiver has more than enough power for any home use, but it's possible to add additional amplifiers to every channel of your system using the pre-outs. Make the connections shown below to add amplifiers to power your speakers.

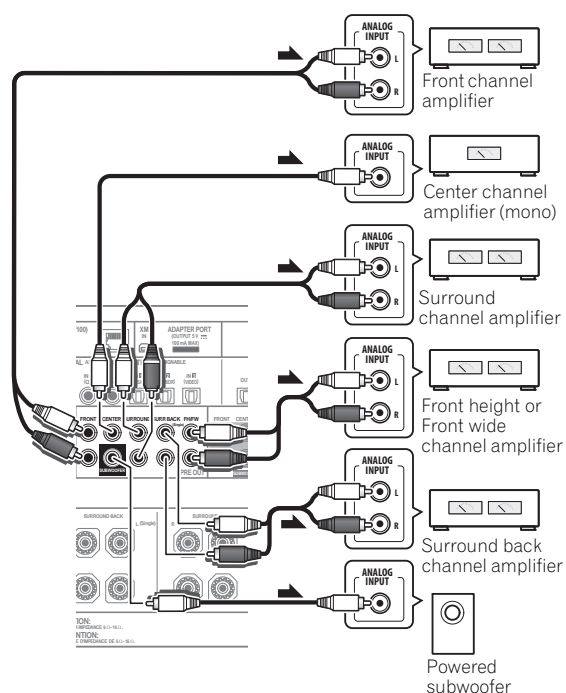

- You can use the additional amplifier on the surround back channel pre-outs for a single speaker as well. In this case plug the amplifier into the left (**L (Single)**) terminal only.
- The sound from the surround back terminals will depend on how you have configured the *Speaker system setting* on page 115.
- To hear sound only from the pre-outs, switch the speaker system to **OFF**, or simply disconnect any speakers that are connected directly to the receiver.

If you're not using a subwoofer, change the front speaker setting (see *Speaker Setting* on page 115) to **LARGE**.

Connecting AM/FM antennas

Connect the AM loop antenna and the FM wire antenna as shown below. To improve reception and sound quality, connect external antennas (see *Connecting external antennas* on page 37).

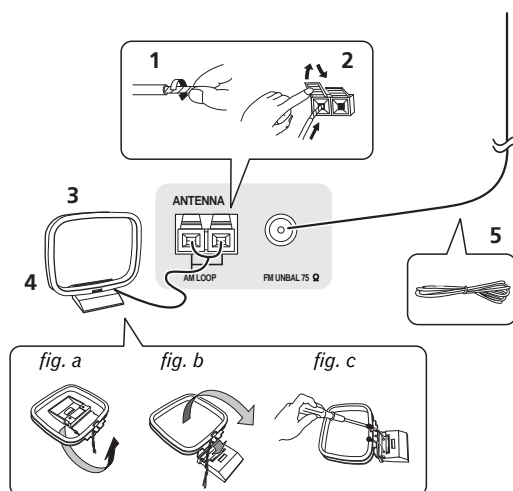

1 Pull off the protective shields of both AM antenna wires.

2 Push open the tabs, then insert one wire fully into each terminal, then release the tabs to secure the AM antenna wires.

3 Fix the AM loop antenna to the attached stand.

To fix the stand to the antenna, bend in the direction indicated by the arrow (*fig. a*) then clip the loop onto the stand (*fig. b*).

- If you plan to mount the AM antenna to a wall or other surface, secure the stand with screws (*fig. c*) before clipping the loop to the stand. Make sure the reception is clear.

4 Place the AM antenna on a flat surface and in a direction giving the best reception.

5 Connect the FM wire antenna into the FM antenna socket.

For best results, extend the FM antenna fully and fix to a wall or door frame. Don't drape loosely or leave coiled up.

Connecting external antennas

To improve FM reception, connect an external FM antenna to **FM UNBAL 75 Ω**.

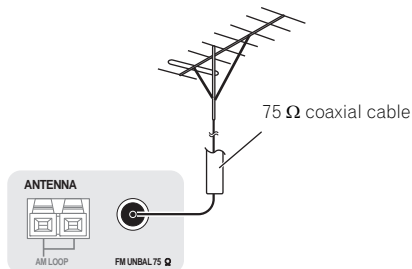

To improve AM reception, connect a 5 m to 6 m (16 ft. to 20 ft.) length of vinyl-coated wire to the **AM LOOP** terminals without disconnecting the supplied AM loop antenna.

For the best possible reception, suspend horizontally outdoors.

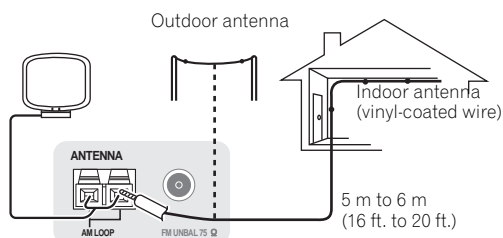

MULTI-ZONE setup

This receiver can power up to three independent systems in separate rooms after you have made the proper MULTI-ZONE connections.

Different sources can be playing in three zones at the same time or, depending on your needs, the same source can also be used. The main and sub zones have independent power (the main zone power can be off while one (or both) of the sub zones is on) and the sub zones can be controlled by the remote or front panel controls.

Making MULTI-ZONE connections

It is possible to make these connections if you have a separate TV and speakers for your primary (**ZONE 2**) sub zone, and a separate TV and a separate amplifier (and speakers) for your secondary (**ZONE 3**) sub zone. You will also need a separate amplifier if you are not using the *MULTI-ZONE setup using speaker terminals (ZONE 2)* on page 38 for your primary sub zone. There are two primary sub zone setups possible with this system. Choose whichever works best for you.

MULTI-ZONE listening options

The following table shows the signals that can be output to ZONE 2 and ZONE 3¹:

Sub Zone	Input functions available
ZONE 2	DVD, TV/SAT, DVR/BDR, VIDEO, HOME MEDIA GALLERY (SC-37 only), INTERNET RADIO (SC-35 only), iPod/USB, XM RADIO, CD, CD-R/TAPE, TUNER, ADAPTER PORT, SIRIUS (Outputs analog audio, composite video and component video.)
ZONE 3	Same as ZONE 2 above. (Outputs analog audio and composite video.)

Basic MULTI-ZONE setup (ZONE 2)

- **Connect a separate amplifier to the AUDIO ZONE 2 OUT jacks and a TV monitor to the VIDEO ZONE 2 OUT² jack, both on this receiver.**

You should have a pair of speakers attached to the sub zone amplifier as shown in the following illustration.

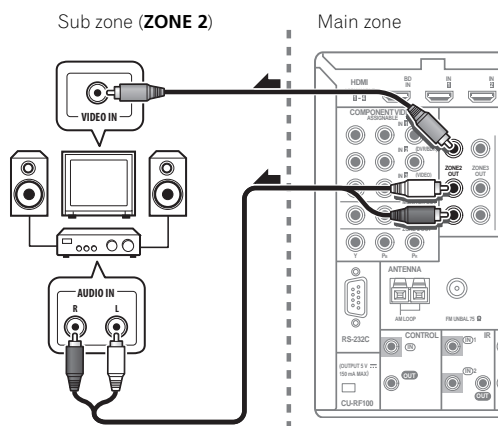

Note

¹ For the INTERNET RADIO (SC-35 only), HOME MEDIA GALLERY (SC-37 only), XM RADIO, SIRIUS and iPod/USB inputs, it is not possible use the same input in ZONE 2 and ZONE 3 simultaneously.

² • **COMPONENT VIDEO ZONE 2 OUT** can be used to output clear images.

- The GUI screen is not displayed if only the **COMPONENT VIDEO ZONE 2 OUT** jack is connected.

- The GUI convert function does not work for ZONE 2. Connect the composite video and component video to the same types of jacks for the inputs and outputs.

MULTI-ZONE setup using speaker terminals (ZONE 2)

You must select **ZONE 2** in *Speaker system setting* on page 115 to use this setup.

- Connect a TV monitor to the **VIDEO ZONE 2 OUT** jacks on this receiver.¹

You should have a pair of speakers attached to the surround back speaker terminals as shown below.

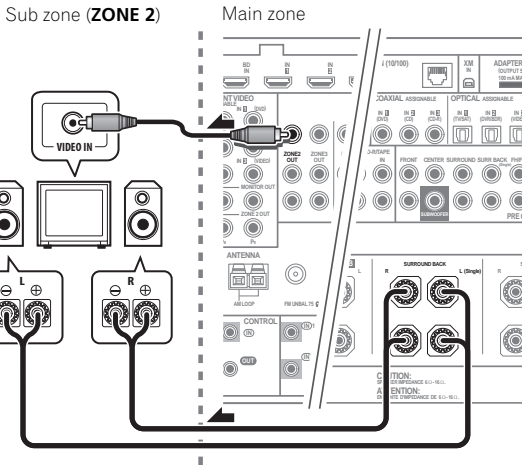

Secondary MULTI-ZONE setup (ZONE 3)

- Connect a separate amplifier to the **AUDIO ZONE 3 OUT** jacks and a TV monitor to the **VIDEO ZONE 3 OUT** jack, both on this receiver.

You should have a pair of speakers attached to the sub zone amplifier as shown in the following illustration.

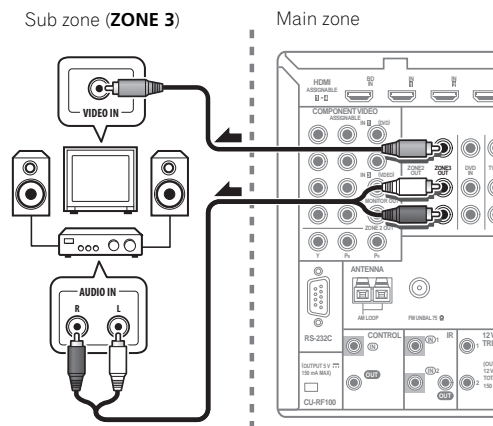

Connecting to the network through LAN interface

By connecting this receiver to the network via the LAN terminal, you can listen to Internet radio stations.²

SC-37 only: When connected in this way, you can play audio files stored on the components on the network, including your computer, using HOME MEDIA GALLERY inputs.³

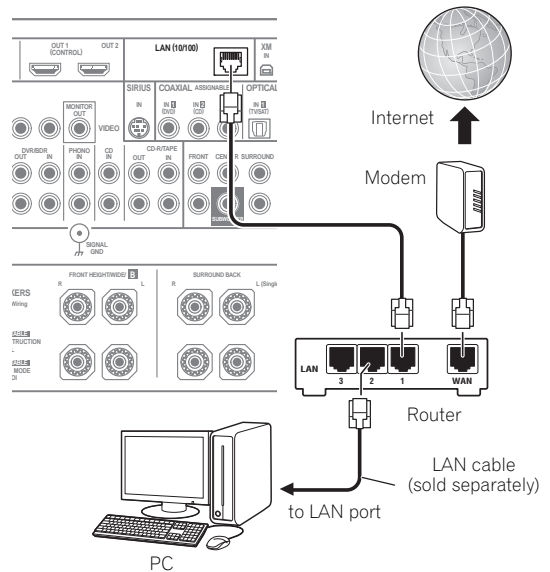

Connect the LAN terminal on this receiver to the LAN terminal on your router (with or without the built-in DHCP server function) with a straight LAN cable (CAT 5 or higher).

Turn on the DHCP server function of your router. In case your router does not have the built-in DHCP server function, it is necessary to set up the network manually. For details, see *Network Setup menu* on page 117.

LAN terminal specifications

LAN terminal Ethernet jack
10BASE-T/100BASE-TX

Note

- **COMPONENT VIDEO ZONE 2 OUT** can be used to output clear images.
 - The GUI screen is not displayed if only the **COMPONENT VIDEO ZONE 2 OUT** jack is connected.
 - The video convert function does not work for ZONE 2. Connect the composite video and component video to the same types of jacks for the inputs and outputs.
- To listen to Internet radio stations, you must sign a contract with an ISP (Internet Service Provider) beforehand.
- Photo or video files cannot be played back.
 - With Windows Media Player 11 or Windows Media Player 12, you can even play back copyrighted audio files on this receiver.

Connecting Optional **Bluetooth® ADAPTER**

When the *Bluetooth* ADAPTER (Pioneer Model No. AS-BT100)¹ is connected to this receiver, a product equipped with *Bluetooth* wireless technology (portable cell phone, digital music player, etc.) can be used to listen to music wirelessly.²

Bluetooth® ADAPTER (sold separately)

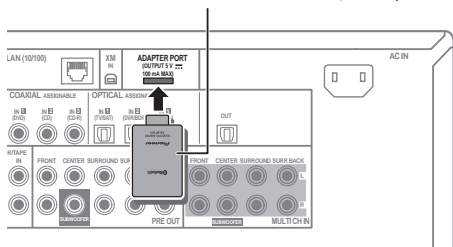

- Switch the receiver into standby and connect **Bluetooth ADAPTER** to the **ADAPTER PORT**.
- For instructions on playing the *Bluetooth* wireless technology device, see *Pairing the Bluetooth ADAPTER and Bluetooth wireless technology device* on page 58.

Important

- Do not move the receiver with the *Bluetooth* ADAPTER connected. Doing so could cause damage or faulty contact.

Connecting an HDMI-equipped component to the front panel input

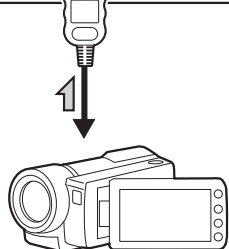
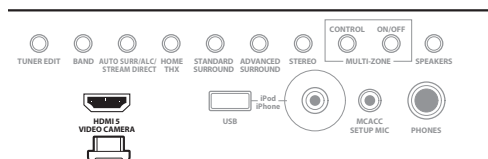

Note

- 1 The *Bluetooth* ADAPTER (AS-BT100) is sold separately.
 - 2 • The *Bluetooth* wireless technology enabled device must support A2DP profiles.
- Pioneer does not guarantee proper connection and operation of this unit with all *Bluetooth* wireless technology enabled devices.

Connecting an XM Radio tuner

After purchasing an XM Mini-Tuner and Home Dock (both sold separately), you will also need to activate the XM Radio service to begin receiving broadcasts.

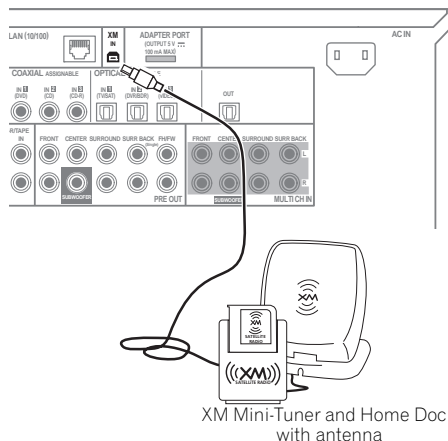

- For instructions on playing the XM Radio, see *Listening to XM Radio* on page 53.

Connecting a SiriusConnect™ tuner

To receive SIRIUS Satellite Radio broadcasts, you will need to activate your SiriusConnect™ tuner.

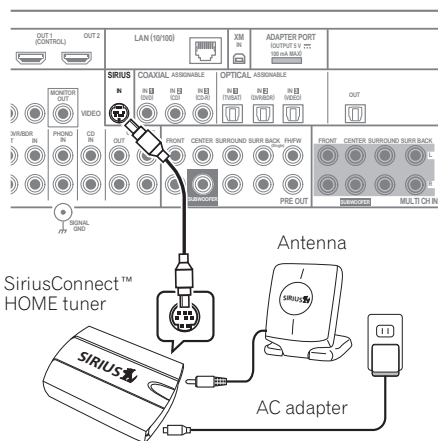

You will also need to connect the antenna and AC adapter to the SiriusConnect™ tuner.

For instructions on playing the SIRIUS Radio, see *Listening to SIRIUS Radio* on page 54.

Connecting an iPod

This receiver has a dedicated iPod terminal that will allow you to control playback of audio content from your iPod using the controls of this receiver.

- **Switch the receiver into standby then use the supplied iPod cable to connect your iPod to the iPod/iPhone/USB terminal on the front panel of this receiver.**

- It is also possible to connect using the cable included with the iPod, but in this case it is not possible to view pictures via the receiver.
- For the cable connection, also refer to the operating instructions for your iPod.
- For instructions on playing the iPod, see *Playing an iPod* on page 48.

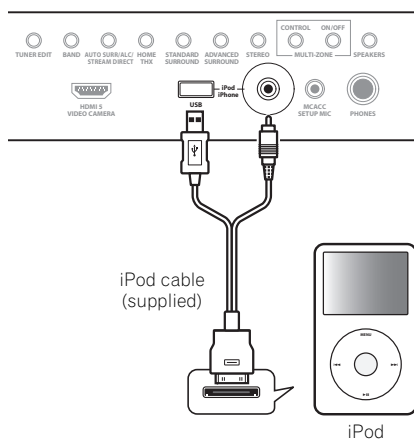

Connecting a USB device

It is possible to play audio and photo files by connecting USB devices to this receiver. It is also possible to connect a USB keyboard (US-international layout) to the receiver to enter text in the following GUI screens.

- Change the input name in the **Input Setup** menu (page 45).
- Add names to radio station presets (page 52).
- *SC-35 only*: Enter Internet radio station URLs (page 56).

- **Switch the receiver into standby then connect your USB device to the USB terminal on the front panel of this receiver.**¹

- For instructions on playing the USB device, see *Playing a USB device* on page 49.

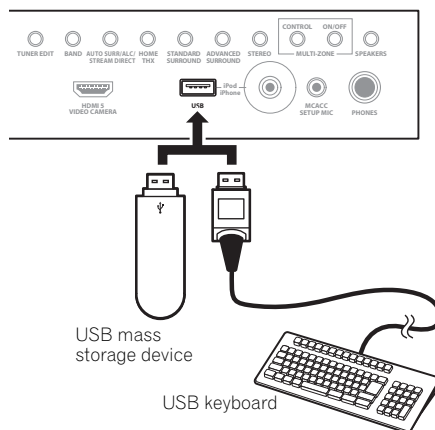

Connecting a USB device for Advanced MCACC output

When using Full Auto MCACC (page 43), Auto MCACC (page 104) or Acoustic Calibration EQ Professional (page 108) to calibrate the reverb characteristics of your listening room, the 3D graphs of the reverb characteristics in your listening room (before and after calibration) can be checked on a computer screen. *SC-37 only*: Also, the speakers' group delay characteristics before and after calibration can be checked on 3D graphs.

The various MCACC parameters can also be checked on the computer. MCACC data and parameters are transferred from this receiver to a USB device and by connecting the USB device to a computer, the data is imported via the MCACC software in the computer.

The MCACC software to output the results is available from the support area of the Pioneer website (<http://www.pioneerelectronics.com/PUSA/Home+Entertainment+Custom+Install>). Instructions for using the software are also available here. If you have any questions regarding, please contact the Customer Support Division of Pioneer.

See the documentation provided with the Advanced MCACC PC Display Application Software for more information.

- For the USB device connection and operations, see *Output MCACC data* on page 112².

Note

¹ This receiver does not support a USB hub.

² The various parameters and the reverb characteristics data used for display on the computer are not cleared when the power is turned off (see *Output MCACC data* on page 112).

Connecting an IR receiver

If you keep your stereo components in a closed cabinet or shelving unit, or you wish to use the sub zone remote control in another zone, you can use an optional IR receiver (such as a Niles or Xantech unit) to control your system instead of the remote sensor on the front panel of this receiver.¹

1 Connect the IR receiver sensor to the IR IN jack on the rear of this receiver.

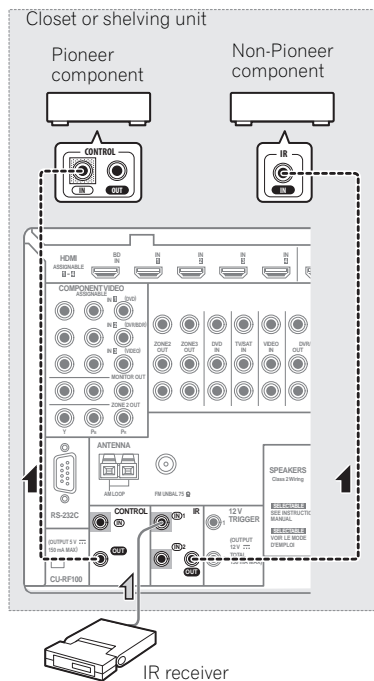

2 Connect the IR IN jack of another component to the IR OUT jack on the rear of this receiver to link it to the IR receiver.

Please see the manual supplied with your IR receiver for the type of cable necessary for the connection.

- If you want to link a Pioneer component to the IR receiver, see *Operating other Pioneer components with this unit's sensor* below to connect to the **CONTROL** jacks instead of the **IR OUT** jack.

Operating other Pioneer components with this unit's sensor

Many Pioneer components have **SR CONTROL** jacks which can be used to link components together so that you can use just the remote sensor of one component. When you use a remote control, the control signal is passed along the chain to the appropriate component.²

Important

- Note that if you use this feature, *make sure that you also have at least one set of analog audio, video or HDMI jacks connected to another component for grounding purposes.*

1 Decide which component you want to use the remote sensor of.

When you want to control any component in the chain, this is the remote sensor at which you'll point the corresponding remote control.

2 Connect the CONTROL OUT jack of that component to the CONTROL IN jack of another Pioneer component.

Use a cable with a mono mini-plug on each end for the connection.

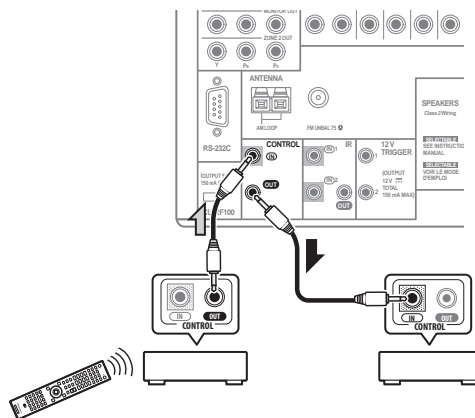

Continue the chain in the same way for as many components as you have.

Note

- Remote operation may not be possible if direct light from a strong fluorescent lamp is shining on the IR receiver remote sensor window.
 - Note that other manufacturers may not use the IR terminology. Refer to the manual that came with your component to check for IR compatibility.
- If using two remote controls (at the same time), the IR receiver's remote sensor takes priority over the remote sensor on the front panel.
 - If you want to control all your components using this receiver's remote control, see *Setting the remote to control other components* on page 84 (SC-37)/page 97 (SC-35).
 - If you have connected a remote control to the **CONTROL IN** jack (using a mini-plug cable), you won't be able to control this unit using the remote sensor.

Switching components on and off using the 12 volt trigger

You can connect components in your system (such as a screen or projector) to this receiver so that they switch on or off using 12 volt triggers when you select an input function. However, you must specify which input functions switch on the trigger using the *The Input Setup menu* on page 45. Note that this will only work with components that have a standby mode.

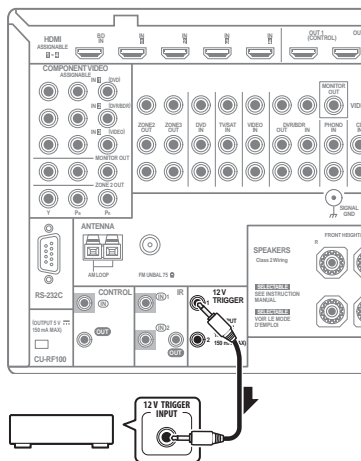

- **Connect the 12 V TRIGGER jack of this receiver to the 12 V trigger of another component.**

Use a cable with a mono mini-plug on each end for the connection.

After you've specified the input functions that will switch on the trigger, you'll be able to switch the component on or off just by pressing the input function(s) you've set on page 45.

It is also possible to have the component switch not when the input function is switched, but when **HDMI OUT** is switched. For details, see *HDMI Setup* on page 73.

Plugging in the receiver

Only plug in after you have connected all your components to this receiver, including the speakers.

- 1 **Plug the supplied power cord into the AC IN socket on the back of the receiver.**
- 2 **Plug the other end into a power outlet.¹**

⚠ CAUTION

- Handle the power cord by the plug part. Do not pull out the plug by tugging the cord, and never touch the power cord when your hands are wet, as this could cause a short circuit or electric shock. Do not place the unit, a piece of furniture, or other object on the power cord or pinch the cord in any other way. Never make a knot in the cord or tie it with other cables. The power cords should be routed so that they are not likely to be stepped on. A damaged power cord can cause a fire or give you an electric shock. Check the power cord once in a while. If you find it damaged, ask your nearest Pioneer authorized independent service company for a replacement.
- Do not use any power cord other than the one supplied with this unit.
- Do not use the supplied power cord for any purpose other than that described below.
- The receiver should be disconnected by removing the mains plug from the wall socket when not in regular use, e.g., when on vacation.
- Make sure the blue **⏻ STANDBY/ON** light has gone out before unplugging.
- If you have connected speakers with a 6 Ω impedance, change the impedance setting before turning on the power.

📌 Note

¹ After this receiver is connected to an AC outlet, a 2 second to 10 second HDMI initialization process begins. You cannot carry out any operations during this process. The **HDMI** indicator in the front panel display blinks during this process, and you can turn on this receiver once it has stopped blinking. When you set the **Control** with HDMI to **OFF**, you can skip this process. For details about the **Control** with HDMI feature, see *Control with HDMI function* on page 72.

Chapter 4: Basic Setup

Important

- The procedure for setting the receiver operation mode differs for the remote controls included with the SC-37 and SC-35. For the SC-37's remote control, set the remote control operation selector switch to **RECEIVER**. For the SC-35's remote control, press the **RECEIVER** button. When "set the remote control to the receiver operation mode" is indicated in these instructions, use the respective procedure described above.

Changing the OSD display language (OSD Language)

The language used on the Graphical User Interface screen can be changed.

- The explanations in these operating instructions are for when English is selected for the GUI screen.

1 Switch on the receiver and your TV.

Make sure that the TV's video input is set to this receiver (for example, if you connected this receiver to the **VIDEO** jacks on your TV, make sure that the **VIDEO** input is now selected).

2 Set the remote control to the receiver operation mode, then press HOME MENU.

A Graphical User Interface (GUI) screen appears on your TV. Use **↑/↓/←/→** and **ENTER** to navigate through the screens and select menu items. Press **RETURN** to exit the current menu.

3 Select 'System Setup' from the Home Menu.

4 Select 'OSD Language' from the System Setup menu.

5 Select the desired language.

6 Select 'OK' to change the language.

The setting is completed and the **System Setup** menu reappears automatically.

Automatically conducting optimum sound tuning (Full Auto MCACC)

The Full Auto MCACC Setup measures the acoustic characteristics of your listening area, taking into account ambient noise, speaker connection and speaker size, and tests for both channel delay and channel level. After you have set up the microphone provided with your system, the receiver uses the information from a series of test tones to optimize the speaker settings and equalization for your particular room.

SC-37 only: By performing the Full Auto MCACC Setup procedure, the frequency-phase characteristics of the connected speakers are also calibrated.

Once the Full Auto MCACC Setup procedure is completed, the Full Band Phase Control function is automatically turned on (page 63).

Important

- Make sure the microphone and speakers are not moved during the Full Auto MCACC Setup.
- Using the Full Auto MCACC Setup will overwrite any existing settings for the MCACC preset you select.
- Before using the Full Auto MCACC Setup, the headphones should be disconnected.

CAUTION

- The test tones used in the Full Auto MCACC Setup are output at high volume.

THX®

- THX is a trademark of THX Ltd., which may be registered in some jurisdictions. All rights reserved.

1 Switch on the receiver and your TV.

Make sure that the TV's video input is set to this receiver.

2 Connect the microphone to the MCACC SETUP MIC jack on the front panel.

- Push down on the lower portion of the front panel door to access the **MCACC SETUP MIC** jack.

Make sure there are no obstacles between the speakers and the microphone.

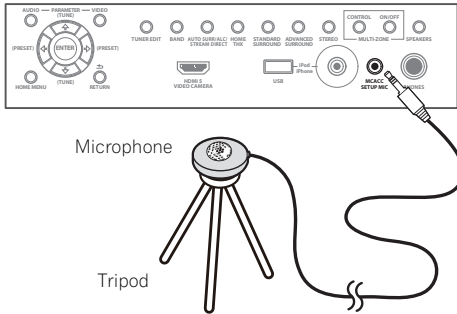

If you have a tripod, use it to place the microphone so that it's about ear level at your normal listening position. If you do not have a tripod, use some other object to install the microphone.¹

The Full Auto MCACC display appears once the microphone is connected.²

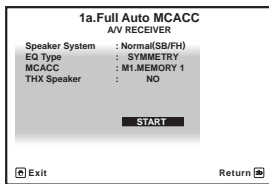

3 Select the parameters you want to set.³

If the speakers are connected using any setup other than **Normal(SB/FH)**, be sure to set **Speaker System** before the Full Auto MCACC Setup. See *Speaker system setting* on page 115.

- **Speaker System**⁴ – Shows the current settings. When this is selected and **ENTER** is pressed, the speaker system selection screen appears. Select the proper speaker system, then press **RETURN** to return.
- **EQ Type** – This determines how the frequency balance is adjusted.

- **MCACC** – The six MCACC presets are used for storing surround sound settings for different listening positions. Simply choose an unused preset for now (you can rename it later in *Data Management* on page 112).
- **THX Speaker** – Select **YES** if you are using THX speakers (set all speakers to **SMALL**), otherwise leave it set to **NO**.

4 Set the remote control to the receiver operation mode, then select START.

5 Follow the instructions on-screen.

Make sure the microphone is connected, and if you're using a subwoofer, make sure it is switched on and set to a comfortable volume level.

6 Wait for the test tones to finish, then confirm the speaker configuration in the GUI screen.

A progress report is displayed on-screen while the receiver outputs test tones to determine the speakers present in your setup. Try to be as quiet as possible while it's doing this.

If no operations are performed for 10 seconds while the speaker configuration check screen is being displayed, the Full Auto MCACC Setup will resume automatically. In this case, you don't need to select '**OK**' and press **ENTER** in step 7.

- With error messages (such as **Too much ambient noise!** or **Check microphone.**), select **RETRY** after checking for ambient noise (see *Problems when using the Auto MCACC Setup* on page 45) and verifying the mic connection. If there doesn't seem to be a problem, you can simply select **GO NEXT** and continue.

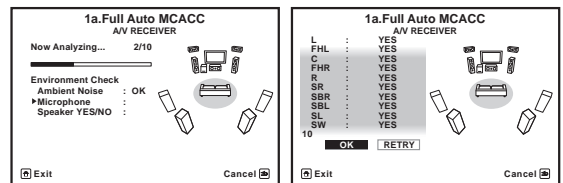

The configuration shown on-screen should reflect the actual speakers you have.

Note

1 Install the microphone on a stable floor. Placing the microphone on any of the following surfaces may make accurate measurement impossible:

- Sofas or other soft surfaces.
- High places such as tabletops and sofa tops.

2 If you leave the GUI screen for over five minutes, the screen saver will appear.

3 When data measurement is taken, the reverb characteristics data (both before- and after-calibration) that this receiver had been storing will be overwritten. If you want to save the reverb characteristics data before measuring, connect a USB memory device to this receiver and transfer the data.

- When measurement is taken of the reverb characteristics data other than **SYMMETRY**, the data are not measured after the correction. If you will need to measure after correcting data, take the measurement using the EQ Professional menu in the Manual MCACC setup (page 106).

4 If you are planning on bi-amping your front speakers, or setting up a separate speaker system in another room, read through *Speaker system setting* on page 115 and make sure to connect your speakers as necessary before continuing to step 4.

- If you see an **ERR** message (or the speaker configuration displayed isn't correct), there may be a problem with the speaker connection. If selecting **RETRY** doesn't work, turn off the power and check the speaker connections. If there doesn't seem to be a problem, you can simply use **↑/↓** to select the speaker and **←/→** to change the setting and continue.
- If **Reverse Phase** is displayed, the speaker's wiring (+ and -) may be inverted. Check the speaker connections.¹
 - If the connections were wrong, turn off the power, disconnect the power cord, then reconnect properly. After this, perform the Full Auto MCACC procedure again.
 - If the connections were right, select **GO NEXT** and continue.

7 Make sure 'OK' is selected, then press ENTER.

A progress report is displayed on-screen while the receiver outputs more test tones to determine the optimum receiver settings.

Again, try to be as quiet as possible while this is happening. It may take 3 to 10 minutes.

8 The Full Auto MCACC Setup procedure is completed and the Home Menu menu reappears automatically.

Be sure to disconnect the microphone from this receiver upon completion of the Full Auto MCACC Setup.

The settings made in the Full Auto MCACC Setup should give you excellent surround sound from your system, but it is also possible to adjust these settings manually using *The Advanced MCACC menu* on page 104 or *The System Setup and Other Setup menus* on page 114.²

Problems when using the Auto MCACC Setup

If the room environment is not optimal for the Auto MCACC Setup (too much background noise, echo off the walls, obstacles blocking the speakers from the microphone) the final settings may be incorrect. Check for household appliances (air conditioner, fridge, fan, etc.), that may be affecting the environment and switch them off if necessary. If there are any instructions showing in the front panel display, please follow them.

- Some older TVs may interfere with the operation of the microphone. If this seems to be happening, switch off the TV when doing the Auto MCACC Setup.

The Input Setup menu

You only need to make settings in the **Input Setup** menu if you didn't hook up your digital equipment according to the default settings (see *Input function default and possible settings* on page 46). In this case, you need to tell the receiver what equipment is hooked up to which terminal so the buttons on the remote control correspond to the components you've connected.

1 Set the remote control to the receiver operation mode, then press HOME MENU.

A Graphical User Interface (GUI) screen appears on your TV. Use **↑/↓/←/→** and **ENTER** to navigate through the screens and select menu items. Press **RETURN** to confirm and exit the current menu.

2 Select 'System Setup' from the Home Menu.

3 Select 'Input Setup' from the System Setup menu.

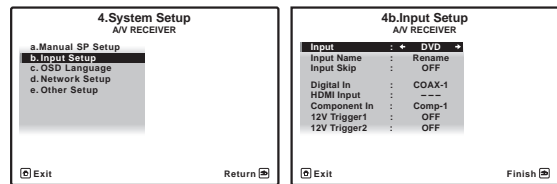

4 Select the input function that you want to set up.

The default names correspond with the names next to the terminals on the rear panel (such as **DVD** or **VIDEO**) which, in turn, correspond with the names on the remote control.

5 Select the input(s) to which you've connected your component.

For example, if your DVD player only has an optical output, you will need to change the **DVD** input function's **Digital In** setting from **COAX-1** (default) to the optical input you've connected it to. The numbering (**OPT-1** to **3**) corresponds with the numbers beside the inputs on the back of the receiver.

6 When you're finished, proceed to the settings for other inputs.

There are optional settings in addition to the assignment of the input jacks:

- **Input Name** – You can choose to rename the input function for easier identification. Select **Rename** to do so, or **Default** to return to the system default.

Note

- 1 If the speaker is not pointed to the microphone (listening position) or when using speakers that affect the phase (dipole speakers, reflective speakers, etc.), **Reverse Phase** may be displayed even if the speakers are properly connected.
- 2 Depending on the characteristics of your room, sometimes identical speakers with cone sizes of around 12 cm (5 inches) will end up with different size settings. You can correct the setting manually using the *Manual speaker setup* on page 114.
 - The subwoofer distance setting may be farther than the actual distance from the listening position. This setting should be accurate (taking delay and room characteristics into account) and generally does not need to be changed.
 - If Full Auto MCACC Setup measurement results are incorrect due to the interaction of the speakers and viewing environment, we recommend adjusting the settings manually.

- **Input Skip** – When set to **ON**, that input is skipped when selecting the input using **INPUT SELECT**. (DVD and other inputs can be still be selected directly with the input function buttons.)
- **12V Trigger1/2** – After connecting a component to one of the 12 volt triggers (see *Switching components on and off using the 12 volt trigger* on page 42), select **MAIN**, **ZONE 2**, **ZONE 3** or **OFF** for the corresponding trigger setting to switch it on automatically along with the (main or sub) zone specified.¹

7 When you're finished, press RETURN.
You will return to the **System Setup** menu.

Input function default and possible settings

The terminals on the receiver generally correspond to the name of one of the input functions. If you have connected components to this receiver differently from (or in addition to) the defaults below, see *The Input Setup menu* on page 45 to tell the receiver how you've connected up. The dots (●) indicate possible assignments.

Input function	Input Terminals		
	Digital	HDMI	Component
DVD	COAX-1	● ^a	IN 1
BD		(BD)	
TV/SAT	OPT-1	● ^a	●
DVR/BDR	OPT-2	● ^a	IN 2
VIDEO	OPT-3	● ^a	IN 3
HDMI 1	●	(HDMI-1)	
HDMI 2		(HDMI-2)	
HDMI 3		(HDMI-3)	
HDMI 4		(HDMI-4)	
HDMI 5 (front panel)		(HDMI-5)	
HOME MEDIA GALLERY ^b			
INTERNET RADIO ^c			
iPod/USB			
XM RADIO			
CD	COAX-2		
CD-R/TAPE	COAX-3 ^d		
TUNER			
ADAPTER PORT			
PHONO			
MULTI CH IN		● ^a	
SIRIUS	●		

a. With **Control** with HDMI set to **ON**, assignments cannot be made (see *Control with HDMI function* on page 72).

b. SC-37 only.

c. SC-35 only.

d. SC-37 only. ● (assignment possible) for the SC-35.

Note

¹ Devices connected to 12 volt triggers can be associated with **HDMI OUT** switching. For details, see *HDMI Setup* on page 73.

Chapter 5: Basic playback

Important

- The procedure for setting the receiver operation mode differs for the remote controls included with the SC-37 and SC-35. For the SC-37's remote control, set the remote control operation selector switch to **RECEIVER**. For the SC-35's remote control, press the **RECEIVER** button. When "set the remote control to the receiver operation mode" is indicated in these instructions, use the respective procedure described above.

Playing a source

Here are the basic instructions for playing a source (such as a DVD disc) with your home theater system.

- 1 Switch on your system components and receiver.**
Make sure that the TV's video input is set to this receiver.
- 2 Set the remote control to the receiver operation mode.**
- 3 Select the input function you want to play.**
You can use the input function buttons on the remote control, **INPUT SELECT**, or the front panel **INPUT SELECTOR** dial.¹
- 4 Press AUTO/ALC/DIRECT (AUTO SURR/ALC/STREAM DIRECT) to select 'AUTO SURROUND' and start playback of the source.**²

If you're playing a Dolby Digital or DTS surround sound source, you should hear surround sound. If you are playing a stereo source, you will only hear sound from the front left/right speakers in the default listening mode.

- See also *Listening to your system* on page 59 for information on different ways of listening to sources.

It is possible to check on the front panel display whether or not multi-channel playback is being performed properly. For details, see *Auto Surround, ALC and Stream Direct with different input signal formats* on page 138.

When using a surround back speaker, **DOD+PLIIX MOVIE** is displayed when playing Dolby Digital signals, and **DTS+Neo:6** is displayed when playing DTS 5.1-channel signals.

Note

- ¹ If you need to manually switch the input signal type press **SIGNAL SEL** (page 62).
- ² You may need to check the digital audio output settings on your DVD player or digital satellite receiver. It should be set to output Dolby Digital, DTS and 88.2 kHz / 96 kHz PCM (2 channel) audio, and if there is an MPEG audio option, set this to convert the MPEG audio to PCM.
- ³ • When playback from the multichannel inputs is selected, only the volume and channel levels can be set.
 - You can't listen to your speaker B system during playback from the multichannel inputs.
 - With **MULTI CH IN** inputs, it is possible to play pictures simultaneously. For details, see *Multi Channel Input Setup* on page 120.

If the display does not correspond to the input signal and listening mode, check the connections and settings.

- 5 Use the volume control to adjust the volume level.**
Turn down the volume of your TV so that all sound is coming from the speakers connected to this receiver.

Playing a source with HDMI connection

- **Set the remote control to the receiver operation mode, then use INPUT SELECT to select the HDMI input you've connected to (for example, HDMI 1).**

You can also perform the same operation by using the **INPUT SELECTOR** dial on the front panel or by pressing **HDMI** on the remote control repeatedly.

- Set the HDMI parameter in *Setting the Audio options* on page 76 to **THROUGH** if you want to hear HDMI audio output from your TV (no sound will be heard from this receiver).
- If the video signal does not appear on your TV, try adjusting the resolution settings on your component or display. Note that some components (such as video game units) have resolutions that may not be converted. In this case, use an analog video connection.

Selecting the multichannel analog inputs

If you have connected a decoder or a DVD player as above, you must select the analog multichannel inputs for surround sound playback.³

- 1 Make sure you have set the playback source to the proper output setting.**

For example, you might need to set your DVD player to output multichannel analog audio.

- 2 Set the remote control to the receiver operation mode, then use INPUT SELECT to select MULTI CH IN.**

You can also use the **INPUT SELECTOR** dial on the front panel.

- Depending on the DVD player you're using, the analog output level of the subwoofer channel may be too low. In this case, the output level of the subwoofer can be increased by 10 dB in the **Multi Ch In Setup** in **Other Setup**. For details, see *Multi Channel Input Setup* on page 120.

Playing an iPod

This receiver has the **iPod/iPhone/USB** terminal that will allow you to control playback of audio content from your iPod using the controls of this receiver.¹

1 Switch on the receiver and your TV.

See *Connecting an iPod* on page 40.

- It is also possible to operate the iPod on the iPod itself, without using the TV screen. For details, see *Switching the iPod controls* on page 49.

2 SC-37 only: Set the remote control operation selector switch to SOURCE.

3 Press iPod USB on the remote control to switch the receiver to the iPod/USB.

Loading appears in the GUI screen while the receiver verifies the connection and retrieves data from the iPod.

When the display shows the **iPod** top menu you're ready to play music from the iPod.²

Playing back audio files stored on an iPod

To navigate songs on your iPod, you can take advantage of the GUI screen of your TV connected to this receiver.³ You can also control all operations for music in the front panel display of this receiver.

Finding what you want to play

When your iPod is connected to this receiver, you can browse songs stored on your iPod by playlist, artist name, album name, song name, genre or composer, similar to using your iPod directly.

1 Use ↑/↓ to select 'Music' from the iPod top menu.

2 Use ↑/↓ to select a category, then press ENTER to browse that category.

- To return to the previous level any time, press **RETURN**.

3 Use ↑/↓ to browse the selected category (e.g., albums).

- Use ←/→ to move to previous/next levels.

4 Continue browsing until you arrive at what you want to play, then press ► to start playback.



Tip

- You can play all of the songs in a particular category by selecting the **All** item at the top of each category list. For example, you can play all the songs by a particular artist.

Basic playback controls

This receiver's remote control buttons can be used for basic playback of files stored on an iPod.⁴

SC-37:

- Set the remote control operation selector switch to **SOURCE**, then press **iPod USB** to switch the remote control to the iPod/USB operation mode.

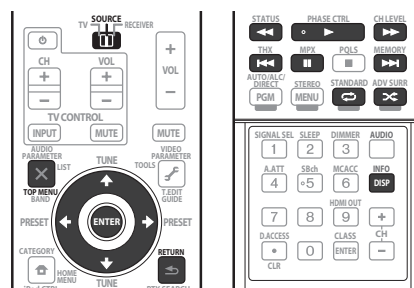

SC-35:

- Press **iPod USB** to switch the remote control to the iPod/USB operation mode.

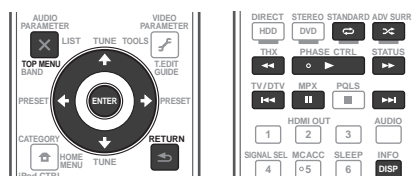

Note

- This system is compatible with the audio and video of the iPod nano, iPod fifth generation (audio only), iPod classic, iPod touch and iPhone. However, some of the functions may be restricted for some models. The system is not compatible with the iPod shuffle.
 - Compatibility may vary depending on the software version of your iPod and iPhone. Please be sure to use the latest available software version.
 - iPod and iPhone are licensed for reproduction of non-copyrighted materials or materials the user is legally permitted to reproduce.
 - Features such as the equalizer cannot be controlled using this receiver, and we recommend switching the equalizer off before connecting.
 - Pioneer cannot under any circumstances accept responsibility for any direct or indirect loss arising from any inconvenience or loss of recorded material resulting from the iPod failure.
 - When listening to a track on the iPod in the main zone, it is possible to control the sub zone, but not to listen to a different track in the sub zone from the one playing in the main zone.
- The controls of your iPod will be inoperable when connected to this receiver.
- Note that characters that cannot be displayed on this receiver are displayed as #.
 - This feature is not available for photos on your iPod. To display photos, switch iPod operation to the iPod (see *Switching the iPod controls* on page 49).
- During Audiobook playback, press ↑/↓ to switch the playback speed: Faster ↔ Normal ↔ Slower

Switching the iPod controls¹

You can switch over the iPod controls between the iPod and the receiver.

1 Press iPod CTRL to switch the iPod controls.

This enables operation and display on your iPod, and this receiver's remote control and GUI screen become inactive.

2 Press iPod CTRL again to switch back to the receiver controls.

Playing a USB device

It is possible to play files² using the USB interface on the front of this receiver.

1 Switch on the receiver and your TV.

See *Connecting a USB device* on page 40.³

2 SC-37 only: Set the remote control operation selector switch to SOURCE.

3 Press iPod USB on the remote control to switch the receiver to the iPod/USB.⁴

Loading appears in the GUI screen as this receiver starts recognizing the USB device connected. When the display shows the **USB Top** menu you're ready to play from the USB device.



Important

If an **Over Current** message lights in the display, the power requirements of the USB device are too high for this receiver. Try following the points below:

- Switch the receiver off, then on again.
- Reconnect the USB device with the receiver switched off.
- Use a dedicated AC adapter (supplied with the device) for USB power.

If this doesn't remedy the problem, it is likely your USB device is incompatible.

Playing back audio files stored on a USB memory device

The maximum number of levels that you can select in Step 2 (below) is 8. Also, you can display and play back up to 30 000 folders and files within a USB memory device.⁵

1 Use ↑/↓ to select 'Music' from the USB Top menu.

2 Use ↑/↓ to select a folder, then press ENTER to browse that folder.

- To return to the previous level any time, press RETURN.

Note

¹ You cannot use this function, when an iPod of fifth generation or iPod nano of first generation is connected.

² • Compatible USB devices include external magnetic hard drives, portable flash memory drives (particularly key drives) and digital audio players (MP3 players) of format FAT16/32.

• Pioneer cannot guarantee compatibility (operation and/or bus power) with all USB mass storage devices and assumes no responsibility for any loss of data that may occur when connected to this receiver.

³ Make sure the receiver is in standby when disconnecting the USB device.

⁴ SC-35 only: The iPod/USB function cannot be selected in the main zone when the Internet radio function is selected in the sub zone. Also, the iPod/USB function cannot be selected in the sub zone when the Internet radio function is selected in the main zone.

⁵ Note that non-Roman characters in the playlist are displayed as #.

3 Continue browsing until you arrive at what you want to play, then press ► to start playback.¹

Basic playback controls

This receiver's remote control buttons can be used for basic playback of files stored on USB memory devices.

SC-37:

- Set the remote control operation selector switch to **SOURCE**, then press **iPod USB** to switch the remote control to the iPod/USB operation mode.

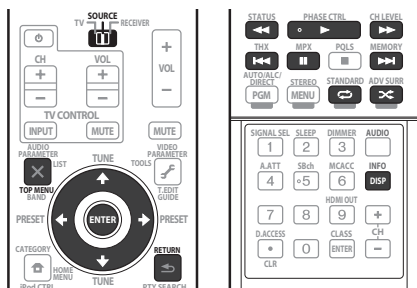

SC-35:

- Press **iPod USB** to switch the remote control to the iPod/USB operation mode.

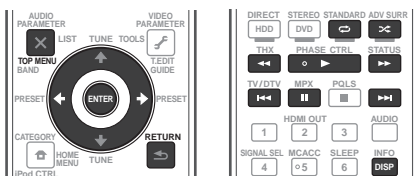

Playing back photo files stored on a USB memory device²

1 Use ↑/↓ to select 'Photos' from the USB Top menu.

2 Use ↑/↓ to select a folder, then press ENTER to browse that folder.

- To return to the previous level any time, press RETURN.

3 Continue browsing until you arrive at what you want to play, then press ► to start playback.³

The selected content is displayed in full screen and a slideshow starts.

After a slideshow launches, pressing ENTER toggles between play and pause (only when **Theme** on the Slideshow Setup is set to **Normal (OFF)**).

Basic playback controls

Button(s)	What it does
ENTER, ►	Starts displaying a photo and playing a slideshow.
RETURN, ←	Stops the player and returns to the previous menu.
◀◀ ^a	Displays the previous photo content.
▶▶ ^a	Displays the next photo content.
^a	Pauses/unpauses the slideshow.
DISP ^a	Displays the photo information.

a. You can only use this button when **Theme** on the Slideshow Setup is set to **Normal (OFF)**

Slideshow Setup

Make the various settings for playing slideshows of photo files here.

1 Use ↑/↓ to select 'Slideshow Setup' from the USB Top menu.

2 Select the setting you want.

- Theme** – Add various effects to the slideshow.
- Interval** – Set the interval for switching the photos. This may not be available depending on the **Theme** setting.
- BGM** – Play music files stored on the USB device while displaying photos.
- Music Select** – Select the folder containing the music files to be played when **BGM** is set to **ON**.

3 When you're finished, press RETURN.

You will return to the **USB Top** menu.

Note

- Copyrighted audio files cannot be played back on this receiver.
 - DRM-protected audio files cannot be played back on this receiver.
- Photo files cannot be played in the sub zone.
- If the slideshow is left in the pause mode for five minutes, the list screen reappears.

About playable file formats

The USB function of this receiver supports the following file formats. Note that some file formats are not available for playback although they are listed as playable file formats.

Music files

Category	Extension	Stream		
MP3^a	.mp3	MPEG-1, 2, 2.5 Audio Layer-3	Sampling frequency	8 kHz to 48 kHz
			Quantization bitrate	16 bit
			Channel	2 ch
			Bitrate	8 kbps to 320 kbps
			VBR/CBR	Supported/Supported
WAV	.wav	LPCM	Sampling frequency	32 kHz, 44.1 kHz, 48 kHz
			Quantization bitrate	8 bit, 16 bit
			Channel	2 ch, Monaural
WMA	.wma	WMA8/g ^b	Sampling frequency	8 kHz to 48 kHz
			Quantization bitrate	16 bit
			Channel	2 ch
			Bitrate	8 kbps to 320 kbps
			VBR/CBR	Supported/Supported

a. "MPEG Layer-3 audio decoding technology licensed from Fraunhofer IIS and Thomson multimedia."

b. Files encoded using Windows Media Codec 9 may be playable but some parts of the specification are not supported; specifically, Pro, Lossless, Voice.

Photo files

Category	Extension		
JPEG	.jpg	Format	Meeting the following conditions:
	.jpeg		
	.jpe	Resolution	30 to 8184 pixels vertical, 40 to 8184 pixels horizontal
	.jif		
	.jfif		

Listening to the radio

The following steps show you how to tune in to FM and AM radio broadcasts using the automatic (search) and manual (step) tuning functions. If you already know the frequency of the station you want, see *Tuning directly to a station* below. Once you are tuned to a station you can memorize the frequency for recall later—see *Saving station presets* below for more on how to do this.

- 1 *SC-37 only*: Set the remote control operation selector switch to **SOURCE**.
- 2 Press **TUNER** to select the tuner.
- 3 Use **BAND** to change the band (FM or AM), if necessary.
- 4 Tune to a station.

There are three ways to do this:

Automatic tuning – To search for stations in the currently selected band, press and hold **TUNE** \uparrow/\downarrow for about a second. The receiver will start searching for the next station, stopping when it has found one. Repeat to search for other stations.

Manual tuning – To change the frequency one step at a time, press **TUNE** \uparrow/\downarrow .

High speed tuning – Press and hold **TUNE** \uparrow/\downarrow for high speed tuning. Release the button at the frequency you want.

Improving FM sound

If the **TUNED** or **STEREO** indicator doesn't light when tuning to an FM station because the signal is weak, press **MPX** to switch the receiver into mono reception mode. This should improve the sound quality and allow you to enjoy the broadcast.

Using the noise cut mode

The two noise cut modes can be used when receiving AM broadcasts. Press **MPX** to select the noise cut mode (1 to 2).

Using Neural Surround

This feature uses Neural Surround™ technologies to achieve optimal surround sound from FM radio.

- While listening to FM radio, press **AUTO/ALC/DIRECT** for Neural Surround.

The **Neural Surround** mode can be selected also with **STANDARD**.

Tuning directly to a station

- 1 *SC-37 only*: Set the remote control operation selector switch to **SOURCE**.
- 2 Press **TUNER** to select the tuner.
- 3 Use **BAND** to change the band (FM or AM), if necessary.
- 4 Press **D.ACCESS** (Direct Access).
- 5 Use the number buttons to enter the frequency of the radio station.

For example, to tune to **106.00** (FM), press **1, 0, 6, 0, 0**.

If you make a mistake halfway through, press **D.ACCESS** twice to cancel the frequency and start over.

Saving station presets

If you often listen to a particular radio station, it's convenient to have the receiver store the frequency for easy recall whenever you want to listen to that station. This saves the effort of manually tuning in each time. This receiver can memorize up to 63 stations, stored in seven banks, or classes (A to G) of 9 stations each.

- 1 Tune to a station you want to memorize. See *Listening to the radio* above for more on this.
- 2 Press **T.EDIT** (TUNER EDIT). The display shows **PRESET MEMORY**, then a blinking memory class.
- 3 Press **CLASS** to select one of the seven classes, then press **PRESET** \leftarrow/\rightarrow to select the station preset you want. You can also use the number buttons to select a station preset.

- 4 Press **ENTER**.

After pressing **ENTER**, the preset class and number stop blinking and the receiver stores the station.

Listening to station presets

- 1 *SC-37 only*: Set the remote control operation selector switch to **SOURCE**.
- 2 Press **TUNER** to select the tuner.
- 3 Press **CLASS** to select the class in which the station is stored. Press repeatedly to cycle through classes A to G.
- 4 Press **PRESET** \leftarrow/\rightarrow to select the station preset you want.
 - You can also use the number buttons on the remote control to recall the station preset.

Naming station presets

For easier identification, you can name your station presets.

1 Choose the station preset you want to name.

See *Listening to station presets* on page 52 for how to do this.

2 Press T.EDIT (TUNER EDIT).

The display shows **PRESET NAME**, then a blinking cursor at the first character position.

3 Input the name you want.

Use **↑/↓** to select a character, **←/→** to set the position, and **ENTER** to confirm your selection.



Tip

- To erase a station name, simply repeat steps 1 to 3 and input eight spaces instead of a name.
- Once you have named a station preset, you can press **DISP** when listening to a station to switch the display between name and frequency.

Listening to Satellite Radio

To listen to Satellite Radio, you'll need to connect either a SIRIUS or XM Satellite Radio tuner (sold separately) to your satellite-ready receiver. Satellite Radio is available to residents of the US (except Alaska and Hawaii) and Canada.

Satellite Radio delivers a variety of commercial-free music from categories ranging from Pop, Rock, Country, R&B, Dance, Jazz, Classical and many more plus coverage of all the top professional and college sports including play by play games from select leagues and teams. Additional programming includes expert sports talk, uncensored entertainment, comedy, family programming, local traffic and weather and news from your most trusted sources.

Whether you purchase a SIRIUS or XM tuner, you'll need to activate and subscribe to begin enjoying the service. Easy to follow installation and setup instructions are provided with the satellite tuners. Whichever service you choose, there are a variety of programming packages available, including the option of adding "The Best of SIRIUS" programming to your XM tuner or "The Best of XM" programming to your SIRIUS tuner, enabling you to enjoy the most popular programming among both services. The "Best of" packages are not available to SIRIUS or XM Canada subscribers at this time.

Family friendly packages are also available to restrict channels featuring content that may be inappropriate for children.

To subscribe to XM, U.S. customers should visit xmradio.com or call 1-800-XMRADIO (1-800-967-2346); Canadian customers should visit xmradio.ca or call XM Listener Care at 1-877-GETXMSR (1-877-438-9677).

To subscribe to SIRIUS, U.S. and Canadian customers can call 1-888-539-SIRI (1-888-539-7474) or visit sirius.com (US) or siriuscanada.ca (Canada).

Listening to XM Radio

For details on XM Radio, see *About SIRIUS and XM* on page 137.

1 SC-37 only: Set the remote control operation selector switch to SOURCE.

2 Press OPTION 2 (SC-37)/XM (SC-35) to switch to the XM RADIO input.

For best reception, you may need to move the XM Mini-Tuner antenna near a window (the southernmost window should produce the best results).

- If after pressing **OPTION 2 (SC-37)/XM (SC-35)** the display shows **Check XM Tuner** or **Check Antenna**, try disconnecting the receiver and tuner connections, and then plugging them back in.¹

After connecting, you will be able to use this receiver to select channels and navigate categories using the GUI screen.²

Selecting channels and browsing by genre

From the XM Channel Guide, you can browse XM Radio channels in the order that they appear, or you can narrow your channel search by genre.³

1 Press ↑/↓ to enter the XM Channel Guide, navigate through the channels one at a time with ↑/↓, then press ENTER to listen to the XM radio broadcast.

- To browse by genre, first press **CATEGORY**, use **↑/↓** to select a genre, then press **ENTER**.
- To cancel and exit any time, press **RETURN**.



Tip

- You can select channels directly by pressing **D.ACCESS**, then the three-digit channel number.
- You can press **DISP** to change XM Radio information in the front panel display.

Note

¹ You can check the strength of reception in *Using the XM Menu* on page 54.

² It's easiest if you have your TV switched on to take advantage of the GUI screens. You can, however, use just the front panel display to do everything if you prefer.

³ Select **0 (RADIO ID)** from the GUI to check the Radio ID of the XM Mini-Tuner.

- The currently selected channel is automatically chosen (without pressing **ENTER**) after five seconds.

Using XM HD Surround

XM HD Surround uses Neural Surround™ technologies to achieve optimal surround sound from XM radio. XM HD Surround Sound is available on select XM channels only.

- **While listening to XM Radio, press AUTO/ALC/DIRECT for XM HD Surround listening.** XM HD Surround can be selected also with **STANDARD**.

Saving channel presets

This receiver can memorize up to 63 channels, stored in seven banks, or classes (A to G) of 9 channels each.¹

1 Select the channel you want to memorize.

See *Selecting channels and browsing by genre* on page 53.

2 Press T.EDIT.

The display shows a blinking memory class.

3 Press CLASS to select one of the seven classes, then press ←/→ to select the channel preset you want.

You can also use the number buttons to select a preset.

- The default for all presets is **XM1**.

4 Press ENTER.

After pressing **ENTER**, the preset class and number stop blinking and the receiver stores the XM channel.



Tip

- You can also press **MEMORY** during reception display to save the information of up to five songs. See *Using the XM Menu* below to recall this information.

Listening to channel presets

1 Press CLASS to select the class in which the channel is stored.

Press repeatedly to cycle through classes A to G.

2 Press ←/→ to select the channel preset you want.

- You can also use the number buttons on the remote control to recall the channel preset.

Note

¹ You can reset the channel presets and memory in *Resetting the system* on page 82.

² You can reset the Channel Skip/Add settings in *Resetting the system* on page 82.

³ In order to activate your radio subscription, you will need the SIRIUS ID (SID) which uniquely identifies your tuner. The SID may be found on a sticker located on the packaging, or on the bottom of the tuner itself. The label will have a printed 12-digit SID number. When you have located the SID, write it down in the space provided near the end of this manual. Contact SIRIUS on the internet at: <https://activate.siriusradio.com>

Follow the prompts to activate your subscription, or you can also call SIRIUS toll-free at 1-888-539-SIRIUS (1-888-539-7474).

• Select **0 (SIRIUS ID)** from the on-screen display to check the Radio ID of the SiriusConnect™ tuner (see *Selecting channels and browsing by genre* on page 55).

⁴ You can check the strength of reception in *Using the SIRIUS Menu* on page 55.

⁵ It's easiest if you have your TV switched on to take advantage of the GUI screens. You can, however, use just the front panel display to do everything if you prefer.

Using the XM Menu

The XM Menu provides additional XM Radio features.²

1 Press TOP MENU.

2 Use ↑/↓ to select a menu item, then press ENTER.

Choose from the following menu items:

- **Channel Skip/Add** – Use ↑/↓ and **ENTER** to select channels you would like to remove/restore from/to the channel guide.
- **Antenna Aiming** – Check the strength of satellite and terrestrial reception.
- **Memory Recall** – Use ↑/↓ to browse your saved song information (see *Tip* above).

3 When you're finished press TOP MENU to return to the reception display.

Listening to SIRIUS Radio

For details on SIRIUS Radio, see *About SIRIUS and XM* on page 137.

1 SC-37 only: Set the remote control operation selector switch to SOURCE.

2 Press OPTION 1 (SC-37)/SIRIUS (SC-35) to switch to the SIRIUS input.

For best reception, you may need to move the SiriusConnect™ tuner antenna near a window (refer to the manual for the SiriusConnect™ Home tuner for antenna placement recommendations).³

- If after pressing **OPTION 1 (SC-37)/SIRIUS (SC-35)** the display shows **Antenna Error**, try disconnecting the antenna and reconnecting.⁴ If the display shows **Check Sirius Tuner**, check the connection of the AC adapter and this receiver to the SiriusConnect™ tuner.

After connecting, you will be able to use this receiver to select channels and navigate categories using the GUI screen display.⁵

Selecting channels and browsing by genre

From the SIRIUS Channel Guide, you can browse SIRIUS Radio channels in the order that they appear, or you can narrow your channel search by genre.

1 Press ↑/↓ to enter the SIRIUS Channel Guide, navigate through the channels one at time with ↑/↓, then press ENTER to listen to the SIRIUS radio broadcast.

- To browse by genre, first press **CATEGORY**, use ↑/↓ to select a genre, then press **ENTER**.
- To cancel and exit any time, press **RETURN**.



Tip

- You can select channels directly by pressing **D.ACCESS**, then the three-digit channel number.
- You can press **DISP** to change SIRIUS Radio information in the front panel display.
- The currently selected channel is automatically chosen (without pressing **ENTER**) after five seconds.

Saving channel presets

This receiver can memorize up to 63 channels, stored in seven banks, or classes (A to G) of nine channels each.¹

1 Select the channel you want to memorize.

See *Selecting channels and browsing by genre* above.

2 Press T.EDIT.

The display shows a blinking memory class.

3 Press CLASS to select one of the seven classes, then press ←/→ to select the channel preset you want.

You can also use the number buttons to select a preset.

4 Press ENTER.

After pressing **ENTER**, the preset class and number stop blinking and the receiver stores the SIRIUS channel.



Tip

- You can also press **MEMORY** during reception display to save the information of up to five songs. See *Using the SIRIUS Menu* below to recall this information.

Listening to channel presets

1 Press CLASS to select the class in which the channel is stored.

Press repeatedly to cycle through classes A to G.

2 Press ←/→ to select the channel preset you want.

- You can also use the number buttons on the remote control to recall the channel preset.

Using the SIRIUS Menu

The SIRIUS Menu provides additional SIRIUS Radio features.²

1 Press TOP MENU.

2 Use ↑/↓ to select a menu item, then press ENTER. Choose from the following menu items:

- **Channel Skip/Add** – Use ↑/↓ and **ENTER** to select channels you would like to remove/restore from/to the channel guide.
- **Parental Lock** – Use ↑/↓ and **ENTER** to select channels you would like to place under parental lock. Channels put under parental lock are not displayed in the Channel Guide, but may be accessed by directly inputting their channel number and providing the parental lock password.
- **Antenna Aiming** – Check the strength of satellite and terrestrial reception.
- **Memory Recall** – Use ↑/↓ to browse your saved song information (see *Tip* above).
- **Password Set** – Set the parental lock password.

3 When you're finished press TOP MENU to return to the reception display.

Note

¹ You can reset the Channel presets and memory in *Resetting the system* on page 82.

² You can reset the Channel Skip/Add, Parental Lock and Password settings in *Resetting the system* on page 82.

Listening to Internet radio stations

(SC-35 only)



Tip

- This section describes how to listen to Internet radio on the SC-35. On the SC-37, Internet radio is operated with Home Media Gallery. For details, see *Playback with HOME MEDIA GALLERY inputs (SC-37 only)* on page 64.

Internet radio is an audio broadcasting service transmitted via the Internet.¹ There are a large number of Internet radio stations broadcasting a variety of services from every corner of the world. Some are hosted, managed, and broadcast by private individuals while others are by the corresponding traditional terrestrial radio stations or radio networks. Whereas terrestrial, or OTA (over-the-air), radio stations are geographically restricted on the range of radio waves broadcast from a transmitter through the air, Internet radio stations are accessible from anywhere in the world, as long as there is a connection to the Internet, as services are not transmitted through the air but are delivered over the World Wide Web. On this receiver you can select Internet radio stations by genre as well as by region.



Important

- Before listening to Internet radio, you need to program the Internet radio stations you wish to listen to onto this unit. See *Programming the Internet radio stations* below for how to program. Though the Internet radio stations are programmed in this receiver before it leaves the factory, the link may have expired. In that case, preset the stations again yourself.

1 Press NET RADIO to switch to the Internet radio input.²

The Internet Radio list screen is displayed.

2 Use ↑/↓ to select the Internet radio station to play back, and then press ENTER.

Press ↑/↓ to scroll up and down the list and select the desired item. When you press **ENTER**, playback starts with the playback screen being displayed for the selected item. Depending on the Internet line conditions, the sound may not be smooth when playing Internet radio.

To return to the list screen, press **RETURN**.³

Programming the Internet radio stations

By programming the Internet radio stations you wish to listen to onto this receiver, you will be able to select those Internet radio stations. You can program up to 24 stations.

There are two methods of programming: one lets you use the GUI screen on this receiver; the other lets you connect your computer and use that screen.

Programming with the GUI screen

1 Press TOP MENU when the Internet Radio station list is displayed.

The Internet Radio Setup screen is displayed.

2 Use ↑/↓ to select the Internet Radio station list screen you wish to edit, and then press ENTER.

3 Use ←/→ to select "Edit".

- If you select "Delete", information regarding the Internet radio stations programmed into the currently selected memory will be deleted.

4 Enter the URL of the Internet radio station you wish to program.⁴

Use ↑/↓ to select a letter and ←/→ to move the cursor.

- A URL containing up to 192 letters can be entered.

5 Enter the title of the Internet radio station.

Use ↑/↓ to select a letter and ←/→ to move the cursor.

- A title containing up to 22 letters can be entered.

Programming on the computer screen

You can enter the Internet radio list on the screen of a computer that is connected to the same LAN as this receiver, and send the list to this unit.

The computer needs to be connected in advance to the network of this receiver and set up.

Note

- 1 To listen to Internet radio stations, you must have high-speed broadband Internet access. With a 56 K or ISDN modem, you may not enjoy the full benefits of Internet radio.
 - The port number varies depending on the Internet radio station. Check the firewall settings.
 - Broadcasts may be stopped or interrupted depending on the Internet radio station. In this case, you cannot listen to a radio station selected from the list of Internet radio stations.
- 2 The Internet radio function cannot be selected in the main zone when the iPod/USB function is selected in the sub zone. Also, the Internet radio function cannot be selected in the sub zone when the iPod/USB function is selected in the main zone.
- 3 When the list screen is displayed from the playback screen, the playback screen reappears automatically if no operation is performed for 10 seconds while the list screen is displayed.
- 4 The URL can also be entered by connecting a USB keyboard (see *Connecting a USB device* on page 40).

1 Turn on the computer and launch the Internet browser.

2 In the address bar on the browser, enter the IP address assigned to this receiver.

For example, if the IP address of this receiver is "192.168.0.2", enter "http://192.168.0.2/".

When the connection is made with the receiver, a Top Menu will be displayed.

- This receiver's IP address can be found in the 'IP address, Proxy' menu (page 117).

3 Select 'Internet Radio Setting'.

The following programming screen will be shown on the browser.

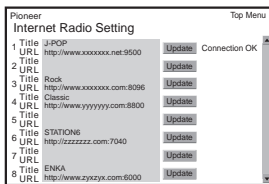

4 Enter the title and URL of the Internet radio station you wish to program, then press 'Update'.

The entered information will be transmitted to the receiver.

The connection to the URL designated from the computer will be confirmed:

If connection is successful, 'Connection OK' will be displayed on screen, and the selected Internet radio station will begin playing via this receiver.

If the connection failed, 'Connection NG' will be displayed. Check to see if the URL you entered is correct.

Important

- 'Connection OK' and 'Connection NG' are only displayed when this receiver is set to the Internet radio function.
- When entering the title and URL of Internet radio station, do not press 'Update' while you are connected to other stations (i.e., labelled as "Connecting...").

Bluetooth ADAPTER for Wireless Enjoyment of Music

Bluetooth wireless technology enabled device: cell phone

Bluetooth wireless technology enabled device: Digital music player

Device not equipped with Bluetooth wireless technology: Digital music player + Bluetooth audio transmitter (sold commercially)

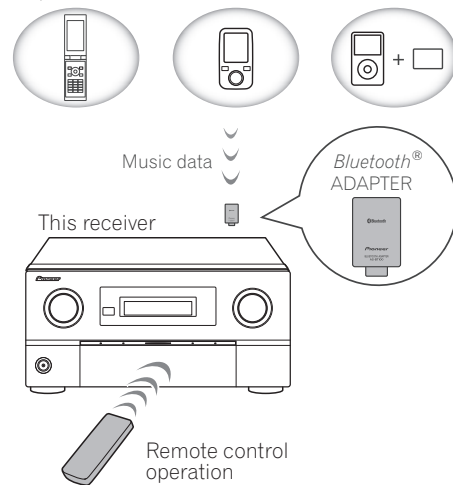

Wireless music play

When the Bluetooth ADAPTER (Pioneer Model No. AS-BT100)¹ is connected to this unit, a product equipped with Bluetooth wireless technology (portable cell phone, digital music player, etc.) can be used to listen to music wirelessly. Also, by using a commercially available transmitter supporting Bluetooth wireless technology, you can listen to music on a device not equipped with Bluetooth wireless technology. The AS-BT100 model supports SCMS-T contents protection, so music can also be enjoyed on devices equipped with SCMS-T type Bluetooth wireless technology.

Remote control operation

The remote control supplied with this unit allows you to play and stop media, and perform other operations.²

Note

- 1 The Bluetooth ADAPTER (AS-BT100) is sold separately.
- 2 • It must be necessary that the Bluetooth wireless technology enabled device supports AVRCP profiles.
 - Remote control operations cannot be guaranteed for all Bluetooth wireless technology enabled devices.

Pairing the *Bluetooth* ADAPTER and *Bluetooth* wireless technology device

"Pairing" must be done before you start playback of *Bluetooth* wireless technology content using the *Bluetooth* ADAPTER. Make sure to perform pairing the first time you operate the system or any time pairing data is cleared. The pairing step is necessary to register the *Bluetooth* wireless technology device to enable *Bluetooth* communications.¹ For more details, see also the operating instructions of your *Bluetooth* wireless technology device.

- 1 Set the remote control to the receiver operation mode, then press HOME MENU.
- 2 Select 'System Setup', then press ENTER.
- 3 Select 'Other Setup', then press ENTER.
- 4 Select 'Pairing Bluetooth Device', then press ENTER.
- 5 Select the 'Passcode' setting you want.

Select the same passcode as the *Bluetooth* wireless technology device you wish to connect.

- **0000/1234/8888** – Select the passcode from these options. These are the passcodes that can be used in most cases.
- **Others** – Select to use a passcode other than those mentioned above.

6 If you selected Others in step 5, enter the passcode.

Use \uparrow/\downarrow to select a number and \leftarrow/\rightarrow to move the cursor.

7 Follow the instructions displayed on the GUI screen to conduct pairing with the *Bluetooth* wireless technology device.

Switch on the *Bluetooth* wireless technology device that you want to make pair, place it near the receiver and set it to the pairing mode.

8 Check to see that the *Bluetooth* ADAPTER is detected by the *Bluetooth* wireless technology device.

When the *Bluetooth* wireless technology device is connected:

CONNECTED appears in the receiver display.²

When the *Bluetooth* wireless technology device is not connected:

Go back to the passcode setting in step 5. In this case, perform the connection operation from the *Bluetooth* wireless technology device.

9 From the *Bluetooth* wireless technology device list, select *Bluetooth* ADAPTER and enter the Passcode selected in step 5.³

Listening to music contents of a *Bluetooth* wireless technology device with your system

- 1 *SC-37* only: Set the remote control operation selector switch to SOURCE.
- 2 Press ADAPTER on the remote control to switch the receiver to ADAPTER PORT input.⁴
- 3 From the *Bluetooth* wireless technology device, perform the operation to connect to the *Bluetooth* ADAPTER.
- 4 Start playback of music contents stored on the *Bluetooth* wireless technology device.

This receiver's remote control buttons can be used for basic playback of files stored on *Bluetooth* wireless technology devices.⁵

SC-37:



SC-35:



The *Bluetooth*® word mark and logos are registered trademarks owned by Bluetooth SIG, Inc. and any use of such marks by Pioneer Corporation is under license. Other trademarks and trade names are those of their respective owners.

Note

- 1 Pairing is required when you first use the *Bluetooth* wireless technology device and *Bluetooth* ADAPTER.
 - To enable *Bluetooth* communication, pairing should be done with both your system and *Bluetooth* wireless technology device.
- 2 The system can display alphanumeric characters only. Other characters may not be displayed correctly.
- 3 The passcode may in some cases be referred to as PASSKEY or PIN code.
- 4 When the *Bluetooth* ADAPTER is not plugged into the **ADAPTER PORT**, **NO ADAPTER** will be displayed if **ADAPTER PORT** input is selected.
- 5 *Bluetooth* wireless technology device should be compatible with AVRCP profile.
 - Depending on the *Bluetooth* wireless technology device you use, operation may differ from what is shown in the remote control buttons.

Chapter 6:

Listening to your system

 Important

- The procedure for setting the receiver operation mode differs for the remote controls included with the SC-37 and SC-35. For the SC-37's remote control, set the remote control operation selector switch to **RECEIVER**. For the SC-35's remote control, press the **RECEIVER** button. When "set the remote control to the receiver operation mode" is indicated in these instructions, use the respective procedure described above.
- The listening modes and many features described in this section may not be available depending on the current source, settings and status of the receiver.

Auto playback

There are many ways to listen back to sources using this receiver, but the simplest, most direct listening option is the Auto Surround feature. The receiver automatically detects what kind of source you're playing and selects multichannel or stereo playback as necessary.

1 Set the remote control to the receiver operation mode.**2 While listening to a source, press AUTO/ALC/DIRECT (AUTO SURR/ALC/STREAM DIRECT) for auto playback of a source.**

AUTO SURROUND shows briefly in the display before showing the decoding or playback format. Check the digital format indicators in the front panel display to see how the source is being processed.

- If the source is Dolby Digital, DTS, or Dolby Surround encoded, the proper decoding format will automatically be selected and shows in the display.
- When listening to the FM radio, the Neural Surround feature is selected automatically (see *Using Neural Surround* on page 52 for more on this).
- When listening to the **ADAPTER PORT** input, the **SOUND RETRIEVER AIR** feature is selected automatically (see *Listening in stereo* on page 61 for more on this).
- When listening to XM Radio, the XM HD Surround feature is selected automatically (see *Using XM HD Surround* on page 54 for more on this).

 Note

1 If the surround back speakers are not connected or **V.SB** is switched **OFF** (page 76), **Pro Logic IIx** becomes **Pro Logic II** (5.1 channel sound).

2 When listening to 2-channel sources in Dolby Pro Logic IIx Music mode, there are three further parameters you can adjust: **C.WIDTH**, **DIMENSION** and **PANORAMA**. See *Setting the Audio options* on page 76 to adjust them.

ALC – In the Auto level control (**ALC**) mode, this receiver equalizes playback sound levels.

OPTIMUM SURR (*SC-37 only*) – In the Optimum Surround mode, this receiver automatically optimizes sound balance in each scene based on actually set volume. The sound balancer controls three major theater sound elements dialogue, bass and surround with original algorithm.

 Tip

- When **ALC** is selected, the effect level can be adjusted using the **EFFECT** parameter in *Setting the Audio options* on page 76.

Listening in surround sound

Using this receiver, you can listen to any source in surround sound. However, the options available will depend on your speaker setup and the type of source you're listening to.

Standard surround sound

The following modes provide basic surround sound for stereo and multichannel sources.

1 Set the remote control to the receiver operation mode.**2 While listening to a source, press STANDARD (STANDARD SURROUND).**

If necessary, press repeatedly to select a listening mode.

- If the source is Dolby Digital, DTS, or Dolby Surround encoded, the proper decoding format will automatically be selected and shows in the display.¹

With two channel sources, you can select from:

- **Pro Logic IIx MOVIE** – Up to 7.1 channel sound (surround back), especially suited to movie sources
- **Pro Logic IIx MUSIC** – Up to 7.1 channel sound (surround back), especially suited to music sources²
- **Pro Logic IIx GAME** – Up to 7.1 channel sound (surround back), especially suited to video games
- **PRO LOGIC** – 4.1 channel surround sound (sound from the surround speakers is mono)

- **Pro Logic IIz HEIGHT** – Up to 7.1 channel sound (front height)¹
- **WIDE SURROUND MOVIE** – Up to 7.1 channel sound (front wide), especially suited to movie sources²
- **WIDE SURROUND MUSIC** – Up to 7.1 channel sound (front wide), especially suited to music sources²
- **Neo:6 CINEMA** – 7.1 channel sound (surround back), especially suited to movie sources³
- **Neo:6 MUSIC** – 7.1 channel sound (surround back), especially suited to music sources³
- **Neural Surround** – Up to 7.1 channel sound (surround back), especially suited to music sources⁴
- **XM HD Surround** – Up to 7.1 channel sound, especially suited to music sources⁵

With multichannel sources, if you have connected surround back, front height or front wide speakers, you can select (according to format):

- **Pro Logic IIx MOVIE** – See above
- **Pro Logic IIx MUSIC** – See above
- **Dolby Digital EX** – Creates surround back channel sound for 5.1 channel sources and provides pure decoding for 6.1 channel sources (like Dolby Digital Surround EX)
- **DTS-ES** – Allows you to hear 6.1 channel playback with DTS-ES encoded sources
- **DTS Neo:6** – Allows you to hear 6.1 channel playback with DTS encoded sources
- **Pro Logic IIz HEIGHT** – See above¹
- **WIDE SURROUND MOVIE** – See above²
- **WIDE SURROUND MUSIC** – See above²
- Straight Decode – Plays back without the effects above.

Using the Home THX modes

THX and Home THX are technical standards created by THX Ltd. for cinema and home theater sound. Home THX is designed to make home theater audio sound more like what you hear in a cinema.

Different THX options will be available depending on the source and the setting for surround back channel processing (see *THX Audio Setting* on page 117 for more on this).

Note

- This mode can only be selected when **Speaker System** is set to **Normal(SB/FH)**.
 - When listening sources in **Pro Logic IIz HEIGHT** mode, you can also adjust the **H.GAIN** effect (see *Setting the Audio options* on page 76).
- This mode can only be selected when **Speaker System** is set to **Normal(SB/FW)**.
- When listening to 2-channel sources in Neo:6 Cinema or Neo:6 Music mode, you can also adjust the center image effect (see *Setting the Audio options* on page 76).
- **Neural Surround** can be selected for 2-channel signals for which the input signal is PCM (48 kHz or less), Dolby Digital, DTS or analog 2-channel sources.
- **XM HD Surround** can be selected only with the XM input.
- **ULTRA2** for the SC-37, **SELECT2** for the SC-35.
 - Unavailable with only one surround back speaker connected or not connected.

1 Set the remote control to the receiver operation mode.

Press **THX (HOME THX)** to select a listening mode. With two channel sources, press **THX** repeatedly to select a matrix-decoding process for the **THX CINEMA** mode (see *THX Audio Setting* on page 117 for an explanation of each process):

- **Pro Logic IIx MOVIE+THX CINEMA**
- **PRO LOGIC+THX CINEMA**
- **Neo:6 CINEMA+THX CINEMA**
- **Pro Logic IIx MUSIC+THX MUSIC**
- **Neo:6 MUSIC+THX MUSIC**
- **Pro Logic IIx GAME+THX GAMES**
- **Pro Logic IIz HEIGHT+THX CINEMA**¹
- **Pro Logic IIz HEIGHT+THX MUSIC**¹
- **Pro Logic IIz HEIGHT+THX GAMES**¹
- **THX ULTRA2/SELECT2 GAMES**⁶

With multichannel sources, press **THX (HOME THX)** repeatedly to select from:

- **THX Surround EX** – Allows you to hear 6.1 or 7.1 channel playback with 5.1 channel sources
- **Neo:6 CINEMA+THX CINEMA**
- **Pro Logic IIx MOVIE+THX CINEMA**
- **THX ULTRA2/SELECT2 CINEMA**⁶ – Allows you to hear 7.1 channel playback with 5.1 channel sources
- **Pro Logic IIx MUSIC+THX MUSIC**
- **Pro Logic IIz HEIGHT+THX CINEMA**¹
- **Pro Logic IIz HEIGHT+THX MUSIC**¹
- **Pro Logic IIz HEIGHT+THX GAMES**¹
- **THX ULTRA2/SELECT2 MUSIC**⁶ – This mode is suited not only for sources recorded in Dolby Digital and DTS, but also to all multi-channel music sources (DVD-Audio, etc.).
- **THX ULTRA2/SELECT2 GAMES**⁶ – This mode is suited to playing the sound of games.

Using the Advanced surround effects

The Advanced surround effects can be used for a variety of additional surround sound effects. Most Advanced Surround modes are designed to be used with film soundtracks, but some modes are also suited for music sources. Try different settings with various soundtracks to see which you like.

1 Set the remote control to the receiver operation mode.

2 Press ADV SURR (ADVANCED SURROUND) repeatedly to select a listening mode.

- **ACTION** – Designed for action movies with dynamic soundtracks
- **DRAMA** – Designed for movies with lots of dialog
- **SCI-FI** – Designed for science fiction with lots of special effects
- **MONO FILM** – Creates surround sound from mono soundtracks
- **ENT.SHOW** – Suitable for musical sources
- **EXPANDED** – Creates an extra wide stereo field
- **TV SURROUND** – Provides surround sound for both mono and stereo TV sources
- **ADVANCED GAME** – Suitable for video games
- **SPORTS** – Suitable for sports programs
- **CLASSICAL** – Gives a large concert hall-type sound
- **ROCK/POP** – Creates a live concert sound for rock and/or pop music
- **UNPLUGGED** – Suitable for acoustic music sources
- **EXT.STEREO** – Gives multichannel sound to a stereo source, using all of your speakers
- **PHONES SURR** – When listening through headphones, you can still get the effect of overall surround.



Tip

- When an Advanced Surround listening mode is selected, the effect level can be adjusted using the **EFFECT** parameter in *Setting the Audio options* on page 76.

Listening in stereo

When you select **STEREO**, you will hear the source through just the front left and right speakers (and possibly your subwoofer depending on your speaker settings). Multichannel sources are downmixed to stereo.

1 Set the remote control to the receiver operation mode.

2 While listening to a source, press STEREO for stereo playback.

Press repeatedly to switch between:

- **STEREO** – The audio is heard with your sound settings and you can still use the audio options.
- **F.S.SURR FOCUS** – See *Using Front Stage Surround Advance* below for more on this.
- **F.S.SURR WIDE** – See *Using Front Stage Surround Advance* below for more on this.
- **SOUND RETRIEVER AIR**¹ – Suitable for listening to the sound from a *Bluetooth* wireless technology device.

Using Front Stage Surround Advance

The Front Stage Surround Advance function allows you to create natural surround sound effects using just the front speakers and the subwoofer.

1 Set the remote control to the receiver operation mode.

2 While listening to a source, press STEREO to select Front Stage Surround Advance modes.

- **STEREO** – See *Listening in stereo* above for more on this.
- **F.S.SURR FOCUS** – Use to provide a rich surround sound effect directed to the center of where the front left and right speakers sound projection area converges.
- **F.S.SURR WIDE** – Use to provide a surround sound effect to a wider area than **FOCUS** mode.

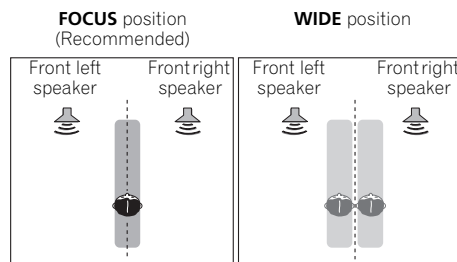

Note

¹ The **SOUND RETRIEVER AIR** listening mode can only be selected when the **ADAPTER PORT** input.

Using Stream Direct

Use the Stream Direct modes when you want to hear the truest possible reproduction of a source. All unnecessary signal processing is bypassed, and you're left with the pure analog or digital sound source. Processing differs depending on the input signal and whether or not surround back speakers are connected. For details, see *Auto Surround, ALC and Stream Direct with different input signal formats* on page 138.

1 Set the remote control to the receiver operation mode.

2 While listening to a source, press AUTO/ALC/DIRECT (AUTO SURR/ALC/STREAM DIRECT) to select the mode you want.

Check the digital format indicators in the front panel display to see how the source is being processed.

- **AUTO SURROUND** – See *Auto playback* on page 59.
- **ALC** – Listening in Auto level control mode (page 59).
- **DIRECT** – Plays back sound from the source with the least modification next to **PURE DIRECT**. With **DIRECT**, the only modifications added to **PURE DIRECT** playback are calibration of the sound field by the MCACC system and the Phase Control effect.
- **PURE DIRECT** – Plays back unmodified sound from source with only minimal digital treatment. No sound is output from the Speaker B in this mode.
- **OPTIMUM SURR (SC-37 only)** – Listening in Optimum Surround mode (page 59).

Selecting MCACC presets

- Default setting: **MEMORY 1**

If you have calibrated your system for different listening positions, you can switch between settings to suit the kind of source you're listening to and where you're sitting (for example, watching movies from a sofa, or playing a video game close to the TV).

1 Set the remote control to the receiver operation mode.

2 While listening to a source, press MCACC.

Press repeatedly to select one of the six MCACC presets¹. See *Data Management* on page 112 to check and manage your current settings.

Choosing the input signal

On this receiver, it is possible to switch the input signals for the different inputs as described below.²

1 Set the remote control to the receiver operation mode.

2 Press SIGNAL SEL to select the input signal corresponding to the source component.

Each press cycles through the options as follows:

- **AUTO** – The receiver selects the first available signal in the following order: **HDMI; DIGITAL; ANALOG**.
- **ANALOG** – Selects an analog signal.
- **DIGITAL** – Selects an optical or coaxial digital signal.
- **HDMI** – Selects an HDMI signal.³
- **PCM** – For PCM input signals.⁴ The receiver selects the first available signal in the following order: **HDMI; DIGITAL**.

When set to **DIGITAL, HDMI** or **AUTO** (only selected **DIGITAL** or **HDMI**), the indicators light according to the signal being decoded (see *Display* on page 16).

Better sound using Phase Control

This receiver's Phase Control feature uses phase correction measures to make sure your sound source arrives at the listening position in phase, preventing unwanted distortion and/or coloring of the sound.

Note

- 1 • These settings have no effect when headphones are connected.
 - You can also press **◀/▶** to select the MCACC preset.
- 2 • This receiver can only play back Dolby Digital, PCM (32 kHz to 192 kHz), DTS (including DTS 96/24) and WMA9 Pro digital signal formats. The compatible signals via the HDMI terminals are: Dolby Digital, DTS, WMA9 Pro, PCM (32 kHz to 192 kHz), Dolby TrueHD, Dolby Digital Plus, DTS-EXPRESS, DTS-HD Master Audio and SACD.
 - You may get digital noise when an LD, CD, DVD or BD player compatible with DTS is playing an analog signal. To prevent noise, make the proper digital connections (page 34) and set the signal input to **DIGITAL**.
 - Some DVD players don't output DTS signals. For more details, refer to the instruction manual supplied with your DVD player.
- 3 • When the **HDMI** audio output parameter is set to **THROUGH**, the sound will be heard through your TV, not from this receiver.
- 4 • This is useful if you find there is a slight delay before **AUTO** recognizes the PCM signal on a CD, for instance.
 - When **PCM** is selected, noise may be output during playback of non-PCM sources. Please select another input signal if this is a problem.

Phase Control technology provides coherent sound reproduction through the use of phase matching¹ for an optimal sound image. The default setting is on and we recommend leaving Phase Control switched on for all sound sources.

1 Set the remote control to the receiver operation mode.

- Press **PHASE CTRL (PHASE CONTROL)** to switch on phase correction.

The **PHASE CONTROL** indicator on the front panel lights.

Better sound using Phase Control and Full Band Phase Control

(SC-37 only)

This receiver is equipped with the two types of functions that correct phase distortion and group delay: Phase Control and Full Band Phase Control. Activating Full Band Phase Control is strongly recommended because it also involves the effects of Phase Control.

The Full Band Phase Control feature calibrates the frequency-phase characteristics of the speakers connected.

Standard speakers designed exclusively for audio use generally reproduce sound with the divided frequency bands output from a speaker system consisting of multiple speakers (in case of typical 3-way speakers, for instance, the tweeter, the squawker (midrange), and the woofer output sound in the high-, middle-, and low-frequency ranges, respectively). Though these speakers are designed to flatten the frequency-amplitude characteristics across wide ranges, there are cases

where the group delay characteristics are not effectively flattened. This phase distortion of the speakers subsequently causes group delay (the delay of low-frequency sound against high-frequency sound) during audio signal playback.

This receiver analyzes the frequency-phase characteristics of the speakers by measuring test signals output from the speakers with the supplied microphone, therefore flattening the analyzed frequency-phase characteristics during audio signal playback² – the same correction is made for a pair of left and right speakers. This correction minimizes group delay between the ranges of a speaker and improves the frequency-phase characteristics across all ranges.

Furthermore, the enhanced frequency-phase characteristics between channels ensure better surround sound integration for multichannel setting.³

1 Set the remote control to the receiver operation mode.

2 Press **PHASE CTRL (PHASE CONTROL)** to select **FULLBAND PHASE**.⁴

Both the Phase Control and Full Band Phase Control functions are switched on. The **FULL BAND** and  indicator, on the front panel lights.

Note

- Phase matching is a very important factor in achieving proper sound reproduction. If two waveforms are 'in phase', they crest and trough together, resulting in increased amplitude, clarity and presence of the sound signal. If a crest of a wave meets a trough, then the sound will be 'out of phase' and an unreliable sound image will be produced.
 - The **PHASE CONTROL** feature is available even when the headphones are plugged in.
 - If your subwoofer has a phase control switch, set it to the plus (+) sign (or 0°). However, the effect you can actually feel when **PHASE CONTROL** is set to **ON** on this receiver depends on the type of your subwoofer. Set your subwoofer to maximize the effect. It is also recommended you try changing the orientation or the place of your subwoofer.
 - Set the built-in lowpass filter switch of your subwoofer to off. If this cannot be done on your subwoofer, set the cutoff frequency to a higher value.
 - If the speaker distance is not properly set, you may not have a maximized **PHASE CONTROL** effect.
 - The **PHASE CONTROL** mode cannot be set to **ON** in the following cases:
 - When the **PURE DIRECT** mode is switched on.
 - When **MULTI CH IN** input is selected.
 - When the **HDMI** audio output parameter is set to **THROUGH** in *Setting the Audio options* on page 76.
- To calibrate and analyze the frequency-phase characteristics of the speakers, either follow the **Full Auto MCACC** procedure under **Advanced MCACC** (see *Automatically conducting optimum sound tuning (Full Auto MCACC)* on page 43), or set **Auto MCACC** menu under **Auto MCACC** under **Advanced MCACC** to **Full Band Phase Ctrl**. Select **ALL** when you perform the **Auto MCACC** with **Auto MCACC** menu. Upon calibration of the frequency-phase characteristics of the speakers, the **Full Band Phase Ctrl** feature is automatically switched on.
- The original characteristics of group delay of the speakers calibrated and the targeted characteristics after correction can be displayed graphically in the GUI screen (see *Group Delay (SC-37 only)* on page 111). Also, by transferring the measurement data to the computer using a USB device, the original characteristics of group delay of the speakers calibrated and the corrected characteristics of group delay can be displayed in 3-dimension on your PC (see *Output MCACC data* on page 112).
- The **Full Band Phase Ctrl** mode cannot be set to **ON** in the following cases:
 - When headphones are plugged in.
 - When the **PURE DIRECT** mode is switched on.
 - When **MULTI CH IN** input is selected.
 - When the **HDMI** audio output parameter is set to **THROUGH** in *Setting the Audio options* on page 76.

Chapter 7:

Playback with HOME MEDIA GALLERY inputs (SC-37 only)



Enjoying the Home Media Gallery

This receiver's Home Media Gallery function allows you to listen to audio files or listen to Internet radio stations on a computer or other component connected to the receiver's LAN terminal. This chapter describes the setup and playback procedures required to enjoy these features. It is advisory that you also refer to the operation manual supplied with your network component.¹

Features of Home Media Gallery

This receiver is equipped with the LAN terminal and you can enjoy the following features by connecting your components to these terminals.

- **Playback the music files stored in PCs²**

You can playback a lot of musics stored in your PCs using this unit.

→ See *Playback with Home Media Gallery* on page 65 and *Playing back audio files stored on components on the network* on page 65.

- **Listening to Internet radio stations**

You can select and listen to your favorite Internet radio station from the list of Internet radio stations created, edited, and managed by the vTuner database service exclusively for use with the Pioneer products.

→ See *Playback with Home Media Gallery* on page 65 and *Listening to Internet radio stations* on page 66.

- **Listening to Rhapsody, Sirius or Neural Music Direct**

→ See *Listening to Rhapsody* on page 66.

→ See *Listening to Sirius Internet Radio* on page 67.

→ See *Listening to Neural Music Direct* on page 67.

Introduction

The Home Media Gallery allows you to play music on media servers connected on an identical Local Area Network (LAN) as the receiver. This unit allows for the playing of files stored on the following:

- PCs running Microsoft Windows Vista or XP with Windows Media Player 11 installed
- PCs running Microsoft Windows 7 with Windows Media Player 12 installed
- DLNA-compatible digital media servers (on PCs or other components)

Files stored in a PC or DMS (Digital Media Server) as described above can be played via command from an external Digital Media Controller (DMC). Devices controlled by this DMC to play files are called DMRs (Digital Media Renderers). This receiver supports this DMR function. When in the DMR mode, such operations as playing and stopping files can be performed from the external controller. Volume adjustment and the muting control are also possible.³ The DMR mode is canceled if the remote control unit is operated while in the DMR mode (aside from certain buttons, including the **VOL +/-**, **MUTE** and **DISP**).

To play back audio files stored on components on the network or listen to Internet radio stations, you must turn on the DHCP server function of your router. In case your router does not have the built-in DHCP server function, it is necessary to set up the network manually. Otherwise, you cannot play back audio files stored on components on the network or listen to Internet radio stations. See *Network Setup menu* on page 117 for more on this.

Authorizing this receiver

In order to be able to play with Home Media Gallery, this receiver must be authorized. This happens automatically when the receiver makes a connection over the network to the PC. If not, please authorize this receiver manually on

Note

- 1 • To listen to Internet radio stations, you must sign a contract with an ISP (Internet Service Provider) beforehand.
 - Photo or video files cannot be played back.
 - With Windows Media Player 11 or Windows Media Player 12, you can even play back copyrighted audio files on this receiver.
- 2 Besides a PC, you can also play back audio files stored on your other components with the built-in media server function based on DLNA 1.0 or DLNA 1.5 framework and protocols (i.e. network-capable hard disks and audio systems).
- 3 Depending on the external controller being used, playback may be interrupted when the volume is adjusted from the controller. In this case, adjust the volume from the receiver or remote control.

the PC. The authorization (or permission) method for access varies depending on the type of server currently being connected. For more information on authorizing this receiver, refer to the instruction manual of your server.

Playback with Home Media Gallery

Important

- When you play back audio files, **'Connecting...'** is displayed before playback starts. The display may continue for several seconds depending on the type of file.
- In case a domain is configured in a Windows network environment, you cannot access a PC on the network while you are logged onto the domain. Instead of logging onto the domain, log onto the local machine.
- There are cases where the time elapsed may not be correctly displayed.

1 Set the remote control operation selector switch to SOURCE.

2 Press HMG to select Home Media Gallery as the input function.

It may take several seconds for this receiver to access the network. The following screen appears when the Home Media Gallery is selected as the input function. The number next to  indicates the number of connected servers.

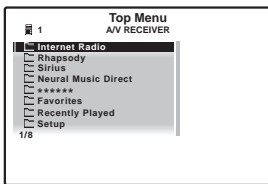

The server without the  mark cannot be accessed.

3 Use ↑/↓ to select the category you want to play back, and then press ENTER.



Select a category from the following list:

- **Internet Radio** – Internet radio
- **Rhapsody** – Rhapsody music broadcast service
- **Sirius** – Internet radio that supports Sirius
- **Neural Music Direct** – Internet radio that supports Neural Surround
- **Server Name** – Server components on the network
- **Favorites** – Favorite songs currently being registered
- **Recently played** – Internet Radio listening history (most recent 20 incidents)

Depending on the selected category, the names of folders, files, and Internet radio stations are displayed.

4 Use ↑/↓ to select the folder, music files or Internet radio station to play back, and then press ENTER.

Press ↑/↓ to scroll up and down the list and select the desired item. When you press **ENTER**, playback starts with the playback screen being displayed for the selected item. To return to the list screen, press **RETURN**.¹

Only audio files with the  mark can be played. In case of the folders with the  mark, use ↑/↓ and **ENTER** to select the desired folder and audio files.

5 Repeat step 4 to play back the desired song.

For detailed operating instructions, refer to the section shown below.

- Internet radio stations – See *Listening to Internet radio stations* on page 66.
- Rhapsody – See *Listening to Rhapsody* on page 66.
- Sirius – See *Listening to Sirius Internet Radio* on page 67.
- Neural Music Direct – See *Listening to Neural Music Direct* on page 67.
- Server – See *Playing back audio files stored on components on the network* below.

Playing back audio files stored on components on the network

You can perform the following operations with the remote control of this receiver. Note that some buttons are not available for operation depending on the category currently being played back.

- Set the remote control operation selector switch to **SOURCE**, then press **HMG** to switch the remote control to the HOME MEDIA GALLERY operation mode.

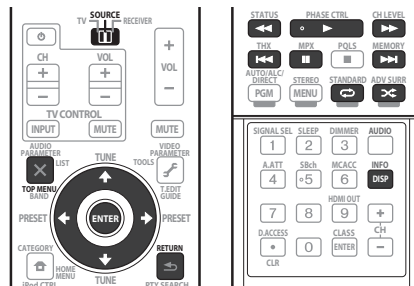

Note

¹ When the list screen is displayed from the playback screen, the playback screen reappears automatically if no operation is performed for 10 seconds while the list screen is displayed.

Listening to Internet radio stations

Internet radio is an audio broadcasting service transmitted via the Internet. There are a large number of Internet radio stations broadcasting a variety of services from every corner of the world. Some are hosted, managed, and broadcast by private individuals while others are by the corresponding traditional terrestrial radio stations or radio networks. Whereas terrestrial, or OTA (over-the-air), radio stations are geographically restricted on the range of radio waves broadcast from a transmitter through the air, Internet radio stations are accessible from anywhere in the world, as long as there is a connection to the Internet, as services are not transmitted through the air but are delivered over the World Wide Web. On this receiver you can select Internet radio stations by genre as well as by region.

Depending on the Internet line conditions, the sound may not be smooth when playing Internet radio.

About list of Internet radio

The list of Internet radio stations on this receiver is created, edited, and managed by the vTuner database service exclusively for use with this receiver. For details about vTuner, see *vTuner* on page 71.

Saving and retrieving Internet radio stations

You can easily save and retrieve saved Internet radio stations. See *Advanced operations for Internet radio* on page 67 for more on this.¹

Registering broadcast stations not on the vTuner list from the special Pioneer site

With the receiver, broadcast stations not included on the list of station distributed by vTuner can be registered and played. Check the access code required for registration on the receiver, use this access code to access the special Pioneer Internet radio site and register the desired broadcast stations in your favorites. The address of the special Pioneer Internet radio site is: <http://www.radio-pioneer.com>

1 Display the Internet Radio list screen.

To display the Internet Radio list screen, perform steps 1 to 3 at *Playback with Home Media Gallery* on page 65.

2 Use **↑/↓** to select 'Help', then press **ENTER**.

3 Use **↑/↓** to select 'Get access code', then press **ENTER**.

The access code required for registration on the special Pioneer Internet radio site is displayed. Make a memo of this address.

The following can be checked on the **Help** screen:

- **Get access code** – The access code required for registration on the special Pioneer Internet radio site is displayed.
- **Show Your WebID/PW** – After registering on the special Pioneer Internet radio site, the registered ID and password are displayed.
- **Reset Your WebID/PW** – Resets all the information registered on the special Pioneer Internet radio site. When reset, all the registered broadcast stations are also cleared. If you want to listen to the same stations, re-register after resetting.

4 **Access the special Pioneer Internet radio site from your computer and perform the registration process.**

<http://www.radio-pioneer.com>

Access the above site and use the access code in step 3 to perform user registration, following the instructions on the screen.

5 **Register the desired broadcast stations as your favorites, following the instructions on the computer's screen.**

Both broadcast stations not on the vTuner list and stations on the vTuner list can be registered. In this case they are registered on the receiver as favorite broadcast stations and can be played.

Listening to Rhapsody

Rhapsody is a paid digital music broadcast service provided by RealNetworks. Rhapsody offers 30-day free trial. Access the website in order to set up a trial account: <http://www.rhapsody.com/pioneer/signup>

- You must have a registered account in order to listen to songs using Rhapsody. For details, see *Checking about the Accounts* on page 68.
- As of April 2010, the Rhapsody service is only offered in the United States.
- Some functions may be changed at Rhapsody's discretion.

Note

- 1 • To listen to Internet radio stations, you must have high-speed broadband Internet access. With a 56 K or ISDN modem, you may not enjoy the full benefits of Internet radio.
 - The port number varies depending on the Internet radio station. Check the firewall settings.
 - A list of Internet radio stations provided by the vTuner database service is subject to change or deletion without notice due to various reasons.
 - Broadcasts may be stopped or interrupted depending on the Internet radio station. In this case, you cannot listen to a radio station selected from the list of Internet radio stations.

Listening to Sirius Internet Radio

Check the website below to listen to Sirius Internet Radio:
<http://www.sirius.com/siriusinternetradio>

- You must have a registered account in order to listen to songs using Sirius Internet Radio. For details, see *Checking about the Accounts* on page 68.
- Some functions may be changed at Sirius's discretion.

Listening to Neural Music Direct

Neural Music Direct is an Internet radio station managed and operated by Neural Audio. Neural radio stations deliver multichannel surround sound. The Neural Surround mode is automatically selected and lets you enjoy a rich multichannel surround sound experience.



Neural Surround is a trademark owned by Neural Audio Corporation.

Playing back your favorite songs

You can register up to 20 of your favorite songs or Internet radio stations in the Favorites folder. Note that only the audio files stored on components on the network can be registered.

Registering and deleting audio files and Internet radio stations in and from the Favorites folder

Press **PGM** while a song is being played back or stopped. The selected song is then registered in the Favorites folder.

Up to 20 songs or Internet radio stations can be registered.

To delete a registered song, select the Favorites folder, select the song you want to delete from the folder, and press **CLR**. The selected song is then deleted from the Favorites folder.

Advanced operations for Internet radio

Saving Internet radio stations

This receiver can remember the Internet radio stations that you often listen to in seven classes (A to G) with up to nine stations in each class to make the total of 63 stations at its maximum capacity.

1 Set the remote control operation selector switch to SOURCE.

2 Tune into the Internet radio station that you want to save.

Tune into the desired Internet radio station by following Steps 2 to 4 on page 65.

3 Press T.EDIT to switch to the station-saving mode.

4 Press CLASS to select the class that you want to save the station in.

Select the desired class from A to G.

5 Use ↑/↓ to select the number that you want to save the station as, and then press ENTER.

You can also select the station number by using the number buttons. Select the desired number from 1 to 9.

Retrieving saved Internet radio stations

You need to save Internet radio stations first before retrieving them. If there are no Internet radio stations currently being saved, see *Saving Internet radio stations* above and save at least one Internet radio station before proceeding with the following steps.

1 Set the remote control operation selector switch to SOURCE.

2 Select the class that you want to retrieve an Internet radio station from.

Each time you press **CLASS**, the class switches to A to G in turn.

3 Use ↑/↓ to select the station number that you want to retrieve.

You can also select the station number by using the number buttons.

'Preset Not Stored' appears when you select an Internet radio station currently not being saved.

Checking about the Accounts

Screen concerning Rhapsody or Sirius Internet Radio account registration.

Before proceeding with the following steps, check whether you have followed Steps from 1 to 2 on page 65.

- 1 **Select 'Setup' then press ENTER.**
- 2 **Select Accounts and press ENTER to confirm your selection.**
- 3 **Select Rhapsody or Sirius and press ENTER.¹**

The contents below can be checked when Rhapsody is selected.

- Sign in to Rhapsody (Set Account)
- Account Info

The contents below can be checked when Sirius is selected.

- Set Account

When disposing of the product, we recommend you reset it to delete the data. See *Resetting the system* on page 82.

About network playback

The network playback function of this unit uses the following technologies:

Windows Media Player

See *Windows Media Player 11/ Windows Media Player 12* on page 71 for more on this.

Windows Media DRM

Microsoft Windows Media Digital Rights Management (WMDRM) is a platform to protect and securely deliver content for playback on computers, portable devices and network devices. Home Media Gallery functions as a WMDRM 10 for networked devices. WMDRM protected content can only be played on media servers supporting WMDRM.

Content owners use WMDRM technology to protect their intellectual property, including copyrights. This device uses WMDRM software to access WMDRM protected content. If the WMDRM software fails to protect the content, content owners may ask Microsoft to revoke the software's ability to use WMDRM to play or copy protected content. Revocation does not affect unprotected content. When you download licenses for protected content, you agree that Microsoft may include a revocation list with the licenses. Content owners may require you to upgrade WMDRM to access their content. If you decline an upgrade, you will not be able to access content that requires the upgrade. This product is protected by certain intellectual property rights of Microsoft. Use or distribution of such technology outside of this product is prohibited without a license from Microsoft.

DLNA



DLNA CERTIFIED™ Audio Player

The Digital Living Network Alliance (DLNA) is a cross-industry organization of consumer electronics, computing industry and mobile device companies. Digital Living provides consumers with easy sharing of digital media through a wired or wireless network in the home.

The DLNA certification logo makes it easy to find products that comply with the DLNA Interoperability Guidelines. This unit complies with DLNA Interoperability Guidelines v1.5.

When a PC running DLNA server software or other DLNA compatible device is connected to this player, some setting changes of software or other devices may be required. Please refer to the operating instructions for the software or device for more information.

DLNA and DLNA CERTIFIED are trademarks and/or service marks of Digital Living Network Alliance.

Content playable over a network

- Even when encoded in a compatible format, some files may not play correctly.
- Movie or Photo files cannot be played back.
- There are cases where you cannot listen to an Internet radio station even if the station can be selected from a list of radio stations.
- Some functions may not be supported depending on the server type or version used.
- Supported file formats vary by server. As such, files not supported by your server are not displayed on this unit. For more information check with the manufacturer of your server.

Note

¹ Some operating procedures, etc., may be changed at the discretion of Rhapsody and Sirius.

About playback behavior over a network

- Playback may stall when the PC is switched off or any media files stored on it are deleted while playing content.
- If there are problems within the network environment (heavy network traffic, etc.) content may not be displayed or played properly (playback may be interrupted or stalled). For best performance, a 100BASE-TX connection between player and PC is recommended.
- If several clients are playing simultaneously, as the case may be, playback is interrupted or stalled.
- Depending on the security software installed on a connected PC and the setting of such software, network connection may be blocked.

Pioneer is not responsible for any malfunction of the player and/or the Home Media Gallery features due to communication error/malfunctions associated with your network connection and/or your PC, or other connected equipment. Please contact your PC manufacturer or Internet service provider.

"Windows Media™" is a trademark of Microsoft Corporation.

This product includes technology owned by Microsoft Corporation and cannot be used or distributed without a license from Microsoft Licensing, Inc.

Microsoft®, Windows®7, Windows®Vista, Windows®XP, Windows®2000, Windows®Millennium Edition, Windows®98, and WindowsNT® are either registered trademarks or trademarks of Microsoft Corporation in the United States and/or other countries.

Software update

The Home Media Gallery software can be updated over the Internet.

- 1 Set the remote control operation selector switch to SOURCE.**
- 2 Press HMG to select Home Media Gallery as the input function.**
- 3 Select 'Setup' then press ENTER.**
- 4 Select 'Firmware Update' then press ENTER.**
- 5 Use ↑/↓ to select 'Yes' then press ENTER.**

Updating % and the elapsed time are displayed.

If **No new firmware has been found** is displayed, there is no need to update the software.

Information on software updates may be posted on the Pioneer website.

<http://www.pioneerelectronics.com>

About playable file formats

The Home Media Gallery feature of this receiver supports the following file formats. Note that some file formats are not available for playback although they are listed as playable file formats. Also, the compatibility of file formats varies depending on the type of server. Check with your server to ensure the compatibility of file formats supported by your server.

Music files

Category	Extension	Stream		
MP3^a	.mp3	MPEG-1 Audio Layer-3	Sampling frequency	8 kHz to 48 kHz
			Quantization bitrate	16 bit
			Channel	2 ch
			Bitrate	8 kbps to 320 kbps
			VBR/CBR	Supported/Supported
LPCM	__b	LPCM	Sampling frequency	8 kHz to 48 kHz
			Quantization bitrate	16 bit, 20 bit, 24 bit
			Channel	2 ch
WAV	.wav	LPCM	Sampling frequency	8 kHz to 48 kHz
			Quantization bitrate	16 bit, 20 bit, 24 bit
			Channel	2 ch
WMA	.wma	WMA2/7/8	Sampling frequency	8 kHz to 48 kHz
			Quantization bitrate	16 bit
			Channel	2 ch
			Bitrate	5 kbps to 320 kbps
			VBR/CBR	Supported/Supported
		WMA9	Sampling frequency	8 kHz to 48 kHz
			Quantization bitrate	16 bit
			Channel	2 ch
			Bitrate	5 kbps to 320 kbps
			VBR/CBR	Supported/Supported
AAC	.m4a .aac .3gp .3g2	MPEG-4 AAC LC MPEG-4 HE AAC (aacPlus v1/2)	Sampling frequency	32 kHz to 48 kHz
			Quantization bitrate	16 bit
			Channel	2 ch
			Bitrate	16 kbps to 320 kbps
			VBR/CBR	Supported/Supported
FLAC	.flac	FLAC	Sampling frequency	8 kHz, 16 kHz, 22 kHz, 32 kHz, 44.1 kHz, 48 kHz
			Quantization bitrate	8 bit, 16 bit
			Channel	2 ch (8-bit monaural audio is not supported)
			Bitrate	—
			VBR/CBR	Not supported/Supported

a. "MPEG Layer-3 audio decoding technology licensed from Fraunhofer IIS and Thomson multimedia."

b. Only streaming data from servers is concerned, so there is no extension.

Glossary

aacPlus

AAC decoder uses aacPlus developed by Coding Technologies. (www.codingtechnologies.com)



FLAC

FLAC (Free Lossless Audio Codec) is an audio format that allows lossless coding. Audio is compressed in FLAC without any loss in quality. For more details about FLAC, visit the following website: <http://flac.sourceforge.net/>

vTuner

vTuner is a paid online database service that allows you to listen to radio and TV broadcasts on the Internet. vTuner lists thousands of stations from over 100 different countries around the globe. For more detail about vTuner, visit the following website: <http://www.radio-pioneer.com>

"This product is protected by certain intellectual property rights of NEMS and BridgeCo. Use or distribution of such technology outside of this product is prohibited without a license from NEMS and BridgeCo or an authorized subsidiary."

Windows Media

Windows Media is a multimedia framework for media creation and distribution for Microsoft Windows. Windows Media is either a registered trademark or trademark of Microsoft Corporation in the U.S. and/or other countries. Use an application licensed by Microsoft Corporation to author, distribute, or play Windows Media formatted content. Using an application unauthorized by Microsoft Corporation is subject to malfunction.

Windows Media DRM

Windows Media DRM is a DRM (Digital Rights Management) service for the Windows Media platform. It is designed to provide secure delivery of audio and/or video content over an IP network to a PC or other playback device in such a way that the distributor can control how that content is used. The WMDRM-protected content can only be played back on a component supporting the WMDRM service.

Windows Media Player 11/ Windows Media Player 12

Windows Media Player is software to deliver music, photos and movies from a Microsoft Windows computer to home stereo systems and TVs.

With this software, you can play back files stored on the PC through various devices wherever you like in your home.

This software can be downloaded from Microsoft's website.

- Windows Media Player 11 (for Windows XP or Windows Vista)
- Windows Media Player 12 (for Windows 7)

For more information check the official Microsoft website.

Chapter 8:

Control with HDMI function

 **Important**

- The procedure for setting the receiver operation mode differs for the remote controls included with the SC-37 and SC-35. For the SC-37's remote control, set the remote control operation selector switch to **RECEIVER**. For the SC-35's remote control, press the **RECEIVER** button. When "set the remote control to the receiver operation mode" is indicated in these instructions, use the respective procedure described above.

Synchronized operations below with a **Control** with HDMI-compatible Pioneer TV or Blu-ray disc player or with a component of another make that supports the **Control** with HDMI functions are possible when the component is connected to the receiver using an HDMI cable.

- The receiver's volume can be set and the sound can be muted using the TV's remote control.
- The receiver's input switches over automatically when the TV's channel is changed or a **Control** with HDMI-compatible component is played.
- The receiver's power is also set to standby, when the TV's power is set to standby.

 **Important**

- With Pioneer devices, the **Control** with HDMI functions are referred to as "KURO LINK".
- You cannot use this function with components that do not support **Control** with HDMI.
- We do not guarantee this receiver will work with Pioneer **Control** with HDMI-compatible components or components of other makes that support the **Control** with HDMI function. We do not guarantee that all synchronized operations will work with components of other makes that support the **Control** with HDMI function.
- Use a High Speed HDMI® cable when you want to use the **Control** with HDMI function. The **Control** with HDMI function may not work properly if a different type of HDMI cable is used.
- For details about concrete operations, settings, etc., refer to also the operating instructions for each component.

Making Control with HDMI connections

You can use synchronized operation for a connected TV and up to five other components.

- Be sure to connect the TV's audio cable to the audio input of this unit. When the TV and receiver are connected by HDMI connections, if the TV supports the HDMI Audio Return Channel function, the sound of the TV is input to the receiver via the HDMI terminal, so there is no need to connect an audio cable. In this case, set **TV Audio** at **HDMI Setup** to **via HDMI** (see *HDMI Setup* on page 73).

For details, see *Connecting your TV and playback components* on page 29.

 **Important**

- When connecting this system or changing connections, be sure to switch the power off and disconnect the power cord from the wall socket. After completing all connections, connect the power cords to the wall socket.
- After this receiver is connected to an AC outlet, a 2 second to 10 second HDMI initialization process begins. You cannot carry out any operations during initialization. The HDMI indicator on the display unit blinks during initialization, and you can turn this receiver on once it has stopped blinking.
- To get the most out of this function, we recommend that you connect your HDMI component not to a TV but rather directly to the HDMI terminal on this receiver.
- While the receiver is equipped with six HDMI inputs (BD, HDMI 1 to 5), the **Control** with HDMI function can only be used with up to three DVD or Blu-ray disc players or up to three DVD or Blu-ray disc recorders.
- The **Control** with HDMI function can be used with a TV connected to the **HDMI OUT 1** terminal, but not with a TV connected to the **HDMI OUT 2** terminal.

HDMI Setup

You must adjust the settings of this receiver as well as the connected **Control** with HDMI-compatible components in order to make use of the **Control** with HDMI function. For more information see the operating instructions for each component.

1 Set the remote control to the receiver operation mode, then press HOME MENU.

2 Select 'System Setup', then press ENTER.

3 Select 'Other Setup', then press ENTER.

4 Select 'HDMI Setup', then press ENTER.

5 Select the 'Control' setting you want.

Choose whether to set this unit's **Control** with HDMI function **ON** or **OFF**. You will need to set it to **ON** to use the **Control** with HDMI function.

When using a component that does not support the **Control** with HDMI function, set this to **OFF**.

- **ON** – Enables the **Control** with HDMI function. When this unit's power is turned off and you have a supported source begin playback while using the **Control** with HDMI function, the audio and video outputs from the HDMI connection are output from the TV.
- **OFF** – The **Control** with HDMI is disabled. Synchronized operations cannot be used. When this unit's power is turned off, audio and video of sources connected via HDMI are not output.

6 Select the 'Control Mode' setting you want.

Choose whether you want to enable HDMI for all linked functions or the PQLS function only. However, Display Power Off will activate the settings set forth in step 7 below.

- **ALL** – Enabled for all linked functions.
- **PQLS** – Enabled only for the PQLS function. When **PQLS** is selected, link functions other than the PQLS function may not work properly. If you wish to use all link functions, select **ALL**.

7 Select the 'Display Power Off' setting you want.

If the TV's power is turned off while using the **Control** with HDMI function, the receiver's power is also turned off (all power off function). This function can be disabled.

- **YES** – The all power off function is enabled. The receiver's power turns off together with the TV's power. This function only works when the input for a component connected to the receiver by HDMI connection is selected or when watching the TV.
- **NO** – The all power off function is disabled. The receiver's power is not affected when the TV's power is turned off.

8 Select the 'Standby Through' setting you want.

It is possible to transfer signals from an HDMI-connected player to the TV when this receiver's power is on standby as long as **Control** is **ON**, but the amount of energy consumed rises. It is, however, possible to minimize energy consumption when power is set to standby.

- **Normal** – Regular setting. Power-up time from standby is short.
- **Eco** – Conserves energy while standby. Power-up time is longer than when set to **Normal**.

9 Select the 'TV Audio' setting you want.

When a TV supporting the HDMI Audio Return Channel function is connected to the receiver, the sound of the TV can be input via the HDMI terminal.

- **Normal** – The TV's sound is input from the Audio input terminals other than HDMI inputs.
- **via HDMI** – The TV's sound is input via the HDMI terminal. This can only be selected when **Control** is set to **ON**.

10 Select the '12V Trigger' setting you want.

The component connected to the **12V TRIGGER** jack can be turned on and off when **HDMI OUT** is switched. **HDMI OUT 1**, **HDMI OUT 2** or **OFF** can be selected. Select **OFF** when you want the component to switch when the input function is switched.

11 When you're finished, press HOME MENU.

Before using synchronization

Once you have finished all connections and settings, you must:

1 Put all components into standby mode.

2 Turn the power on for all components, with the power for the TV being turned on last.

3 Choose the HDMI input to which the TV is connected to this receiver, and see if video output from connected components displays properly on the screen or not.

4 Check whether the components connected to all HDMI inputs are properly displayed.

About synchronized operations

The **Control** with HDMI-compatible component connected to the receiver operates in sync as described below.

- From the menu screen of the **Control** with HDMI-compatible TV, set audio to be played through this receiver, and the receiver will switch to the synchronized amp mode.
- When in the synchronized amp mode, you can adjust the receiver's volume or mute the sound using the TV's remote control.
- When in the synchronized amp mode, the synchronized amp mode is canceled when the receiver's power is turned off. To turn the synchronized amp mode back on, set audio to be played through the receiver from the TV's menu screen, etc. This receiver will power up and switch to the synchronized amp mode.
- When the synchronized amp mode is canceled, the receiver's power turns off if you were viewing an HDMI input or a TV program on the TV.
- When in the synchronized amp mode, the synchronized amp mode is canceled if an operation that produces sound from the TV is performed from the TV's menu screen, etc.
- When the TV's power is set to standby, the receiver's power is also set to standby. (Only when the input for a component connected to the receiver by HDMI connection is selected or when watching the TV.)
- The receiver's input switches automatically when the **Control** with HDMI-compatible component is played.
- The receiver's input switches automatically when the TV's channel is switched.
- The synchronized amp mode remains in effect even if the receiver's input is switched to a component other than one connected by HDMI.

The operations below can also be used on Pioneer **Control** with HDMI-compatible TVs.

- When the receiver's volume is adjusted or the sound is muted, the volume status is displayed on the TV's screen.
- When the OSD language is switched on the TV, the receiver's language setting also switches accordingly.

About connections with a product of a different brand that supports the Control with HDMI function

The synchronized operations below can be used when the receiver's **Control** with HDMI function is connected to a TV of a brand other than Pioneer that supports the **Control** with HDMI function. (Depending on the TV, however, some of the **Control** with HDMI functions may not work.)

- When the TV's power is set to standby, the receiver's power is also set to standby. (Only when the input for a component connected to the receiver by HDMI connection is selected or when watching the TV)
- The sound of TV programs or an external input connected to the TV can also be output from the speakers connected to the receiver. (If the TV does not support the HDMI Audio Return Channel function, this requires connection of an optical digital cable, etc., in addition to the HDMI cable.)

The synchronized operations below can be used when the receiver's **Control** with HDMI function is connected to a player or recorder of a brand other than Pioneer that supports the **Control** with HDMI function.

- When playback starts on the player or recorder, the receiver's input switches to the HDMI input to which that component is connected.

See the Pioneer website for the latest information on the models of non-Pioneer brands and products that support the **Control** with HDMI function.

Setting the PQLS function

PQLS (Precision Quartz Lock System) is a digital audio signal transfer control technology using the **Control** with HDMI function. It offers higher-quality audio playback by controlling audio signals from the receiver to a PQLS compatible player, etc. This enables removing jitter that has a negative effect on the quality of the sound and is generated upon transmission.

- *SC-37 only*: On players compatible with PQLS Bitstream, PQLS always works for all sources.
- On players compatible with PQLS Multi Surround, PQLS works for all sources. Set the player's audio output to Linear PCM.
- On players compatible with PQLS 2 ch Audio, PQLS only works when playing CDs.

Please refer to the operating instructions supplied with your player for more information.

This function is activated when **Control** is set to **ON**.¹

- **Set the remote control to the receiver operation mode, then press PQLS to select the PQLS setting.**

The setting is displayed on the front panel display.

- **PQLS AUTO** – PQLS is enabled. A precision quartz controller in this receiver eliminates distortion caused by timing errors (jitter), giving you the best possible digital-to-analog conversion when you use the HDMI interface. This is valid as an HDMI function for PQLS-compatible players.
- **PQLS OFF** – PQLS is disabled.

Cautions on the Control with HDMI function

- Connect the TV directly to this receiver. Interrupting a direct connection with other amps or an AV converter (such as an HDMI switch) can cause operational errors.
- Only connect components (Blu-ray disc player, etc.) you intend to use as a source to the HDMI input of this receiver. Interrupting a direct connection with other amps or an AV converter (such as an HDMI switch) can cause operational errors.
- When **Control** is set to **ON**, HDMI Input in *The Input Setup menu* on page 45 is automatically set to **OFF**.
- When the receiver's **Control** is turned **ON**, even if the receiver's power is in the standby mode, it is possible to output the audio and video signals from a player via HDMI to the TV without producing sound from the receiver, but only when a **Control** with HDMI-compatible component (Blu-ray disc player, etc.) and compatible TV are connected. In this case, the receiver's power turns on and the power and **HDMI** indicators light.

Note

- If a listening mode other than **AUTO SURROUND**, **ALC**, **DIRECT**, **PURE DIRECT**, **OPTIMUM SURR** (*SC-37 only*) or **STEREO** is selected while the PQLS effect is enabled, the PQLS effect is disabled.
- When this receiver is connected by HDMI cable to a Pioneer player that is compatible with the PQLS function via HDMI connection and HDMI reauthentication is performed (the **HDMI** indicator blinks), the PQLS effect is enabled and the listening mode is set to **AUTO SURROUND** if a listening mode other than **AUTO SURROUND**, **ALC**, **DIRECT**, **PURE DIRECT**, **OPTIMUM SURR** (*SC-37 only*) or **STEREO** is selected.

Chapter 9: Using other functions

Important

- The procedure for setting the receiver operation mode differs for the remote controls included with the SC-37 and SC-35. For the SC-37's remote control, set the remote control operation selector switch to **RECEIVER**. For the SC-35's remote control, press the **RECEIVER** button. When "set the remote control to the receiver operation mode" is indicated in these instructions, use the respective procedure described above.

Setting the Audio options

There are a number of additional sound settings you can make using the **AUDIO PARAMETER** menu. The defaults, if not stated, are listed in bold.

Important

- Note that if a setting doesn't appear in the **AUDIO PARAMETER** menu, it is unavailable due to the current source, settings and status of the receiver.

1 Set the remote control to the receiver operation mode, then press AUDIO PARAMETER.

2 Use ↑/↓ to select the setting you want to adjust. Depending on the current status/mode of the receiver, certain options may not be able to be selected. Check the table below for notes on this.

3 Use ←/→ to set as necessary. See the table below for the options available for each setting.

4 Press RETURN to confirm and exit the menu.

Setting	What it does	Option(s)
MCACC (MCACC preset)	Selects your favorite MCACC preset memory when multiple preset memories are saved. When an MCACC preset memory has been renamed, the given name is displayed.	<i>M1. MEMORY 1</i> to <i>M6. MEMORY 6</i> Default: M1. MEMORY 1
EQ (Acoustic Calibration EQ)	Switches on/off the effects of EQ Pro.	ON <i>OFF</i>
S-WAVE (Standing Wave Control)	Switches on/off the effects of Standing Wave Control.	ON <i>OFF</i>

Setting	What it does	Option(s)
DELAY (Sound Delay)	Some monitors have a slight delay when showing video, so the soundtrack will be slightly out of sync with the picture. By adding a bit of delay, you can adjust the sound to match the presentation of the video.	0.0 to 10.0 (frames) <i>1 second = 30 frames (NTSC)</i> Default: 0.0
MIDNIGHT	Allows you to hear effective surround sound of movies at low volumes.	MIDNIGHT/LOUDNESS OFF <i>MIDNIGHT ON</i>
LOUDNESS	Used to get good bass and treble from music sources at low volumes.	<i>LOUDNESS ON</i>
TONE (Tone Control)	Applies the treble and bass tone controls to a source, or bypasses them completely.	BYPASS <i>ON</i>
BASS ^a	Adjusts the amount of bass.	-6 to +6 (dB) Default: 0 (dB)
TREBLE ^a	Adjusts the amount of treble.	-6 to +6 (dB) Default: 0 (dB)
S.RTRV (Sound Retriever)	With the Sound Retriever function, DSP processing is used to compensate for the loss of audio data upon compression, improving the sound's sense of density and modulation.	OFF ^b <i>ON</i>
DNR (Digital Noise Reduction)	May improve the quality of sound in a noisy source (for example, video tape with lots of background noise) when switched on.	OFF <i>ON</i>
DIALOG E (Dialog Enhance ment)	Localizes dialog in the center channel to make it stand out from other background sounds in a TV or movie soundtrack. By moving from UP1 through UP2 and UP3 up to UP4, you can make the sound source seem to relocate upwards.	OFF <i>FLAT</i> <i>UP1/UP2/UP3/UP4</i> ^c
Hi-bit32 (Hi-bit32/High-Sampling)	Creates a wider dynamic range with digital sources like CDs, DVDs or BDs. Smoother, more delicate musical expression can be achieved by requantizing 16 bit PCM or 20 bit compressed audio signals or 24 bit compressed/lossless audio signals to 32 bit.	OFF <i>ON</i>
Hi-bit (SC-35 only) (High Bit/High Sampling)	Creates a wider dynamic range with digital sources like CDs or DVDs. Smoother, more delicate musical expression can be achieved by requantizing 16 bit PCM or 20 bit compressed audio signals to 24 bit.	OFF <i>ON</i>

Setting	What it does	Option(s)
DUAL (Dual Mono)	Specifies how dual mono encoded Dolby Digital soundtracks should be played. Dual mono is not widely used, but is sometimes necessary when two languages need to be sent to separate channels.	CH1 – Channel 1 is heard only CH2 – Channel 2 is heard only CH1 CH2 – Both channels heard from front speakers
DRC (Dynamic Range Control)	Adjusts the level of dynamic range for movie soundtracks optimized for Dolby Digital, DTS, Dolby Digital Plus, Dolby TrueHD, DTS-HD and DTS-HD Master Audio (you may need to use this feature when listening to surround sound at low volumes).	AUTO ^d <i>MAX</i> <i>MID</i> <i>OFF</i>
LFE (LFE Attenuate)	Some audio sources include ultra-low bass tones. Set the LFE attenuator as necessary to prevent the ultra-low bass tones from distorting the sound from the speakers. The LFE is not limited when set to 0 dB, which is the recommended value. When set to –5 dB, –10 dB, –15 dB or –20 dB, the LFE is limited by the respective degree. When OFF is selected, no sound is output from the LFE channel.	0dB /–5dB/ –10dB/–15dB/ –20dB <i>OFF</i>
SACD GAIN ^e	Brings out detail in SACDs by maximizing the dynamic range (during digital processing).	0dB +6 dB
HDMI ^f (HDMI Audio)	Specifies the routing of the HDMI audio signal out of this receiver (<i>amp</i>) or <i>through</i> to a TV. When THROUGH is selected, no sound is output from this receiver.	AMP <i>THROUGH</i>
A. DELAY (Auto delay)	This feature automatically corrects the audio-to-video delay between components connected with an HDMI cable. The audio delay time is set depending on the operational status of the display connected with an HDMI cable. The video delay time is automatically adjusted according to the audio delay time. ^g	OFF <i>ON</i>
C. WIDTH ^h (Center Width) (Applicable only when using a center speaker)	Provides a better blend of the front speakers by spreading the center channel between the front right and left speakers, making it sound wider (higher settings) or narrower (lower settings).	0 to 7 Default: 3

Setting	What it does	Option(s)
DIMENSION ^h	Adjusts the depth of the surround sound balance from front to back, making the sound more distant (minus settings), or more forward (positive settings).	–3 to +3 Default: 0
PANORAMA ^h	Extends the front stereo image to include the surround speakers for a 'wraparound' effect.	OFF <i>ON</i>
C. IMAGE ⁱ (Center Image) (Applicable only when using a center speaker)	Adjusts the center image to create a wider stereo effect with vocals. Adjust the effect from 0 (all center channel sent to front right and left speakers) to 10 (center channel sent to the center speaker only).	0 to 10 Defaults: Neo:6 MUSIC: 3 Neo:6 CINEMA: 10
EFFECT	Sets the effect level for the currently selected Advanced Surround or ALC mode (each mode can be set separately).	10 to 90 Defaults: EXT.STEREO: 90 Others: 50
H.GAIN (Height Gain)	Adjusts the output from the front height speaker when listening in DOLBY PLIIz HEIGHT mode. If set to HIGH , the sound from the top will be more emphasized.	<i>LOW</i> MID <i>HIGH</i>
V.SB (Virtual Surround Back)	When you're not using surround back speakers, selecting this mode allows you to hear a virtual surround back channel through your surround speakers. You can choose to listen to sources with no surround back channel information, or if the material sounds better in the format (for example, 5.1) for which it was originally encoded, you can have the receiver only apply this effect to 6.1 encoded sources like Dolby Digital EX or DTS-ES. ^j	OFF <i>ON</i>
V.HEIGHT (Virtual Front Height)	When you're not using front height speakers, selecting this mode allows you to hear a virtual front height channel through your front speakers. ^k	OFF <i>ON</i>

- a. The adjustment can be made only when **TONE** is set to **ON**.
- b. With the **iPod/USB, HOME MEDIA GALLERY** (SC-37 only), **INTERNET RADIO** (SC-35 only) or **ADAPTER PORT** input function, by default **S.RTRV** is set to **ON**.
- c. UP1 to UP4 can be selected only when the front height speaker is connected. The presence or absence of effects depends on the listening mode.
- d. The initially set **AUTO** is only available for Dolby TrueHD signals. Select **MAX** or **MID** for signals other than Dolby TrueHD.
- e. You shouldn't have any problems using this with most SACD discs, but if the sound distorts, it is best to switch the gain setting back to **0** dB.

- f. • The HDMI Audio setting cannot be switched while performing synchronized amp mode operations.
- The synchronized amp mode must be turned on in order to play the receiver's HDMI audio and video input signals from the TV with the receiver's power in the standby mode. See *About synchronized operations* on page 74.
- g. This feature is only available when the connected display supports the automatic audio/video synchronizing capability ('lipsync') for HDMI. If you find the automatically set delay time unsuitable, set **A. DELAY** to **OFF** and adjust the delay time manually. For more details about the lipsync feature of your display, contact the manufacturer directly.
- h. Only when listening to 2-channel sources in Dolby Pro Logic IIx Music/Dolby Pro Logic II Music mode.
- i. Only when listening to 2-channel sources in Neo:6 MUSIC/CINEMA mode.
- j. • You can't use the Virtual Surround Back mode when the headphones are connected to this receiver or when any of the stereo, Front Stage Surround Advance, Sound Retriever Air or Stream Direct modes is selected.
- You can only use the Virtual Surround Back mode if the surround speakers are on and the **SB** setting is set to **NO** or if **Front Bi-Amp** or **ZONE 2** is selected at Speaker System. It can also be used when **Speaker B** is selected at Speaker system and **SP▶AB** is selected with the **SPEAKERS** button.
 - When inputting Dolby True HD (SC-35 only), DTS-HD or DTS Express audio signals, the Virtual Surround Back mode cannot be used if no surround signals are recorded in the source.
- k. • You can't use the Virtual Front Height mode when the headphones are connected to this receiver or when any of the stereo, Front Stage Surround Advance, Sound Retriever Air or Stream Direct modes is selected.
- The Virtual Front Height mode cannot be used when no surround speaker is connected.
 - When inputting Dolby True HD (SC-35 only), DTS-HD or DTS Express audio signals, the Virtual Front Height mode cannot be used if no surround signals are recorded in the source.

Setting the Video options

There are a number of additional picture settings you can make using the **VIDEO PARAMETER** menu. The defaults, if not stated, are listed in bold.



Important

- Note that if an option cannot be selected on the **VIDEO PARAMETER** menu, it is unavailable due to the current source, setting and status of the receiver.
- All of the setting items can be set for each input function.
- Setting items other than **V. CONV** can only be selected when **V. CONV** is set to **ON**.

1 Set the remote control to the receiver operation mode, then press VIDEO PARAMETER.

2 Use ↑/↓ to select the setting you want to adjust.

Depending on the current status/mode of the receiver, certain options may not be able to be selected. Check the table below for notes on this.

3 Use ←/→ to set as necessary.

See the table below for the options available for each setting.

4 Press RETURN to confirm and exit the menu.

Setting	What it does	Option(s)
V. CONV ^a (Digital Video Conversion)	Converts video signals for output from the MONITOR OUT jacks (including HDMI OUT connector) for all video types (see page 27).	ON
		<i>OFF</i>
RES ^b (Resolution)	Specifies the output resolution of the video signal (when video input signals are output at the HDMI OUT connector, select this according to the resolution of your monitor and the images you wish to watch).	AUTO
		<i>PURE</i>
		<i>480p/576p</i>
		<i>720p</i>
		<i>1080i</i>
ASP ^c (Aspect)	Specifies the aspect ratio when input signals are output at the HDMI output. Make your desired settings while checking each setting on your display (if the image doesn't match your monitor type, cropping or black bands appear).	THROUGH
		<i>NORMAL</i>
		AUTO
PCINEMA ^{d,e} (PureCinema)	This setting optimizes the operation of the progressive scanning circuit for playing film materials. Normally set it to AUTO . If the picture seems unnatural, switch this to ON or OFF .	AUTO
		<i>ON</i>
		<i>OFF</i>
P.MOTION ^{d,e} (Progressive Motion)	Adjusts the motion and still picture quality when video output is set to progressive.	-4 to +4 Default: 0
YNR ^d	Reduces noise in the luminance (Y) signal.	0 to +8 Default: 0
CNR ^d	Reduces noise in the input's color (C) signal.	0 to +8 Default: 0
BNR ^d	Reduces block noise (block-shaped distortion generated upon MPEG compression) in the picture.	0 to +8 Default: 0
MNR ^d	Reduces mosquito noise (distortion generated at the contours of the picture upon MPEG compression) in the picture.	0 to +8 Default: 0
DETAIL ^d	Adjusts how sharp edges appear.	0 to +8 Default: 0

Setting	What it does	Option(s)
BRIGHT ^d (Brightness)	Adjusts the overall brightness.	-6 to +6 Default: 0
CONTRAST ^d	Adjusts the contrast between light and dark.	-6 to +6 Default: 0
HUE ^d	Adjusts the red/green balance.	-6 to +6 Default: 0
CHROMA ^d (Chroma Level)	Adjusts saturation from dull to bright.	-6 to +6 Default: 0
BLK SETUP ^f	Corrects the black depth in the brightness signal. Normally select 7.5 . If the dark parts of the picture are all black with this setting, select 0 .	7.5 0

a. If the video picture deteriorates when this settings is switched **ON**, switch it **OFF**.

b. • When set to a resolution with which the TV (monitor) is not compatible, no picture is output. Also, in some cases no picture will be output due to copyright protection signals. In this case, change the setting.
• When **AUTO** is selected, the resolution is selected automatically according to the capacity of the TV (monitor) connected by HDMI. When **PURE** is selected, the signals are output with the same resolution as when input (see *About the video converter* on page 27).
• If this is set to something other than **AUTO**, **PURE** and 480i/576i analog signals are input, 480p/576p signals are output from the component output terminals.

c. • If the image doesn't match your monitor type, adjust the aspect ratio on the source component or on the monitor.
• This setting is only displayed when 480i/p or 576i/p video signals are being input.

d. This setting is only displayed when the video signals below are being input:
• 480i, 576i, 480p, 576p, 720p, 1080i analog video signals
• 480i, 576i, 480p, 576p, 720p, 1080i, 1080p, 1080p24 HDMI video signals

e. • This setting is valid for component outputs and HDMI output.
• This setting have the effect only for pictures recorded in the interlaced scan format (480i/576i or 1080i signals).
• **P.MOTION** is disabled when **PCINEMA** is set to **ON**.

f. You can't use this setting when the HDMI or component video signals are being input.

Switching the speaker terminals

If you selected **Speaker B** at *Speaker system setting* on page 115, you can switch between speakers using the **SPEAKERS** button. If you selected **Normal(SB/FH)**, **Normal(SB/FW)**, **Front Bi-Amp** or **ZONE 2**, the button will simply switch your main speaker terminals on or off. The options below are for the **Speaker B** setting only.¹

• Use **SPEAKERS** on the front panel to select a speaker system setting.

As mentioned above, if you have selected **Normal(SB/FH)** or **Normal(SB/FW)**, the button will simply switch your main speaker terminal (A) on or off.

Press repeatedly to choose a speaker terminal option:

- **SP▶A** – Sound is output from the A-speaker terminals (up to 7 channels (including surround back channels), depending on the source).
- **SP▶B** – Sound is output from the two speakers connected to the B-speaker terminals. Multichannel sources will not be heard.
- **SP▶AB** – Sound is output from the A-speaker terminals (up to 5 channels, depending on the source), the two speakers connected to the B-speaker terminals, and the subwoofer. The sound from the B-speaker terminals will be the same as the sound from the A-speaker terminals (multichannel sources will be downmixed to 2 channels).
- **SP▶** (off) – No sound is output from the speakers.

Using the MULTI-ZONE controls

The following steps use the front panel controls to adjust the sub zone volume and select sources. See *MULTI-ZONE remote controls* on page 80.

1 Press **MULTI-ZONE ON/OFF** on the front panel.

Each press selects a MULTI-ZONE option:

- **ZONE 2 ON** – Selects your primary (**ZONE 2**) sub zone
- **ZONE 2&3 ON** – Select both sub zones
- **ZONE 3 ON** – Selects your secondary (**ZONE 3**) sub zone
- **MULTI ZONE OFF** – Switches the MULTI-ZONE feature off

The **MULTI-ZONE** indicator lights when the MULTI-ZONE control has been switched ON.

2 Press **MULTI-ZONE CONTROL** on the front panel to select the sub zone(s) you want.

If you selected **ZONE 2&3 ON** above, you can toggle between **ZONE 2** and **ZONE 3**.

Note

- The subwoofer output depends on the settings you made in *Manual speaker setup* on page 114. However, if **SP▶B** is selected above, no sound is heard from the subwoofer (the LFE channel is not downmixed).
- All speaker systems (except **Speaker B** connections) are switched off when headphones are connected.

- When the receiver is on,¹ make sure that any operations for the sub zone are done while **ZONE** and your selected sub zone(s) show in the display. If this is not showing, the front panel controls affect the main zone only.

3 Use the INPUT SELECTOR dial to select the source for the zone you have selected.

For example, **ZONE 2 CD-R** sends the source connected to the **CD-R** inputs to the primary (**ZONE 2**) sub room.

- If you select **TUNER**, you can use the tuner controls to select a preset station (see *Saving station presets* on page 52 if you're unsure how to do this).²

4 When Speaker System is set to ZONE 2, use the MASTER VOLUME dial to adjust the volume for the sub zone.

5 When you're finished, press MULTI-ZONE CONTROL again to return to the main zone controls.

You can also press **MULTI-ZONE ON/OFF** on the front panel to switch off all output to the sub zone(s).³

MULTI-ZONE remote controls

Set the MULTI-ZONE operation switch to **ZONE 2** or **ZONE 3** to operate the corresponding zone.

The following table shows the possible MULTI-ZONE remote controls:

Button	What it does
	Switches on/off power in the sub zone.
INPUT SELECT	Use to select the input function in the sub zone.
Input function buttons	Use to select the input function directly (this may not work for some functions) in the sub zone.
MASTER VOLUME +/- (SC-35)	Use to set the listening volume in the sub zone. ^a
VOL +/- (SC-37)	
MUTE	Mutes the sound or restores the sound if it has been muted (adjusting the volume also restores the sound). ^a

a. You can only use this button when **Speaker System** is set to **ZONE 2**.

Note

- 1 If the receiver is in standby, the display is dimmed, and **ZONE** and your selected sub zone(s) continue to show in the display.
- 2 The tuner cannot be tuned to more than one station at a time. Therefore, changing the station in one zone also changes the station in the other zone. Please be careful not to change stations when recording a radio broadcast.
- 3 • You won't be able to switch the main zone off completely unless you've switched off the MULTI-ZONE control first.
 - If you don't plan to use the MULTI-ZONE feature for a while, turn off the power in both the sub and main rooms so that this receiver is in standby.
- 4 • The receiver's volume, Audio parameters (the tone controls, for example), and surround effects have no effect on the recorded signal.
 - Some digital sources are copy-protected, and can only be recorded in analog.
 - Some video sources are copy-protected. These cannot be recorded.
- 5 The attenuator isn't available with digital sources, or when using the Stream Direct (ANALOG DIRECT) modes.

Making an audio or a video recording

You can make an audio or a video recording from the built-in tuner, or from an audio or video source connected to the receiver (such as a CD player or TV).⁴

Keep in mind you can't make a digital recording from an analog source or vice-versa, so make sure the components you are recording to/from are hooked up in the same way (see *Connecting your equipment* on page 20 for more on connections).

Since the video converter is not available when making recordings (from the video **OUT** jacks) make sure to use the same type of video cable for connecting your recorder as you used to connect your video source (the one you want to record) to this receiver. For example, you must connect your recorder using Component video if your source has also been connected using Component video.

1 Select the source you want to record.

Use the input function buttons (or **INPUT SELECT**).

2 Prepare the source you want to record.

Tune to the radio station, load the CD, video, DVD etc.

3 Select the input signal according to the signal to be recorded.

Use the remote control's **SIGNAL SEL** button.

4 Prepare the recorder.

Insert a blank tape, MD, video etc. into the recording device and set the recording levels. Refer to the instructions that came with the recorder if you are unsure how to do this. Most video recorders set the audio recording level automatically—check the component's instruction manual if you're unsure.

5 Start recording, then start playback of the source component.

Reducing the level of an analog signal

The input attenuator lowers the input level of an analog signal when it's too strong. You can use this if you find that the **OVER** indicator lights often or you can hear distortion in the sound.⁵

- **Set the remote control to the receiver operation mode, then press A.ATT to switch the input attenuator on or off.**

Using the sleep timer

The sleep timer switches the receiver into standby after a specified amount of time so you can fall asleep without worrying about the receiver being left on all night. Use the remote control to set the sleep timer.

- **Set the remote control to the receiver operation mode, then press SLEEP repeatedly to set the sleep time.**



- You can check the remaining sleep time at any time by pressing **SLEEP** once. Pressing repeatedly will cycle through the sleep options again.¹

Dimming the display

You can choose between four brightness levels for the front panel display. Note that when selecting sources, the display automatically brightens for a few seconds.

- **Set the remote control to the receiver operation mode, then press DIMMER repeatedly to change the brightness of the front panel display.**

Switching the HDMI output

Set which terminal to use when outputting video and audio signals from the HDMI output terminals.

The HDMI OUT1 terminal is compatible with the **Control** with HDMI function.

- **Set the remote control to the receiver operation mode, then press HDMI OUT.** Please wait a while when **Please wait ...** is displayed. The output switches among **HDMI OUT ALL**, **HDMI OUT 1** and **HDMI OUT 2** each time the button is pressed.²

Note

- 1 The sleep timer is valid for all zones. If any zone is on, the sleep timer continues functioning.
- 2 • The synchronized amp mode is canceled when the HDMI output is switched. If you wish to use the synchronized amp mode, switch to **HDMI OUT 1**, then select the synchronized amp mode on the TV using the TV's remote control.
 - When the power is turned off then back on after switching the HDMI output, the input is set to a setting between HDMI1 and HDMI3, or BD.

Using the Web Control function

The receiver can be operated using a browser from a computer connected on the same LAN as the receiver.

- 1 **Turn on the computer and launch the Internet browser.**
- 2 **In the address bar on the browser, enter the IP address assigned to this receiver.**

For example, if the IP address of this receiver is "192.168.0.2", enter "http://192.168.0.2".

When the connection is made with the receiver, a **Top Menu** will be displayed.

This receiver's IP address can be found in the 'IP address, Proxy' menu (page 117).

- 3 **Once the Top Menu is displayed, click the button for the zone you want to operate.**
- 4 **Operate from the screen for the individual zone.**
 - Even when the receiver is in the standby mode, it can be turned on using the **Web Control** function. For details, see *Network Standby* on page 118.

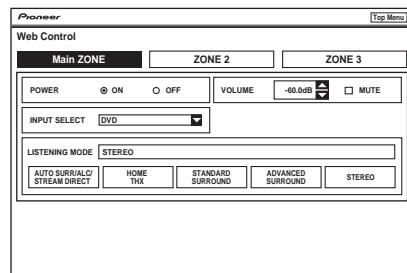

Checking your system settings

Use the status display screen to check your current settings for features such as surround back channel processing and your current MCACC preset.

- 1 **Set the remote control to the receiver operation mode, then press STATUS to check the system settings.** The front panel display shows each of the following settings for three seconds each: **Input function**, **Sampling Frequency**, **MCACC preset**, **ZONE 2 input**, **ZONE 3 input** and **HDMI OUT**.
- 2 **When you're finished, press STATUS again to switch off the display.**

Resetting the system

Use this procedure to reset all the receiver's settings to the factory default. Use the front panel controls to do this. Set **MULTI-ZONE** to **OFF**.

- Disconnect the iPod and USB memory device from the receiver beforehand.

1 Switch the receiver into standby.

2 While holding down ENTER on the front panel, press \odot STANDBY/ON.

The display shows **RESET ◀ NO ▶**.

3 Select 'RESET' using PRESET \leftarrow/\rightarrow , then press ENTER on the front panel.

The display shows **RESET? OK**.

4 Press ENTER to confirm.

OK appears in the display to indicate that the receiver has been reset to the factory default settings.

- Note that all settings will be saved, even if the receiver is unplugged.

Default system settings

Setting	Default
Digital Video Conversion	ON
SPEAKERS	A
Speaker System	Normal (SB/FH)
Speaker Setting	Front
	Center
	FH/FW
	Surr
	SB
	SW
Surround Position	IN REAR
Crossover	80 Hz
X-Curve	OFF
THX Audio Setting	4 ft<
DIMMER	Brightest
Network Standby	OFF
Inputs	
See <i>Input function default and possible settings</i> on page 46.	
HDMI	
HDMI Audio	Amp
HDMI output	HDMI OUT ALL
Control	ON
Control Mode	ALL
Display Power Off	YES

Setting	Default
DSP	
Power On Level	LAST
Volume Limit	OFF
Mute Level	FULL
Phase Control	ON
Sound Retriever	iPod/USB, HOME MEDIA GALLERY (SC-37 only), INTERNET RADIO (SC-35 only), ADAPTER PORT function
	Other functions
Sound Delay	0.0 frame
Dual Mono	CH1
DRC	AUTO
SACD Gain	0 dB
LFE Attenuate	0 dB
Auto delay	OFF
Digital Safety	OFF
Effect Level	ExtendedStereo 90
	Other modes 50
<input checked="" type="checkbox"/> PL II Music Options	Center Width 3
	Dimension 0
	Panorama OFF
Neo:6 Options	Center Image Neo:6 MUSIC: 3 Neo:6 CINEMA: 10
All Inputs	Listening Mode (2 ch/multi ch) AUTO SURROUND
	Listening Mode (HP) STEREO
See also <i>Setting the Audio options</i> on page 76 for other default DSP settings.	
MCACC	
MCACC Position Memory	M1: MEMORY 1
Channel Level (M1 to M6)	0.0 dB
Speaker Distance (M1 to M6)	10.00 ft
Standing Wave (M1 to M6)	ATT of all channels/filters 0.0 dB
	SWch Wide Trim 0.0 dB
EQ Data (M1 to M6)	All channels/bands 0.0 dB
	EQ Wide Trim 0.0 dB

Chapter 10:

Controlling the rest of your system (In case of SC-37)

Important

- This section includes explanations for the SC-37's remote control. For instructions for the SC-35's remote control, see *Controlling the rest of your system (In case of SC-35)* on page 96.

About the Remote Setup menu

The Remote Setup mode is set by pressing the **HOME MENU** button while pressing **MULTI OPERATION**. The different items on the Remote Setup menu are described below. For their setting procedures, refer to the explanations for the respective items.

Setting	What it does
PRESET RECALL	Preset codes can be set for the various input functions. The remote control codes of a number of other devices (including products of other brands) are preset in the remote control to allow these devices to be operated. See "Selecting preset codes directly" on page 84.
CODE LEARNING	If the desired operations cannot be performed even though you have set the preset codes, the remote control signals of other devices can be learned directly. See "Programming signals from other remote controls" on page 85.
MULTI OPERATE	A series of the remote control operations for starting listening or viewing can be programmed. Multiple remote control codes can be set for the different input functions. See "Multi Operation and System Off" on page 87.
SYSTEM OFF	This is a function for automatically turning off the power of devices connected to the receiver. Multiple remote control codes can be set, as desired. See "Multi Operation and System Off" on page 87.
DIRECT FUNC	This is a setting for changing only the remote control unit's operation screen, without changing the receiver's input, when the remote control unit's input function buttons are pressed. This is convenient for using the remote control unit for devices not connected to the receiver. See "Direct function" on page 86.
RENAME	The names of the input function buttons displayed on the remote control unit can be changed as desired. See "Renaming input function names manually" on page 86.

Setting	What it does
SYNC RENAMING	Input function names changed on the receiver can be acquired by the remote control unit so that the names are the same on the remote control unit. See "Renaming input function names in synchrony with the receiver" on page 93.
ERASE LEARNING	This function is used to erase remote control codes that have been learned. Codes learned for the different input functions can be erased individually. See "Erasing one of the remote control button settings" on page 85.
IR/RF SELECT	This function is for selecting wireless (RF) or infrared (IR) as the remote control operating mode for the different devices. See <i>Operating this receiver by RF communications</i> and <i>Operating other components by RF communications</i> on page 92.
OPERATION MODE	The remote control unit's operation screen switches automatically when the receiver's input is switched (This is only valid when the operation selector switch is set to SOURCE). See "Setting the remote control operation mode" on page 94.
KEY RESET	This is a function for resetting preset codes that have been set. Key resetting can be done for individual input functions. See "Resetting the input assignment of one of the input function buttons" on page 86.
ALL RESET	This is a function for resetting all remote control unit settings you have made to the defaults set upon shipment from the factory. See "Resetting the remote control settings" on page 86.
READ PRESET ID	The preset codes set for the different input functions can be checked. See "Confirming preset codes" on page 86.
CHANGE RC MODE	If you have multiple Pioneer receivers, amplifiers, etc., this setting can be used to prevent other units from operating simultaneously when the remote control unit is operated. See "Operating multiple receivers" on page 84.
EXIT SETUP	Exits the setup menu.

Note

- You can cancel or exit any of the steps by press and hold **MULTI OPERATION** for a couple of seconds. To go back a step, press **RETURN**.
- After one minute of inactivity, the remote automatically exits the operation.

Operating multiple receivers

The remote control included with this receiver can be used to operate up to three other receivers (of the same model as this receiver) in addition to this receiver. The receiver to be operated is switched by inputting the preset code to set the remote control setting.

- Set the remote modes on the receivers before using this function (see *Remote Control Mode Setup* on page 119).

1 Check that the remote control's MULTI-ZONE selector switch is set to MAIN and that the operation selector switch is set to RECEIVER.

2 While pressing MULTI OPERATION, press HOME MENU.

The remote display shows **SETUP MENU**.

3 Use ↑/↓ to select 'CHANGE RC MODE', then press ENTER.

4 Use ↑/↓ to select the remote mode. RC MODE 1 to 4 can be selected.

5 Press ENTER to set the remote mode.
The selected mode flashes for 3 seconds.

To operate another receiver, start over from step 1 to input its preset code.

Setting the remote to control other components

Most components can be assigned to one of the input function buttons (such as **DVD** or **CD**) using the component's manufacturer preset code stored in the remote.

However, there are cases where only certain functions may be controllable after assigning the proper preset code, or the codes for the manufacturer in the remote control will not work for the model that you are using.

If you can't find a preset code that matches the component you want to control, you can still teach the remote individual commands from another remote control (see *Programming signals from other remote controls* on page 85).

- For greater convenience, assign the TV connected to the MONITOR OUT terminal to the **TV** operation selector switch, and assign your satellite/cable receiver or set-top box connected to the TV input

terminal to the **TV** input button. If a single device is connected to both terminals, that device should be assigned to both the **TV** operation selector switch and **TV** input buttons.

- Devices may be assigned to the following input function buttons.

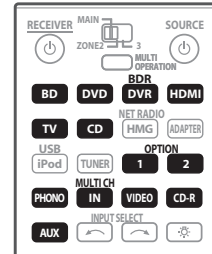

Selecting preset codes directly

1 While pressing MULTI OPERATION, press HOME MENU.

The remote display shows **SETUP MENU**.

2 Use ↑/↓ to select 'PRESET RECALL', then press ENTER.

3 Press the input function button for the component you want to control, then press ENTER.

When assigning preset codes to **TV CONTROL**, set the remote control operation selector switch to **TV** here.

The remote display shows the component you want to control (for example **DVD** or **TV**).¹

4 Use ↑/↓ to select the first letter of the brand name of your component, then press ENTER.

This should be the manufacturer's name (for example, **P** for Pioneer).

5 Use ↑/↓ to select the manufacturer's name from the list, then press ENTER.

6 Use ↑/↓ to select the proper code from the list, then try using this remote with your component.

The code should start with the component type (for example, **DVD 020**). If there is more than one, start with the first one.²

To try out the remote control, switch the component on or off (into standby) by pressing **⏻ SOURCE**. If it doesn't seem to work, select the next code from the list (if there is one).

Note

¹ You can't assign **TUNER**, **HMMG NET RADIO**, **ADAPTER** and **iPod USB**. Preset codes can be assigned to the **OPTION 1** and **OPTION 2** buttons. Note, however, that Sirius is pre-assigned to **OPTION 1**, XM to **OPTION 2**, and if other preset codes are assigned, Sirius and XM operations can no longer be performed. If you accidentally assign other codes to one of these buttons, it is possible to reset that button only (see *Resetting the input assignment of one of the input function buttons* on page 86).

² • When using a Pioneer HDD recorder, please select **PIONEER DVR 450, 451 or 452**.
• When using a Pioneer flat panel TV released prior to summer 2005, please select preset code **644**.

- If you can't find or properly enter a preset code, you can still teach the remote individual commands from another remote control (see *Programming signals from other remote controls* below).

7 If your component is controlled successfully, press ENTER to confirm.

The remote display shows **OK**.

Programming signals from other remote controls

If the preset code for your component is not available, or the available preset codes do not operate correctly, you can program signals from the remote control of another component. This can also be used to program additional operations (buttons not covered in the presets) after assigning a preset code.¹

1 While pressing MULTI OPERATION, press HOME MENU.

The remote display shows **SETUP MENU**.

2 Use ↑/↓ to select 'CODE LEARNING', then press ENTER.

The remote display prompts you for the component you want to control (for example **DVD** or **TV**).

3 Press the input function button for the component you want to control, then press ENTER.

PRESS KEY blinks in the remote display.²

4 Point the two remote controls towards each other, then press the button that will be doing the learning on this receiver's remote control.

PRESS KEY lights continuously to indicate the remote is ready to accept a signal.

- The remote controls should be 3 cm (1 inch) apart.

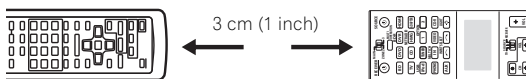

5 Press the corresponding button on the other remote control that is sending (teaching) the signal to this receiver's remote control.

For example, if you want to learn the playback control signal, press and hold **▶** briefly. The remote display will show **OK** if the operation has been learned.³

Note

- 1 The remote can store about 200 preset codes (this has been tested with codes of Pioneer format only).
- 2 • You can't assign **TUNER**, **HMG NET RADIO**, **ADAPTER** and **iPod USB**.
• The **TV CONTROL** buttons (**TV**, **TV VOL +/-**, **TV CH +/-**, **MUTE** and **INPUT**) can only be learned after the operation selection switch is set to **TV**.
- 3 Note that interference from TVs or other devices will sometimes result in the remote control learning the wrong signal.
- 4 • Some commands from other remote controls cannot be learned, but in most cases the remotes just need to be moved closer together or farther apart.
• If the remote display shows **MEMORY FULL**, it means the memory is full. See *Erasing one of the remote control button settings* on page 85 to erase a programmed button you're not using to free up more memory (note that some signals may take more memory than others).
• Depending on the type of command that has been learned, operation may not be possible with RF two-way communications. In this case, operate using IR signal transmission. For instructions on switching between the IR and RF modes, see *Operating other components by RF communications* on page 92.

If for some reasons the operation hasn't been learned the remote display will show **ERROR** briefly, and then display **PRESS KEY** again. If this happens, keep pressing the (teaching) button as you vary the distance between the two remotes, until the remote display shows **OK**.⁴

Certain buttons represent operations that cannot be learned from other remote controls. The buttons available are shown below:

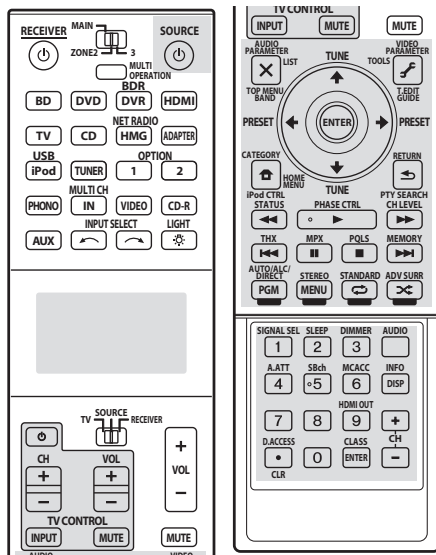

6 To program additional signals for the current component repeat steps 4 and 5.

To program signals for another component, exit and repeat steps 1 through 5.

7 Press and hold MULTI OPERATION for a couple of seconds to exit and store the operation(s).

Erasing one of the remote control button settings

This erases one of the buttons you have programmed and restores the button to the factory default.

1 While pressing MULTI OPERATION, press HOME MENU.

The remote display shows **SETUP MENU**.

- 2 Use ↑/↓ to select 'ERASE LEARNING', then press ENTER.**

The remote display prompts you for the component corresponding to the button setting to be erased.

- 3 Press the input function button corresponding to the command to be erased, then press ENTER.**

The remote display flashes **PRESS KEY**.

- 4 Press and hold the button to be erased for two seconds.**

The remote display shows **OK** or **NO CODE** to confirm the button has been erased.

- 5 Repeat step 4 to erase other buttons.**

- 6 Press and hold MULTI OPERATION for a couple of seconds when you're done.**

Resetting the input assignment of one of the input function buttons

This procedure resets the input assignment preset at the remote control's input function button, restoring the default.

- 1 While pressing MULTI OPERATION, press HOME MENU.**

The remote display shows **SETUP MENU**.

- 2 Use ↑/↓ to select 'KEY RESET', then press ENTER.**

The remote display prompts you for the component corresponding to the button setting to be erased.

- 3 Press the input function button for the component whose input assignment you want to reset, then press and hold ENTER for a couple of seconds.**

The remote display shows **OK** when the input assignment of the remote control's input function button is reset.

Resetting the remote control settings

Use this procedure to reset all the remote control's settings to the factory default.¹

- 1 While pressing MULTI OPERATION, press HOME MENU.**

The remote display shows **SETUP MENU**.

- 2 Use ↑/↓ to select 'ALL RESET', then press ENTER. ALL RESET flashes in the remote display.**

- 3 Press and hold ENTER for about two seconds.**

The remote display shows **OK** to confirm the remote presets have been erased.

Note

¹ When *Selecting preset codes directly* on page 84 are set, all the signals learned in the input function buttons are cleared. This function is convenient when you want to reset some but not all of input function buttons.

² The **TV CONTROL** name can be changed when the remote control operation selector switch is switched to **TV**. To change the names of the input functions, set the remote control operation selector switch to **SOURCE**.

Confirming preset codes

Use this feature to check which preset code is assigned to an input function button.

- 1 While pressing MULTI OPERATION, press HOME MENU.**

The remote display shows **SETUP MENU**.

- 2 Use ↑/↓ to select 'READ PRESET ID', then press ENTER.**

The remote display prompts you for the input function button you want to check.

- 3 Press the input function button of the component for which you want to check the preset code, then press ENTER.**

The brand name and preset code appears in the display for three seconds.

Renaming input function names manually

You can customize the names that appear on the remote display when you select an input function (for example, you could change the name of **DVR** to **HDD/DVR**).

- 1 While pressing MULTI OPERATION, press HOME MENU.**

The remote display shows **SETUP MENU**.

- 2 Use ↑/↓ to select 'RENAME', then press ENTER.**

The remote display prompts you for the button of the input function you want to rename.

- 3 Press the input function button you want to rename then press ENTER.²**

- 4 Use ↑/↓ to select 'NAME EDIT', then press ENTER.** To reset the button to its original (default) name, select **NAME RESET** above.

- 5 Edit the name of the input function in the remote control display, pressing ENTER when you're finished.** Use ↑/↓ to change the character and ←/→ to move forward/back a position. The name can be up to 14 characters.

Direct function

- Default setting: **ON**

You can use the direct function feature to control one component using the remote control while at the same time, using your receiver to playback a different component. This could let you, for example, use the

remote control to set up and listen to a CD on the receiver, and then use the remote control to rewind a tape in your VCR while you continue to listen to your CD player.

When direct function is on, any component you select (using the input function buttons) will be selected by both the receiver and the remote control. When you turn direct function off, you can operate the remote control without affecting the receiver.

1 While pressing MULTI OPERATION, press HOME MENU.

The remote display shows **SETUP MENU**.

2 Use ↑/↓ to select 'DIRECT FUNC', then press ENTER.

The remote display prompts you for the button of the input function you want to control.

3 Press the input function button for the component you want to control, then press ENTER.¹

4 Use ↑/↓ to switch direct function ON or OFF, then press ENTER.

The remote display shows **OK** to confirm the setting.

Multi Operation and System Off

The Multi Operation feature allows you to program a series of up to 6 commands for the components in your system. For example, you could turn on your TV, turn on your DVD player and start playing the loaded DVD using only two buttons on the remote control.

Similar to multi operations, System Off allows you to use one button to stop and switch off a series of components in your system at the same time.²

Programming a multi-operation or a shutdown sequence

Set the remote control operation mode selector switch to **RECEIVER** when you want to program this receiver's operations, to **SOURCE** when you want to program operations of other components.

1 While pressing MULTI OPERATION, press HOME MENU.

The remote display shows **SETUP MENU**.

2 Use ↑/↓ to select 'MULTI OPERATE' or 'SYSTEM OFF' from the menu and press ENTER.

If you selected *Multi Operation* (**MULTI OPERATE**), the remote display prompts you for an input function button.

If you selected *System Off* (**SYSTEM OFF**), go to step 4.

3 Press the input function button for the component that will start the multi-operation, then press ENTER.

For example, if you want to start the sequence by switching on your DVD player, press **DVD**.

4 Use ↑/↓ to select 'EDIT CODE', then press ENTER.

To erase any previously stored multi-operations (or shutdown sequences) select **CLEAR CODE** above.

5 Use ↑/↓ to select a command in the sequence, then press ENTER.

If this is the first command in the sequence, select **1st CODE**. Otherwise, simply choose the next command in the sequence. **PRESS KEY** flashes after you press **ENTER**.

6 If necessary, press the input function button for the component whose command you want to input.

This is only necessary if the command is for a new component (input function).

7 Select the button for the command you want to input.

The following remote control commands can be selected:

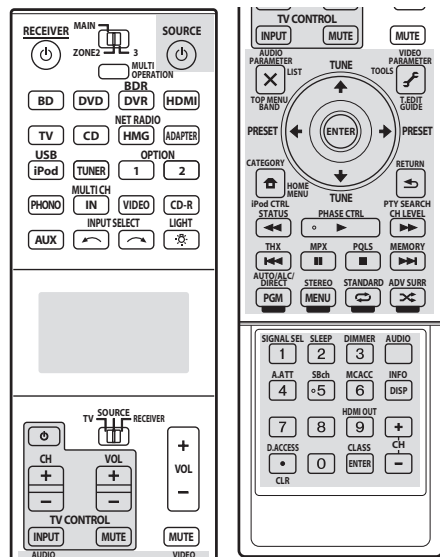

- You don't need to program the receiver to switch on or off. This is done automatically.

With Pioneer components, you don't need to:

- program the power to switch off in a shutdown sequence (except DVD recorders);

These take priority in multi operations (not shutdown).

Note

¹ You can't use direct function **TUNER**, **HMG NET RADIO**, **ADAPTER** and **iPod USB**.

² • Before Multi Operation and System Off will work correctly, you must setup the remote to work with your TV and other components (see *Setting the remote to control other components* on page 84 for more on this).

- Some units may take some time to power up, in which case multiple operations may not be possible.
- Power on and off commands only work with components that have a standby mode.
- Up to 5 commands can be programmed for System Off.

8 Repeat steps 5 to 7 to program a sequence of up to commands.

9 When you're finished, use \uparrow/\downarrow to select 'EDIT EXIT' from the menu and press ENTER.

You will return to the remote control Setup menu. Select EXIT SETUP to exit.

Using multi operations

You can start multi operations with the receiver switched on, or in standby.

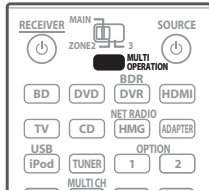

1 Press MULTI OPERATION.

MULTI OPERATE flashes in the display.

2 Press an input function button that has been set up with a multi operation.

The receiver switches on (if it was in standby) and the programmed multi operation is performed automatically.¹

Using System off

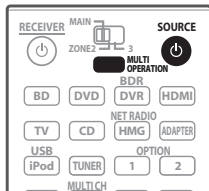

1 Press MULTI OPERATION.

MULTI OPERATE flashes in the display.

2 Press SOURCE.

The command sequence you programmed will run, then all Pioneer components will switch off², followed by this receiver.³

Controlling components

This remote control can control components after entering the proper codes (see *Selecting preset codes directly* on page 84). Set the remote control operation selector switch to **SOURCE**, then press the input function buttons to select the component.

- **TV CONTROL** on the remote control are dedicated to control the TV assigned to the **TV** operation selector switch. If you have two TVs, assign the main TV to the **TV** operation selector switch.

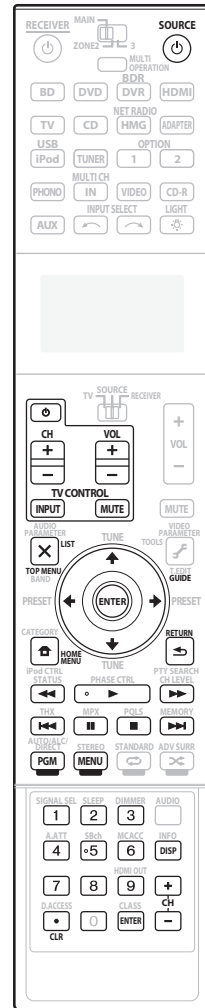

Note

- 1 With this remote control, the IR and RF modes can be selected separately for the individual input functions. To perform a multi operation on a device (input function) for which the IR mode is selected, point the remote control toward the remote sensor on that device.
- 2 In order to avoid accidentally switching off a DVD recorder that is currently recording, no DVD recorder power off codes are sent.
- 3 • With this remote control, the IR and RF modes can be selected separately for the individual input functions. To turn off the power of a device (input function) for which the IR mode is selected using the System Off function, point the remote control toward the remote sensor on that device.
 - When the power code of another brand is registered, the power on/off operation may be inverted. When using the System Off function for a multi operation including the power codes of other brands, always check that the power of all the components has turned off.

Button(s)	TV	TV (Monitor)	BD/DVD	HDD/DVR	VCR	SAT/CATV
SOURCE	POWER ON/OFF	POWER ON/OFF	POWER ON/OFF	POWER ON/OFF	POWER ON/OFF	POWER ON/OFF
Number buttons	<i>numerics</i>	<i>numerics</i>	<i>numerics</i>	<i>numerics</i>	<i>numerics</i>	<i>numerics</i>
• (dot)	• (dot)	KURO LINK	CLEAR	+	-	*
ENTER (CLASS)	CH ENTER	CH ENTER	ENTER	CLEAR	-	ENTER
	EXIT/INFO	EXIT	TOP MENU	TOP MENU/ DISC NAVI	-	LIST
	TOOLS/GUIDE	USER MENU	TOOLS ^a	GUIDE	-	GUIDE
					-	
ENTER	ENTER	ENTER	ENTER	ENTER	-	ENTER
	HOME MENU	HOME MENU	HOME MENU	HOME MENU	-	HOME
	RETURN	RETURN	RETURN	RETURN	-	RETURN
PGM (Red)	<i>Red</i>	<i>Red</i>	-	HDD/DVD	-	<i>Red</i>
MENU (Green)	<i>Green</i>	<i>Green</i>	-	MENU	-	<i>Green</i>
(Yellow)	<i>Yellow</i>	<i>Yellow</i>	-	VCR	-	<i>Yellow</i>
(Blue)	<i>Blue</i>	<i>Blue</i>	MENU	TV/DTV	-	<i>Blue</i>
	-	-				
	-	AUTO SETUP				C/
	-	FREEZE				D/
	-	-				A/
	-	-				
	ANT	AV SELECTION				B/
	-	SCREEN SIZE				E/
AUDIO	AUDIO	AUDIO	AUDIO	AUDIO	AUDIO	AUDIO
DISP	DISPLAY	DISPLAY	DISPLAY	DISPLAY	-	DISPLAY/INFO
CH +/-	CH +/-	CH +/-	OUTPUT RESOLUTION +/- ^a	CH +/-	CH +/-	CH +/-
	-	-	-	-	-	RECORD

a.Controls for BD.

Button(s)	LD	CD/CD-R/SACD	MD/DAT	TAPE
SOURCE	POWER ON/OFF	POWER ON/OFF	POWER ON/OFF	POWER ON/OFF
Number buttons	<i>numerics</i>	<i>numerics</i>	<i>numerics</i>	–
• (<i>dot</i>)	+10	>10/CLEAR	CLEAR ^a	CLEAR
ENTER (CLASS)	ENTER	DISC/ENTER	–	ENTER
	TOP MENU	–	–	–
	–	LEGATO LINK ^b	–	–
		–	–	
ENTER	ENTER	–	–	
	–	SACD SETUP ^b	–	–
	RETURN	–	–	–
PGM (<i>Red</i>)		PROGRAM		
(<i>Yellow</i>)		REPEAT		
(<i>Blue</i>)		SHUFFLE		
			/MS ^{-c}	
			/MS ^{+c}	
AUDIO	AUDIO	PURE AUDIO ^b	–	–
DISP	DISPLAY/INFO	TIME ^b	–	–

a.Controls for MD.
b.Controls for SACD.
c.Controls for DAT.

Button(s)	TV (Projector)
SOURCE	POWER ON
1	MOVIE
2	STANDARD
3	DYNAMIC
4	USER1
5	USER2
6	USER3
7	COLOR+
8	SHARP+
9	GAMMA
0	COLOR–
• (<i>dot</i>)	SHARP–
ENTER (CLASS)	COLOR TEMP
	EXIT
	INFO
ENTER	ENTER
	TEST
	HIDE
	MENU
	HDMI1
	HDMI2
	COMP.
	VIDEO
	S-VIDEO
	BRIGHT–
	BRIGHT+
AUDIO	POWER OFF
DISP	ASPECT
CH +/-	CONTRAST+/-

Using the RF communications function

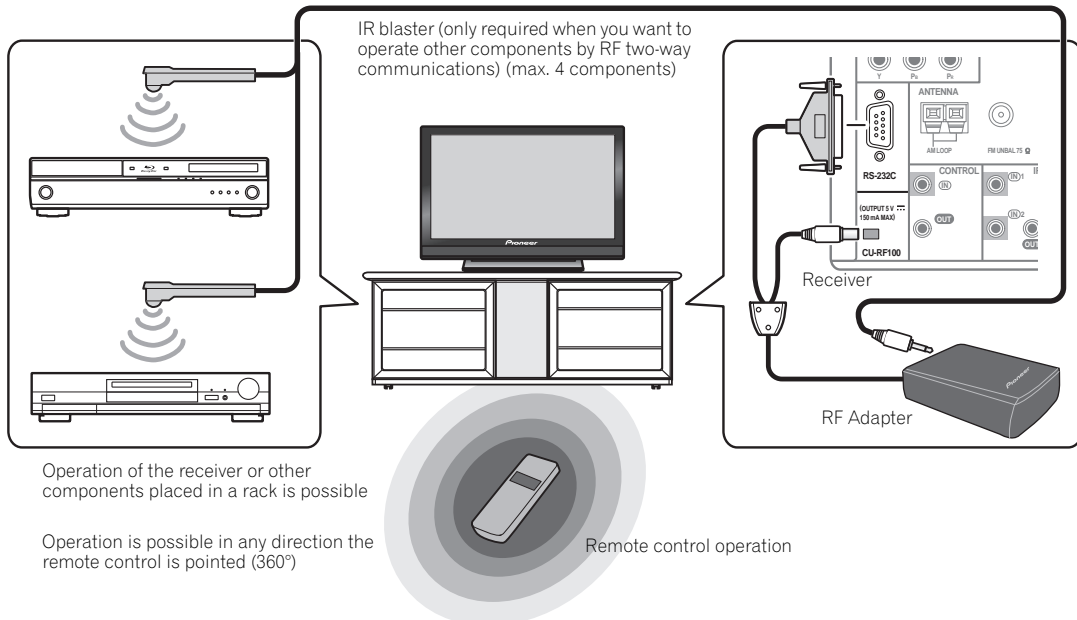

With this receiver, two-way communications between the receiver and remote control are possible by connecting the included RF adapter to the RS-232C and CU-RF100 terminals. For instructions on connecting the RF adapter, see *Connecting the RF adapter (SC-37 only)* on page 21. Two-way communications allow you to use the following functions:

- The receiver can be operated by pointing the remote control in any direction (360°) (maximum line-of-sight distance for two-way communications: about 10 meters).
- Operate is possible without being affected by obstacles (even products in racks can be operated).
- The information shown on the receiver's display can be displayed on the remote control's display as you operate.
- RF communications can be used to operate up to 4 other components connected to the receiver (using the included IR blaster. For details, see *Operating other components by RF communications* on page 92).
- The remote control input display names can be synchronized with the input names changed at **Input Name** on the receiver's **Input Setup** menu (page 45) and acquired automatically. For details, see *Renaming input function names in synchrony with the receiver* on page 93.

- When the receiver's input is switched, the remote control's display and operating mode switch to that input automatically. For details, see *Setting the remote control operation mode* on page 94.

Important

- The line-of-sight communications distance is a rough indication, and may differ according to the surrounding environment.
- Depending on the communications environment, functions using two-way communications between the receiver and remote control may not operate properly. For details, including cautions on the communications environment and usage procedure, etc., see *Precautions when using the Omni-Directional RF Remote Control* on page 94.

Note

- You can cancel or exit any of the steps by press and hold **MULTI OPERATION** for a couple of seconds. To go back a step, press **RETURN**.

Pairing the RF adapter and remote control

Pairing is necessary in order to use the RF communications function. Perform the operation below after connecting the RF adapter and receiver.

- 1 **Switch on the receiver.**
- 2 **Set the RF Remote Setup on this receiver's Other Setup menu to ON.**
For details, see *RF Remote Setup (SC-37 only)* on page 120
- 3 **Press the SETTING button on the front of the RF adapter.**
RF adapter's LED blinks red.
- 4 **While pressing MULTI OPERATION, press VIDEO PARAMETER on the remote control.**
The remote display shows **PAIRING**.

5 **Press ENTER on the remote control.**
AUTHORIZATION flashes and pairing is performed. When pairing is successful, **SUCCESS** is displayed and pairing is completed. RF adapter's LED lights green. The display on the receiver itself is displayed on the remote control's display. For details, see *Remote control display* on page 13.

If **ERROR** is displayed, pairing has not been successful. Check the connections and distance with the RF adapter, then start over from step 1.

The remote control unit's receiver operation mode must be set to "RF" in order to operate the receiver with RF two-way communications. Make this setting as described at *Operating this receiver by RF communications* below.

Operating this receiver by RF communications

Use this procedure to make the remote control settings to operate the receiver using RF two-way communications. The settings can be made individually for the main zone, ZONE 2 and ZONE 3. Connect the receiver and RF adapter and pair the RF adapter and remote control unit beforehand.

- 1 **While pressing MULTI OPERATION, press HOME MENU.**

The remote display shows **SETUP MENU**.

- 2 Use \uparrow/\downarrow to select 'IR/RF SELECT', then press **ENTER**.

Check that the units are paired. If **RECEIVER MAIN** is displayed, pairing has been performed properly, so proceed to step 3. If **RF MODE ONLY** flashes, pairing has not been performed properly, so perform this procedure again after performing pairing (see *Pairing the RF adapter and remote control* on page 92).

- 3 Use \uparrow/\downarrow to select the receiver zone for which you want to use RF two-way communications, then press **ENTER**.

- 4 Use \uparrow/\downarrow to select 'RF MODE', then press **ENTER**.¹
Select **IR MODE** to return to operation by infrared signal.

- 5 **If you want to operate other zones with RF two-way communications, repeat steps 3 and 4.**

Operating other components by RF communications

Up to 4 other components connected to the receiver can be operated by RF communications. Use the IR blaster to communicate between the RF adapter and other components, and switch the remote control's setting to RF. The remote control's setting can be switched individually for each input.

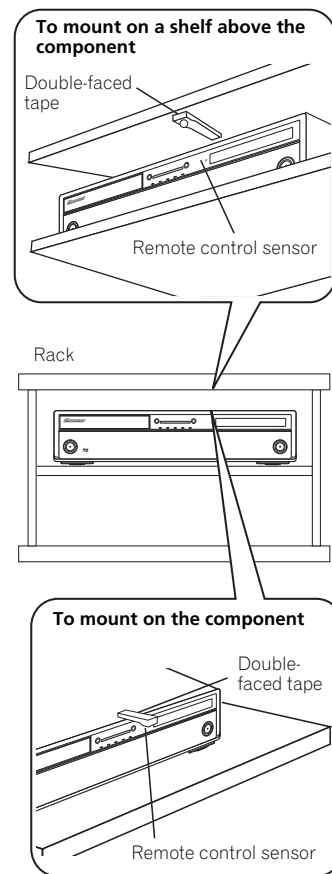

Note

¹ When **RECEIVER** is selected and **RF MODE** is set at step 3, **HMG NET RADIO, ADAPTER, iPod USB** and **TUNER** are automatically set to the RF mode. Note that **RF MODE** cannot be set for **OPTION 1** and **OPTION 2**.

1 Connect the IR blaster cable to the RF Adapter's IR Blaster terminal and mount the transmitter on the component you want to operate with RF communications.

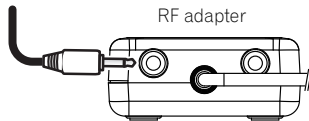

- Operation is not possible unless the IR blaster is mounted in an appropriate position. Whenever possible, mount it above the other component's remote control sensor. If mounted below, the influence of external light, etc., could hamper reception.
- Mount the IR blaster securely to a position near the other component's remote control sensor. For the location of the other component's remote control sensor, see the component's operating instructions.
- Clean any dirt or dust off the place at which the double-faced tape is to be attached beforehand.
- Note that the double-faced tape is strong, and that trying to peel it off the shelf, etc., after it has been applied may damage the shelf's surface.

2 While pressing MULTI OPERATION, press HOME MENU.

The remote display shows **SETUP MENU**.

3 Use ↑/↓ to select 'IR/RF SELECT', then press ENTER.

Check that the units are paired. If **RECEIVER MAIN** is displayed, pairing has been performed properly, so proceed to step 4. If **RF MODE ONLY** flashes, pairing has not been performed properly, so perform this procedure again after performing pairing (see *Pairing the RF adapter and remote control* on page 92).

4 Use ↑/↓ to select input function for the component you want to operate using RF communications, then press ENTER.

Select the input component to which the IR blaster was mounted in step 1.

5 Use ↑/↓ to select 'RF MODE', then press ENTER.

Select **IR MODE** to return to operation by infrared signal.

6 If other input function buttons also switch to RF communications operation, repeat step 4 to 5.

7 Press and hold MULTI OPERATION for a couple of seconds to exit and store the operation(s).

Renaming input function names in synchrony with the receiver

- Default setting: **MANUAL**

The remote control input display names can be synchronized with the input names that have been changed at **Input Name** on the receiver's **Input Setup** menu (page 45) and acquired automatically. There are two modes: **AUTO** in which the receiver's input names are acquired automatically each time the input is switched, and **MANUAL** in which the receiver's input names are only acquired for input functions selected manually. Even when input names are changed manually at *Renaming input function names manually* on page 86, when synchro renaming is performed here, the input name is overwritten.

1 While pressing MULTI OPERATION, press HOME MENU.

The remote display shows **SETUP MENU**.

2 Use ↑/↓ to select 'SYNC RENAMING', then press ENTER.

MANUAL flashes in the remote display.¹

3 Use ↑/↓ to select 'AUTO' or 'MANUAL', then press ENTER.

If you selected **AUTO**, this completes the setting. The receiver's input names are acquired automatically in synchrony with the receiver each time the remote control's input is switched. Proceed to step 7.

If you selected **MANUAL**, go to step 4.

4 Press the input function button for the component whose receiver input name you want to acquire, then press ENTER.²

The receiver's input name is acquired. After **PLEASE WAIT** is displayed, the receiver's input name flashes. If the name has not been changed at **Input Name** on the receiver's **Input Setup** menu (page 45), **NO CHANGE** flashes.

5 Press ENTER to enter the input name displayed on the remote control.

COMPLETE is displayed and the input name is registered.

6 To acquire the receiver input names for other input function buttons, repeat step 4 to 5.

7 Press and hold MULTI OPERATION for a couple of seconds to exit and store the operation(s).

Note

¹ If **RF MODE ONLY** flashes, pairing has not been performed properly or **RECEIVER** may be set to **IR MODE** at the remote control's **IR/RF SELECT** setting. In this case, perform pairing, then switch **RECEIVER** to **RF MODE** at the remote control's **IR/RF SELECT** setting. For details, see *Pairing the RF adapter and remote control* on page 92 and *Operating this receiver by RF communications* on page 92.

² The **HDMI** input function button is not supported.

Setting the remote control operation mode

- Default setting: **ON**

When the remote control operation mode is turned on and the receiver's input is switched, the remote control display and operation mode switch automatically to that input. Select **OFF** if you do not want the remote control's function to switch automatically when the receiver's input is switched.¹

1 While pressing **MULTI OPERATION**, press **HOME MENU**.

The remote display shows **SETUP MENU**.

2 Use **↑/↓** to select '**OPERATION MODE**', then press **ENTER**.

Check that the units are paired. If **SYNCHRO ON** is displayed, pairing has been performed properly, so proceed to step 3. If **RF MODE ONLY** flashes, pairing has not been performed properly, so perform this procedure again after performing pairing (see *Pairing the RF adapter and remote control* on page 92).

3 Use **↑/↓** to select '**SYNCHRO ON**' or '**SYNCHRO OFF**', then press **ENTER**.

The remote display shows **OK** to confirm the setting.

4 Press and hold **MULTI OPERATION** for a couple of seconds to exit and store the operation(s).

Precautions when using the Omni-Directional RF Remote Control

Precautions regarding wavelength

- This remote control is designed to prevent other persons from eavesdropping on the transmitted signals, but precautions should nonetheless be taken against the chance that other persons' could intercept and listen to the signals transmitted. Given that this remote control produces radio wave transmissions, another person could deliberately use a receiver to attempt to intercept such transmissions. As a result, this device should not be used to play important transmissions demanding privacy.

This remote control utilizes the 2.4 GHz frequency band. This band is also used by a variety of other devices as noted below. In particular, devices not often cognizant to the user are listed in item 2.

1 Examples of common devices utilizing the 2.4 GHz band:

- Cordless phone
- Cordless facsimile
- Microwave oven
- Wireless LAN router
- Wireless AV device
- Wireless controllers for games
- Microwave therapeutic devices
- *Bluetooth* wireless technology devices

2 Other devices using 2.4 GHz:

- Shoplifting-prevention systems
- Amateur wireless radio
- Distribution control systems at factories and warehouses
- Railway and emergency vehicle wireless identification systems

When such devices are used simultaneously with this remote control, signal interference may occur, resulting in signal dropouts.

To improve reception quality, try the following:

- Turn off the other device emitting radio waves.
- Place the interfering device farther away (Move both the remote control and RF adapter away from the interfering device).

Do not use this remote control in the following locations, since transmission interruption may result:

- Locations where another device using the same 2.4 GHz frequency is being used, such as a Bluetooth wireless technology device or wireless LAN, or in the vicinity where the magnetic field, static electricity, or radio wave interference from another device may occur (depending on the environment, radio waves may not transmit effectively).
- Move the radio farther away.
- If visual noise appears on the television screen, it is possible that this remote control is producing adverse influence on the antenna input of the television, video device, BS tuner, or CS tuner. Move this remote control farther away from the antenna input of the affected device.

Note

¹ • When the remote control's input is switched, the receiver's input also switches, but for functions for which the remote control direct function (page 86) is set to off, when the remote control's input is switched, the receiver's input does not switch and only the remote control unit's operating screen switches.

- The remote control operation mode is only valid when the remote control operation selector switch is set to **SOURCE**.

Usable range

- Designed for use only within private homes (signal transmission distance may be reduced due to room design or conditions).

In the following cases, this remote control cannot operate due to poor or erratic radio wave transmission.

- When signal transmission is blocked by a wall or floor constructed of ferro-concrete or metal.
- Nearby large metal furniture objects
- In large crowds of people, or near obstructive buildings.
- Locations where another device using the same 2.4 GHz frequency is being used, such as a Bluetooth wireless technology device or wireless LAN, or in the vicinity where the magnetic field, static electricity, or radio wave interference from another device may occur.
- When living in a housing complex (apartment, condominium, etc.) where the next-door unit has a microwave oven located near to this remote control. Note that even a microwave oven will not interfere with this remote control when not in use.
- When using multiple Omni-Directional RF Remote Control in the same location.

- Persons using pacemakers or other medical or therapeutic electronic devices should consult the manufacturer or dealer of their device regarding the potential effects of radio waves from this remote control.
- Do not use in aircraft, hospitals, or other locations where the use of radio-wave-generating devices is prohibited, since adverse affects may be caused to flight communications equipment or medical devices. Follow all precautions and directives given by medical institutions.

Signal reflection

- The signals reaching the remote control include those transmitted in a straight line from the main unit (direct waves), and those that are received after being bounced off of walls, furniture, and other buildings (reflected waves).

As a result, reflected waves can be generated by obstacles and other reflective objects, causing variations in the signal quality. In such cases, try slightly changing the position of the remote control.

CAUTION

- With the exception of cases determined by law to be the subject of legal liability, Pioneer refuses all responsibility for any harm resulting to the customer or other person as a result of the use of this remote control.

For safe use

- Do not use near electronic devices utilizing high-precision or very delicate radio waves, since the other device may operate incorrectly, resulting in malfunction.

Examples of devices requiring particular caution:

- Hearing aids, pacemakers and other medical or therapeutic electronic devices, fire/smoke detectors, automatic door openers, other automatic devices.

Controlling the rest of your system (In case of SC-35)



Important

- This section includes explanations for the SC-35's remote control. For instructions for the SC-37's remote control, see *Controlling the rest of your system (In case of SC-37)* on page 83.

About the Remote Setup menu

The Remote Setup mode is set by pressing the number button while pressing **R.SETUP**. The different items on the Remote Setup menu are described below. For their setting procedures, refer to the explanations for the respective items.

Setting	What it does
Preset recall	Preset codes can be set for the various input functions. The remote control codes of a number of other devices (including products of other brands) are preset in the remote control to allow these devices to be operated. See "Selecting preset codes directly" on page 97.
Code learning	If the desired operations cannot be performed even though you have set the preset codes, the remote control signals of other devices can be learned directly. See "Programming signals from other remote controls" on page 97.
Multi operation	A series of the remote control operations for starting listening or viewing can be programmed. Multiple remote control codes can be set for the different input functions. See "Multi operation and System off" on page 99.
System off	This is a function for automatically turning off the power of devices connected to the receiver. Multiple remote control codes can be set, as desired. See "Multi operation and System off" on page 99.
Direct function	This is a setting for changing only the remote control unit's operation screen, without changing the receiver's input, when the remote control unit's input function buttons are pressed. This is convenient for using the remote control unit for devices not connected to the receiver. See "Direct function" on page 98.
Erase learning	This function is used to erase remote control codes that have been learned. Codes learned for the different input functions can be erased individually. See "Erasing one of the remote control button settings" on page 98.
Back light	The backlight lighting pattern can be selected from among four modes, in consideration of convenience and battery service life. See "Setting the backlight mode" on page 99.

Setting	What it does
Reset function	This is a function for resetting preset codes that have been set. Key resetting can be done for individual input functions. See "Erasing all learnt settings that are in one input function" on page 98.
All reset	This is a function for resetting all remote control unit settings you have made to the defaults set upon shipment from the factory. See "Resetting the remote control settings" on page 101.
Change RC mode	If you have multiple Pioneer receivers, amplifiers, etc., this setting can be used to prevent other units from operating simultaneously when the remote control unit is operated. See "Operating multiple receivers" on page 96.



Note

- You can cancel or exit any of the steps by pressing **R.SETUP**.
- After one minute of inactivity, the remote automatically exits the operation.

Operating multiple receivers

Up to four receivers can be operated discretely using this receiver's remote control when using multiple receivers, provided they are of the same model as this receiver. The receiver to be operated is switched by inputting the preset code to set the remote control setting.

- Set the remote modes on the receivers before using this function (see *Remote Control Mode Setup* on page 119).

1 Press and hold R.SETUP, then press "4" for three seconds.

The LED flashes continuously.

- To cancel the preset setup mode press **R.SETUP**.

2 Press the number button for the receiver ("Receiver 1" to "Receiver 4") you wish to operate.

For example, to operate "Receiver 2", press "2".

If the LED lights for one second, the setting has been successfully completed.

When the preset code is input, the LED flashes three times to indicate that the setting has failed.

Setting the remote to control other components

Most components can be assigned to one of the input function buttons (such as **DVD** or **CD**) using the component's manufacturer preset code stored in the remote.

However, there are cases where only certain functions may be controllable after assigning the proper preset code, or the codes for the manufacturer in the remote control will not work for the model that you are using.

If you can't find a preset code that matches the component you want to control, you can still teach the remote individual commands from another remote control (see *Programming signals from other remote controls* on page 97).

- For greater convenience, assign the TV connected to the MONITOR OUT terminal to the **TV CTRL** button, and assign your satellite/cable receiver or set-top box connected to the TV input terminal to the **TV** input button. If a single device is connected to both terminals, that device should be assigned to both the **TV CTRL** and **TV** input buttons.
- Devices may be assigned to the following input function buttons.

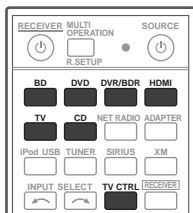

Selecting preset codes directly

1 Press and hold R.SETUP, then press "1" for three seconds.

The LED flashes continuously.

- To cancel the preset setup mode press **R.SETUP**.

2 Press the input function button for the component you want to control.

When assigning preset codes to **TV CONTROL**, press **TV CTRL** here.

The LED blinks once and flashes continuously.

3 Use the number buttons to enter the 4-digit preset code.

See *Preset code list (SC-35 only)* on page 139.

If the LED lights for one second, the setting has been successfully completed.

When the preset code is fully input, the LED flashes three times to indicate that the setting has failed. If this happens, enter the 4-digit preset code again.

4 Repeat steps 2 through 3 for the other components you want to control.

To try out the remote control, switch the component on or off (into standby) by pressing **SOURCE**. If it doesn't seem to work, select the next code from the list (if there is one).

5 Press R.SETUP to exit the preset setup mode.

Programming signals from other remote controls

If the preset code for your component is not available, or the available preset codes do not operate correctly, you can program signals from the remote control of another component. This can also be used to program additional operations (buttons not covered in the presets) after assigning a preset code.¹

Certain buttons represent operations that cannot be learned from other remote controls. The buttons available are shown below:

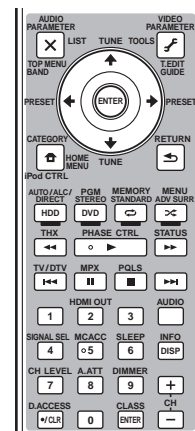
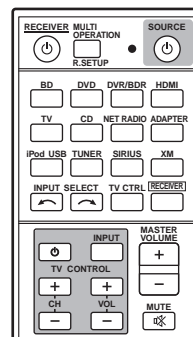

1 Press and hold R.SETUP, then press "2" for three seconds.

The LED flashes continuously.

- To cancel the preset setup mode press **R.SETUP**.

2 Press the input function button for the component you want to control.

The LED blinks once and flashes continuously.

Note

¹ The remote can store about 120 preset codes from other components (this has been tested with codes of Pioneer format only).

3 Point the two remote controls towards each other, then press the button that will be doing the learning on this receiver's remote control.

The LED blinks once and flashes continuously.

- The remote controls should be 3 cm (1 inch) apart.

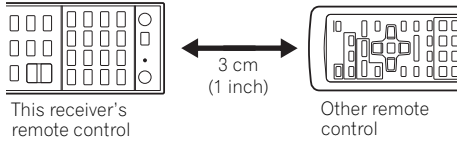

4 Press the corresponding button on the other remote control that is sending (teaching) the signal to this receiver's remote control.

If the LED lights for one second, the setting has been successfully completed.¹

5 To program additional signals for the current component repeat steps 3 and 4.

To program signals for another component, exit and repeat steps 2 through 4.

6 Press R.SETUP to exit the programming mode.

Erasing one of the remote control button settings

This erases one of the buttons you have programmed and restores the button to the factory default.

1 Press and hold R.SETUP, then press "7" for three seconds.

The LED flashes continuously.

- To cancel the preset setup mode press **R.SETUP**.

2 Press the input function button corresponding to the command to be erased, then press ENTER.

The LED flashes once.

3 Press and hold the button to be erased for three seconds.

If the LED lights for one second, the erasing has been successfully completed.

4 Repeat step 3 to erase other buttons.

5 Press R.SETUP to exit the erasing mode.

Erasing all learnt settings that are in one input function

This operation erases all the operational settings of other devices that have been programmed in one input function, and restores the factory default.

This function is handy for erasing all data programmed for devices no longer being used.

1 Press and hold R.SETUP, then press "9" for three seconds.

The LED flashes continuously.

- To cancel the preset setup mode press **R.SETUP**.

2 Press and hold the input function button corresponding to the command to be erased for three seconds.

If the LED lights for one second, the erasing has been successfully completed.

Direct function

- Default setting: **On**

You can use the direct function feature to control one component using the remote control while at the same time using your receiver to play a different component. This could let you, for example, use the remote control to set up and listen to a CD on the receiver, and then use the remote control to rewind a tape in your VCR while you continue to listen to your CD player.

When direct function is on, any component you select (using the input function buttons) will be selected by both the receiver and the remote control. When you turn direct function off, you can operate the remote control without affecting the receiver.

1 Press and hold R.SETUP, then press "5" for three seconds.

The LED flashes continuously.

- To cancel the preset setup mode press **R.SETUP**.

2 Press the input function button for the component you want to control.

3 Press "1" (On) or "0" (Off) to switch the direct function mode.

If the LED lights for one second, the setting has been successfully completed.

If the LED flashes three times, the setting has failed.

4 Press R.SETUP to exit the setup.

Note

- Note that interference from TVs or other devices will sometimes result in the remote control learning the wrong signal.
 - Some commands from other remote controls cannot be learned, but in most cases the remotes just need to be moved closer together or farther apart.
 - If the LED flashes for five seconds, it means the memory is full. See *Erasing all learnt settings that are in one input function* on page 98 to erase a programmed button you're not using to free up more memory (note that some signals may take more memory than others).

Setting the backlight mode

- Default setting: **1 (normal mode)**

The backlight lighting pattern can be selected from among four modes, in consideration of convenience and battery service life.

1 Press and hold R.SETUP, then press "6" for three seconds.

The LED flashes continuously.

- To cancel the preset setup mode press **R.SETUP**.

2 Press the number button for the backlight mode you want to set.

- **"1" (normal mode)** – The backlight is turned on and off with the light button. After it lights, it turns off automatically if no operation is performed for 10 seconds.
- **"2" (frequent lighting mode)** – The backlight turns on when any button on the remote control is pressed. It is turned off with the light button. After it lights, it turns off automatically if no operation is performed for 10 seconds.
- **"3" (eco mode)** – The backlight is turned on and off with the light button. After it lights, it turns off automatically if no operation is performed for 5 seconds.
- **"4" (off mode)** – The backlight does not turn on even when the light button is pressed.

If the LED lights for one second, the setting has been successfully completed.

If the LED flashes three, the setting has failed.

3 Press R.SETUP to exit the setup.

Multi operation and System off

The Multi operation feature allows you to program a series of up to 5 commands for the components in your system.

- Be sure to call up the preset codes of devices or perform programming signals for other remote controls before multi operation memory programming (page 97).

The Multi operation feature makes it easy to perform the following operations by pressing just two buttons.

Press **MULTI OPERATION** and then the **DVD** input function button to:

1. Switch this receiver on.
2. Switch this receiver's input to DVD.
3. Transmit a sequence of up to five programmed commands.

Similar to Multi operations, System off allows you to use two buttons to stop and switch off a series of components in your system at the same time.¹ Only one System off operation sequence may be programmed.

Press **MULTI OPERATION** and then **⏻ SOURCE** to:

1. Transmit a sequence of up to five programmed commands.
2. Switch off all Pioneer devices including the receiver (except DVD recorders and VCRs).

For greater convenience, program this receiver to perform power on/off and playback operations on non-Pioneer devices as well.² (The signals for Pioneer devices described above are not contingent on programming for non-Pioneer devices.)

The buttons that can be programmed using Multi operation or System off are the same buttons as those that can be programmed for other remote controls (see *Programming signals from other remote controls* on page 97).

Note

- 1 • Before Multi operation and System off will work correctly, you must setup the remote to work with your TV and other components (see *Setting the remote to control other components* on page 97 for more on this).
 - Some units may take some time to power up, in which case multiple operations may not be possible.
 - Power on and off commands only work with components that have a standby mode.
- 2 Some remote controllers for other manufacturers' devices use the same signals for switching the power on and off. In some cases, even if this receiver is programmed to perform these commands, power to the non-Pioneer devices may not be switched on and off correctly. Program the receiver to perform these commands if the non-Pioneer device uses separate signals for power on/off.

Programming a Multi operation or a shutdown sequence

1 Press and hold R.SETUP, then press "3" for three seconds.

The LED flashes continuously.

- To cancel the preset setup mode press **R.SETUP**.

2 Press the input function button (or \odot SOURCE button).

For *Multi operations*, press the input function you wish to program (for example, if you want to start the sequence by switching on your DVD player, press **DVD**).¹

For *System off*, press the \odot **SOURCE** button.

The LED blinks twice and flashes continuously.

3 If necessary, press the input function button for the component whose command you want to input.

This is only necessary if the command is for a new component (input function).

4 Select the button for the command you want to input.

The LED blinks once and flashes continuously.

- You don't need to program the receiver to switch on or off. This is done automatically.

With Pioneer components, you don't need to program the power to switch off in a shutdown sequence (except DVD recorders).

5 Repeat steps 3 to 4 to program a sequence of up to five commands.

If you press **R.SETUP** before programming is completed, commands programmed up to that point will be stored.

6 Press R.SETUP to exit the programming mode.

Using multi operations

1 Press MULTI OPERATION.

The LED flashes continuously.

2 Within five seconds, press an input function button that has been set up with a multi operation.

The receiver switches on (if it was in standby) and the programmed multi operation is performed automatically.

Using System off

1 Press MULTI OPERATION.

The LED flashes continuously.

2 Within five seconds, press \odot SOURCE.

The command sequence you programmed will run, then all Pioneer components will switch off², followed by this receiver (switch of all the zones becomes off).

Erasing the settings for the multi-operation

This erases all the settings programmed in the remote control for the multi-operation.

1 Press and hold R.SETUP, then press "8" for three seconds.

The LED flashes continuously.

- To cancel the preset setup mode press **R.SETUP**.

2 Press the input function button containing the program you want to cancel or the \odot SOURCE button for three seconds.

If the LED lights for one second, the erasing has been successfully completed.

Note

¹ With Multi operation, the **HDMI** and **TV CTRL** settings cannot be made. For other settable input functions, see *Setting the remote to control other components* on page 97.

² In order to avoid accidentally switching off a DVD recorder that is currently recording, no DVD recorder power off codes are sent.

Resetting the remote control settings

Use this procedure to reset all the remote control's settings to the factory default.¹

1 Press and hold R.SETUP, then press "0" for three seconds.

The LED flashes continuously.

2 Press and hold the ENTER button for three seconds.

If the LED lights for one second, the erasing has been successfully completed.

Default preset codes

Input function button	Preset code
DVD	2 1 5 8
BD	2 1 6 0
DVR/BDR	2 1 5 0
HDMI	2 1 5 9
TV	0 1 1 6
CD	5 0 6 6
TV CTRL	0 1 1 6

Controlling components

This remote control can control components after entering the proper codes (see *Setting the remote to control other components* on page 97 for more on this). Use the input function buttons to select the component.

- The **TV CONTROL** buttons on the remote control are dedicated to control the TV assigned to the **TV CTRL** button. If you have two TVs, assign the main TV to the **TV CTRL** button.

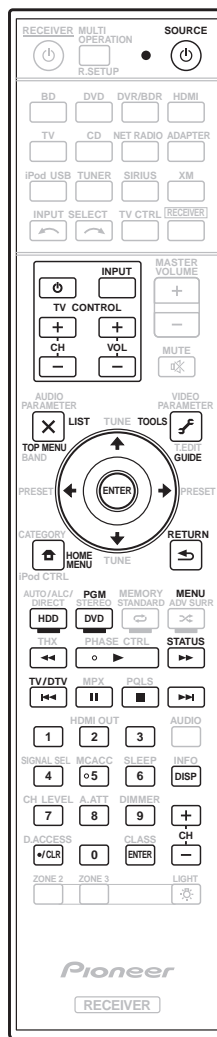

Note

¹ When preset codes are set, all the signals learned in the input function buttons are cleared. This function is convenient when you want to reset some but not all of input function buttons.

Button(s)	TV	TV (Monitor)	BD/DVD	HDD/DVR	VCR	SAT/CATV
SOURCE	POWER ON/OFF	POWER ON/OFF	POWER ON/OFF	POWER ON/OFF	POWER ON/OFF	POWER ON/OFF
Number buttons	<i>numerics</i>	<i>numerics</i>	<i>numerics</i>	<i>numerics</i>	<i>numerics</i>	<i>numerics</i>
• (dot)	• (dot)	KURO LINK	CLEAR	+	-	*
ENTER (CLASS)	ENTER	CH ENTER	ENTER	ENTER	-	ENTER
	EXIT/INFO	EXIT	TOP MENU	TOP MENU	-	LIST
	TOOLS/GUIDE/ EPG	USER MENU	TOOLS	GUIDE	-	GUIDE
					-	
ENTER	ENTER	ENTER	ENTER	ENTER	-	ENTER
	HOME MENU	HOME MENU	HOME MENU	HOME MENU	-	HOME / MENU
	RETURN	RETURN	RETURN	RETURN	-	RETURN
HDD (Red)	<i>Red</i>	<i>Red</i>	-	HDD	-	<i>Red</i>
DVD (Green)	<i>Green</i>	<i>Green</i>	-	DVD	-	<i>Green</i>
(Yellow)	<i>Yellow</i>	<i>Yellow</i>	-	VCR	-	<i>Yellow</i>
(Blue)	<i>Blue</i>	<i>Blue</i>	MENU	MENU	-	<i>Blue</i>
	-	-				
	-	AUTO SETUP				
	-	FREEZE				
	-	-				
	-	-				
	ANT	AV SELECTION			-	
	-	SCREEN SIZE			-	
AUDIO	AUDIO	AUDIO	AUDIO	AUDIO	AUDIO	AUDIO
DISP	DISPLAY	DISPLAY	DISPLAY	DISPLAY	-	DISPLAY/INFO
CH +/-	CH+/-	CH+/-	OUTPUT RESOLUTION +/- ^a	CH+/-	CH+/-	CH+/-

a. Controls for BD.

Button(s)	LD	CD/CD-R/SACD	MD/DAT	TAPE
SOURCE	POWER ON/OFF	POWER ON/OFF	POWER ON/OFF	POWER ON/OFF
Number buttons	<i>numerics</i>	<i>numerics</i>	<i>numerics</i>	-
• (dot)	+10	>10/CLEAR	CLEAR ^b	CLEAR
ENTER (CLASS)	ENTER	DISK/ENTER	OPEN/CLOSE ^b	ENTER
	TOP MENU	-	-	MS←
	-	LEGATO LINK ^a	-	MS→
		-	-	
ENTER	ENTER	-	-	-
	-	SACD SETUP ^a	-	-
	RETURN	-	-	-
AUDIO	AUDIO	PURE AUDIO ^a	-	-
DISP	DISPLAY/INFO	TIME ^a	-	-

a. Controls for SACD.
b. Controls for MD.

Button(s)	TV (Projector)
SOURCE	POWER ON
1	MOVIE
2	STANDARD
3	DYNAMIC
4	USER1
5	USER2
6	USER3
7	COLOR+
8	SHARP+
9	GAMMA
0	COLOR-
• (dot)	SHARP-
ENTER (CLASS)	COLOR TEMP
	EXIT
	INFO
ENTER	ENTER
	TEST
	HIDE
	MENU
	HDMI1
	HDMI2
	COMP.
	VIDEO
	S-VIDEO
	BRIGHT-
	BRIGHT+
AUDIO	POWER OFF
DISP	ASPECT
CH +/-	CONTRAST+/-

Chapter 11:

The Advanced MCACC menu

**Important**

- The procedure for setting the receiver operation mode differs for the remote controls included with the SC-37 and SC-35. For the SC-37's remote control, set the remote control operation selector switch to **RECEIVER**. For the SC-35's remote control, press the **RECEIVER** button. When "set the remote control to the receiver operation mode" is indicated in these instructions, use the respective procedure described above.

Making receiver settings from the Advanced MCACC menu

The Advanced MCACC (Multi Channel ACoustic Calibration) system was developed in Pioneer's laboratories with the aim of making it possible for home users to perform adjustments of the same level as in a studio easily and with high precision. The acoustic characteristics of the listening environment are measured and the frequency response is calibrated accordingly to allow high precision, automatic analysis and optimal calibration of the sound field to bring it closer to a studio environment than ever before. Furthermore, while it was previously difficult to eliminate standing waves, this receiver is equipped with a standing wave control function using a unique process to perform acoustic analysis and reduce their influence.

This section describes how to calibrate the sound field automatically and fine-adjust the sound field data manually.

1 Switch on the receiver and your TV.

Make sure that the TV's video input is set to this receiver.

2 Set the remote control to the receiver operation mode, then press HOME MENU.

A Graphical User Interface (GUI) screen appears on your TV. Use **↑/↓/←/→** and **ENTER** to navigate through the screens and select menu items. Press **RETURN** to confirm and exit the current menu.

- Press **HOME MENU** at any time to exit the **Home Menu**.

3 Select 'Advanced MCACC' from the Home Menu, then press ENTER.

4 Select the setting you want to adjust.

- **Full Auto MCACC** – See *Automatically conducting optimum sound tuning (Full Auto MCACC)* on page 43 for a quick and effective automatic surround setup.

- **Auto MCACC** – See *Automatic MCACC (Expert)* below for a more detailed MCACC setup. *SC-37 only:* In addition, the Full Band Phase Control function calibrates the frequency-phase characteristics of the connected speakers.
- **Manual MCACC** – Fine-tunes your speaker settings and customizes the Acoustic Calibration EQ (see *Manual MCACC setup* on page 106).
- **Demo** – No settings are saved and no errors occur. When the speakers are connected to this receiver, the test tone is output repeatedly. Press **RETURN** to cancel the test tone.

Automatic MCACC (Expert)

If your setup requires more detailed settings than those provided in *Automatically conducting optimum sound tuning (Full Auto MCACC)* on page 43, you can customize your setup options below. You can calibrate your system differently for up to six different MCACC presets, which are useful if you have different listening positions depending on the type of source (for example, watching movies from a sofa, or playing a video game close to the TV).

**Important**

- Make sure the microphone/speakers are not moved during the Auto MCACC Setup.
- The screen saver will automatically appear after five minutes of inactivity.

**CAUTION**

- The test tones used in the Auto MCACC Setup are output at high volume.

THX®

THX is a trademark of THX Ltd., which may be registered in some jurisdictions. All rights reserved.

1 Select 'Auto MCACC' from the Advanced MCACC menu, then press ENTER.

If the **Advanced MCACC** screen is not displayed, refer to *Making receiver settings from the Advanced MCACC menu* above.

2 Select the parameters you want to set.

Use **↑/↓** to select the item, then use **←/→** to set.

- **Auto MCACC** – The default is **ALL** (recommended), but you can limit the system calibration to only one setting (to save time) if you want.¹
- **EQ Type** (only available when the **Auto MCACC Menu** above is **EQ Pro & S-Wave**) – This determines how the frequency balance is adjusted.

After a single calibration is performed, each of the following three correction curves can be stored separately in the MCACC memory. **SYMMETRY** implements symmetric correction for each pair of left and right speakers to flatten the frequency-amplitude characteristics. **ALL CH ADJ** is a 'flat' setting where all the speakers are set individually so no special weighting is given to any one channel. **FRONT ALIGN**² sets all speakers in accordance with the front speaker settings (no equalization is applied to the front left and right channels).

- **THX Speaker** (only available when the **Auto MCACC Menu** above is **ALL** or **Speaker Setting**) – Select **YES** if you are using THX speakers (set all speakers to **SMALL**), otherwise leave it set to **NO**.
- **STAND.WAVE Multi-Point** (only available when the **Auto MCACC Menu** above is **EQ Pro & S-Wave**) – In addition to measurements at the listening position, you can use two more reference points for which test tones will be analyzed for standing waves. This is useful if you want to get a balanced 'flat' calibration for several seating positions in your listening area. Place the microphone at the reference point indicated on-screen and note that *the last microphone placement will be at your main listening position*:

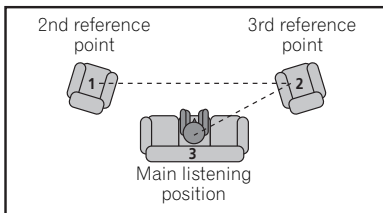

3 Connect the microphone to the MCACC SETUP MIC jack on the front panel.

Make sure there are no obstacles between the speakers and the microphone.

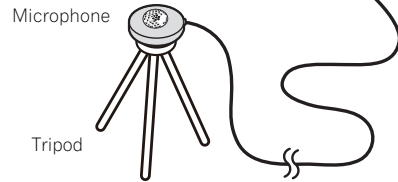
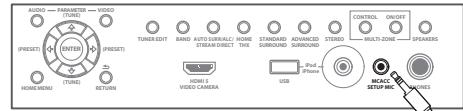

If you have a tripod, use it to place the microphone so that it's about ear level at your normal listening position. If you do not have a tripod, use some other object to install the microphone.³

4 When you're finished setting the options, select **START** then press **ENTER**.

5 Follow the instructions on-screen.

6 Wait for the Auto MCACC Setup to finish outputting test tones.

A progress report is displayed on-screen while the receiver outputs test tones to determine the speakers present in your setup. Try to be as quiet as possible while it's doing this.⁴

- With error messages (such as **Too much ambient noise!** or **Check microphone**) select **RETRY** after checking for ambient noise (see *Problems when using the Auto MCACC Setup* on page 45) and verifying the mic connection. If there doesn't seem to be a problem, you can simply select **GO NEXT** and continue.

7 If necessary, confirm the speaker configuration in the GUI screen.

The configuration shown on-screen should reflect the actual speakers you have.

Note

- When data measurement is taken (after selecting **ALL** or **Keep SP System**), the reverb characteristics data (both before- and after-calibration) that this receiver had been storing will be overwritten. If you want to save the reverb characteristics data before measuring, connect a USB memory device to this receiver and transfer the data.
 - When measurement is taken of data other than **SYMMETRY** (after selecting **ALL** or **Keep SP System**), the data are not measured after the correction. If you will need to measure after correction data, take the measurement using the EQ Professional menu in the Manual MCACC setup (page 106).
 - The **EQ Pro & S-Wave** measurement is also taken when **Keep SP System** or **EQ Pro & S-Wave** is selected. See *Acoustic Calibration EQ Professional* on page 108 for more on this.
 - Either effect of Acoustic Calibration EQ Professional and Standing Wave can be switched on and off in the respective MCACC preset. For details, see *Setting the Audio options* on page 76.
- 2 If you selected **ALL** or **Keep SP System** as your **Auto MCACC** menu, you can specify the MCACC preset where you want to save the **SYMMETRY**, **ALL CH ADJ** and **FRONT ALIGN** settings.
- 3 It may not be possible to measure correctly if the microphone is placed on a table, sofa, etc.
- 4 Do not adjust the volume during the test tones. This may result in incorrect speaker settings.

If no operations are performed for 10 seconds while the speaker configuration check screen is being displayed, the Auto MCACC Setup will resume automatically. In this case, you don't need to select **'OK'** and press **ENTER** in step 8.

- If you see an **ERR** message (or the speaker configuration displayed isn't correct), there may be a problem with the speaker connection. If selecting **RETRY** doesn't work, turn off the power and check the speaker connections. If there doesn't seem to be a problem, you can simply use **↑/↓** to select the speaker and **←/→** to change the setting and continue.
- If **Reverse Phase** is displayed, the speaker's wiring (+ and -) may be inverted. Check the speaker connections.¹
 - If the connections were wrong, turn off the power, disconnect the power cord, then reconnect properly. After this, perform the Full Auto MCACC procedure again.
 - If the connections were right, select **GO NEXT** and continue.

8 Make sure 'OK' is selected, then press ENTER.

A progress report is displayed on-screen while the receiver outputs more test tones to determine the optimum receiver settings.

Again, try to be as quiet as possible while this is happening. It may take 3 to 7 minutes.

- If you selected a **STAND.WAVE Multi-Point** setup (in step 2), you will be asked to place the mic at the 2nd and 3rd reference points before finally placing it at your main listening position.

9 The Auto MCACC Setup procedure is completed and the Advanced MCACC menu reappears automatically.

The settings made in the Auto MCACC Setup should give you excellent surround sound from your system, but it is also possible to adjust these settings manually using the **Manual MCACC** setup menu (starting below) or **Manual SP Setup** menu (starting on page 114).²

You can also choose to view the settings by selecting individual parameters from the **MCACC Data Check** screen (see *Checking MCACC Data* on page 110).

Press **RETURN** after you have finished checking each screen. When you're finished, select **RETURN** to go back to the **Home Menu**.

Be sure to disconnect the microphone from this receiver upon completion of the Auto MCACC Setup.

Note

- 1 If the speaker is not pointed to the microphone (listening position) or when using speakers that affect the phase (dipole speakers, reflective speakers, etc.), **Reverse Phase** may be displayed even if the speakers are properly connected.
- 2 Depending on the characteristics of your room, sometimes identical speakers with cone sizes of around 12 cm (5 inches) will end up with different size settings. You can correct the setting manually using the *Manual speaker setup* on page 114.
 - The subwoofer distance setting may be farther than the actual distance from the listening position. This setting should be accurate (taking delay and room characteristics into account) and generally does not need to be changed.
 - If Auto MCACC Setup measurement results are incorrect due to the interaction of the speakers and viewing environment, we recommend adjusting the settings manually.

Manual MCACC setup

You can use the settings in the **Manual MCACC** setup menu to make detailed adjustments when you're more familiar with the system. Before making these settings, you should have already completed *Automatically conducting optimum sound tuning (Full Auto MCACC)* on page 43.

You only need to make these settings once (unless you change the placement of your current speaker system or add new speakers).

CAUTION

- The test tones used in the **Manual MCACC** setup are output at high volume.

Important

- Press the **MCACC** button while the pertinent setup screens are displayed to select MCACC presets.
- For some of the settings below, you'll have to connect the setup microphone to the front panel and place it about ear level at your normal listening position. Press **HOME MENU** to display the **Home Menu** before you connect the microphone to this receiver.
- See *Problems when using the Auto MCACC Setup* on page 45 for notes regarding high background noise levels and other possible interference.
- If you're using a subwoofer, switch it on and turn up the volume to the middle position.

1 Select 'Manual MCACC' from the Advanced MCACC menu.

See *Making receiver settings from the Advanced MCACC menu* on page 104 if you're not already at this screen.

2 Select the setting you want to adjust.

If you're doing this for the first time, you might want to make these settings in order.

- **Fine Channel Level** – Make fine adjustments to the overall balance of your speaker system (see *Fine Channel Level* on page 107).
- **Fine SP Distance** – Make precise delay settings for your speaker system (see *Fine Speaker Distance* on page 107).

- **Standing Wave** – Control overly resonant low frequencies in your listening room (see *Standing Wave* on page 107).

The last two settings are specifically for customizing the parameters explained in *Acoustic Calibration EQ Adjust* on page 108:

- **EQ Adjust** – Manually adjust the frequency balance of your speaker system while listening to test tones (see *Acoustic Calibration EQ Adjust* on page 108).
- **EQ Professional** – Calibrate your system based on the direct sound coming from the speakers and make detailed settings according to your room's reverb characteristics (see *Acoustic Calibration EQ Professional* on page 108).
- **Precision Distance (SC-37 only)** – Fine-adjusting the positions of the speakers (see *Precision Distance (SC-37 only)* on page 110).

Fine Channel Level

- Default setting: **0.0dB** (all channels)

You can achieve better surround sound by properly adjusting the overall balance of your speaker system. You can adjust the Channel Level of each speaker in 0.5 dB increments. The following setting can help you make detailed adjustments that you may not achieve using the *Manual speaker setup* on page 114.

1 Select 'Fine Channel Level' from the Manual MCACC setup menu.

The volume increases to the 0.0 dB reference level.

2 Adjust the level of the left channel.

This will be the reference speaker level, so you may want to keep the level around **0.0dB** so that you'll have plenty of room to adjust the other speaker levels.

- After pressing **ENTER**, test tones will be output.

3 Select each channel in turn and adjust the levels (+/-12.0 dB) as necessary.

Use **←/→** to adjust the volume of the speaker you selected to match the reference speaker. When it sounds like both tones are the same volume, press **↓** to confirm and continue to the next channel.

- For comparison purposes, the reference speaker will change depending on which speaker you select.
- If you want to go back and adjust a channel, simply use **↑/↓** to select it.

4 When you're finished, press RETURN.

You will return to the **Manual MCACC** setup menu.

Fine Speaker Distance

- Default setting: **10'00"** (all speakers)

For proper sound depth and separation with your system, it is necessary to add a slight bit of delay to some speakers so that all sounds will arrive at the listening position at the same time. You can adjust the distance of each speaker in half inch increments. The following setting can help you make detailed adjustments that you may not achieve using the *Manual speaker setup* on page 114.

1 Select 'Fine SP Distance' from the Manual MCACC setup menu.

2 Adjust the distance of the left channel from the listening position.

3 Select each channel in turn and adjust the distance as necessary.

Use **←/→** to adjust the delay of the speaker you selected to match the reference speaker.

Listen to the reference speaker and use it to measure the target channel. From the listening position, face the two speakers with your arms outstretched pointing at each speaker. Try to make the two tones sound as if they are arriving simultaneously at a position slightly in front of you and between your arm span.¹

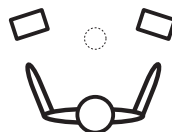

When it sounds like the delay settings are matched up, press **↓** to confirm and continue to the next channel.

- For comparison purposes, the reference speaker will change depending on which speaker you select.
- If you want to go back and adjust a channel, simply use **↑/↓** to select it.

4 When you're finished, press RETURN.

You will return to the **Manual MCACC** setup menu.

Standing Wave

- Default setting: **ON²/ATT 0.0dB** (all filters)

Acoustic standing waves occur when, under certain conditions, sound waves from your speaker system resonate mutually with sound waves reflected off the walls in your listening area. This can have a negative effect on the overall sound, especially at certain lower frequencies. Depending on speaker placement, your listening position, and ultimately the shape of your room,

Note

- If you can't seem to achieve this by adjusting the distance setting, you may need to change the angle of your speakers very slightly.
 - For better audibility, the subwoofer emits a continuous test tone (oscillating pulses are heard from your other speakers). Note that it may be difficult to compare this tone with the other speakers in your setup (depending on the low frequency response of the reference speaker).
- 2 You can switch on or off the Standing Wave and Acoustic Calibration EQ feature in the **AUDIO PARAMETER** menu. See *Setting the Audio options* on page 76 for more on this.

it results in an overly resonant ('boomy') sound. The Standing Wave Control uses filters to reduce the effect of overly resonant sounds in your listening area. During playback of a source, you can customize the filters used for Standing Wave Control for each of your MCACC presets.¹

1 Select 'Standing Wave' from the Manual MCACC setup menu.

2 Adjust the parameters for the Standing Wave Control.

- **Filter Channel** – Select the channel to which you will apply the filter(s): **MAIN** (all except center channel and subwoofer), **Center** or **SW** (subwoofer).
- **TRIM** (*only available when the filter channel above is SW*) – Adjust the subwoofer channel level (to compensate for the difference in output post-filter).
- **Freq/ Q/ ATT** – These are the filter parameters where **Freq** represents the frequency you will be targeting and **Q** is the bandwidth (the higher the Q, the narrower the bandwidth, or range) of the attenuation (**ATT**, the amount of reduction to the targeted frequency).

3 When you're finished, press RETURN.

You will return to the **Manual MCACC** setup menu.

Acoustic Calibration EQ Adjust

- Default setting: **ON/0.0dB** (all channels/bands)

Acoustic Calibration Equalization is a kind of room equalizer for your speakers (excluding the subwoofer). It works by measuring the acoustic characteristics of your room and neutralizing the ambient characteristics that can color the original source material (providing a 'flat' equalization setting). If you're not satisfied with the adjustment provided in *Automatically conducting optimum sound tuning (Full Auto MCACC)* on page 43 or *Automatic MCACC (Expert)* on page 104, you can also adjust these settings manually to get a frequency balance that suits your tastes.

1 Select 'EQ Adjust' from the Manual MCACC setup menu.

2 Select the channel(s) you want and adjust to your liking.

Use **↑/↓** to select the channel.

Use **←/→** to select the frequency and **↑/↓** to boost or cut the EQ. When you're finished, go back to the top of the screen and press **←** to return to **Ch**, then use **↑/↓** to select the channel.

- The **OVER!** indicator shows in the display if the frequency adjustment is too drastic and might distort. If this happens, bring the level down until **OVER!** disappears from the display.



Tip

- Changing the frequency curve of one channel too drastically will affect the overall balance. If the speaker balance seems uneven, you can raise or lower channel levels using test tones with the **TRIM** feature. Use **↑/↓** to select **TRIM**, then use **←/→** to raise or lower the channel level for the current speaker.

3 When you're finished, press RETURN.

You will return to the **Manual MCACC** setup menu.

Acoustic Calibration EQ Professional

This setup minimizes the unwanted effects of room reverberation by allowing you to calibrate your system based on the direct sound coming from the speakers.

How to use Acoustic Calibration EQ Professional

If you find that lower frequencies seem overly reverberant in your listening room (i.e. it sounds 'boomy'), or that different channels seem to exhibit different reverb characteristics (when Type A or Type B shown on the diagrams on the following applies), select **EQ Pro. & S-Wave** (or **ALL**) for the **Auto MCACC** setting in *Automatic MCACC (Expert)* on page 104 to calibrate the room automatically.

- **Type A: Reverberance of high vs. low frequencies**

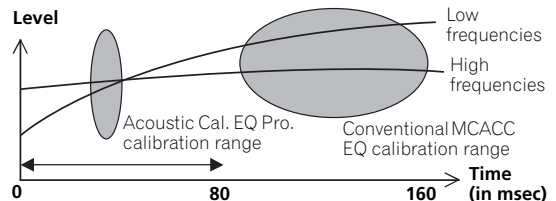

- **Type B: Reverb characteristics for different channels**

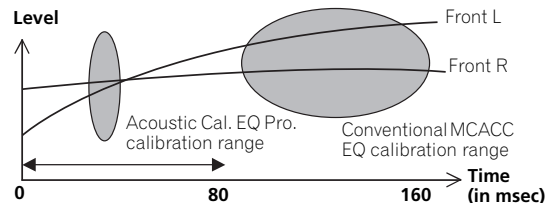

If the pattern is as shown above, select the **30-50ms** setting. If not, this setting is not necessary.

Note

¹ Standing Wave control filter settings cannot be changed during playback of sources using the HDMI connection.

Using Acoustic Calibration EQ Professional

1 Select 'EQ Professional', then press ENTER.

2 Select an option and press ENTER.

- **Reverb Measurement** – Use this to measure the reverb characteristics before and after calibration.
- **Reverb View** – You can check the reverb measurements made for specified frequency ranges in each channel.¹
- **Advanced EQ Setup** – Use this to select the time period that will be used for frequency adjustment and calibration, based on the reverb measurement of your listening area. Note that customizing system calibration using this setup will alter the settings you made in *Automatically conducting optimum sound tuning (Full Auto MCACC)* on page 43 or *Automatic MCACC (Expert)* on page 104 and is not necessary if you're satisfied with these settings.

3 If you selected 'Reverb Measurement', select EQ ON or OFF, and then START.

The following options determine how the reverb characteristics of your listening area are displayed in **Reverb View**:

- **EQ OFF** – You will see the reverb characteristics of your listening area *without* the equalization performed by this receiver (before calibration).
- **EQ ON** – You will see the reverb characteristics of your listening area *with* the equalization performed by this receiver (after calibration).² Note that the EQ response may not appear entirely flat due to adjustments necessary for your listening area.³

When the reverb measurement is finished, you can select **Reverb View** to see the results on-screen. See *Professional Calibration EQ graphical output* on page 127 for troubleshooting information.

4 If you selected 'Reverb View', you can check the reverb characteristics for each channel. Press RETURN when you're done.

The reverb characteristics are displayed when the **Full Auto MCACC** or **Reverb Measurement** measurements are conducted.⁴

Use ←/→ to select the channel, frequency and calibration setting you want to check. Use ↑/↓ to go back and forth between the three. The reverb characteristics graph before and after EQ calibration can be displayed by selecting **Calibration : Before / After**. Note that the markers on the vertical axis indicate decibels in 2 dB steps.

5 If 'Advanced EQ Setup' is selected, select the MCACC memory to be stored, then enter the desired time setting for calibration, and then select START.⁵

Based on the reverb measurement above, you can choose the time period that will be used for the final frequency adjustment and calibration. Even though you can make this setting without reverb measurement, it is best to use the measurement results as a reference for your time setting. For an optimal system calibration based on the direct sound coming from the speakers, we recommend using the **30-50ms** setting.

Use ←/→ to select the setting. Use ↑/↓ to switch between them.

Select the setting from the following time periods (in milliseconds): **0-20ms, 10-30ms, 20-40ms, 30-50ms, 40-60ms, 50-70ms** and **60-80ms**. This setting will be applied to all channels during calibration.

When you're finished, select **START**. It will take about 2 to 4 minutes for the calibration to finish.

After the Acoustic Calibration Equalization is set, you are given the option to check the settings on-screen.

Note

1 If the **Reverb View** procedure is performed after the *Automatically conducting optimum sound tuning (Full Auto MCACC)* on page 43 or **Reverb Measurement** operation, depending on the standing wave control setting, differences may appear on the reverb graph. With the Auto MCACC function, the reverberations are measured with the standing waves controlled, so the reverb characteristics graph shows the characteristics with the effect of the standing waves eliminated. By contrast, the **Reverb Measurement** function measures the reverberations without controlling the standing waves, so the graph indicates the reverb characteristics including the effect of the standing waves. If you wish to check the reverb characteristics of the room itself (with the standing waves as such), we recommend using the **Reverb Measurement** function.

2 • The calibration corresponding to the currently selected MCACC preset will be used when **EQ ON** is selected. To use another MCACC preset, press **MCACC** to select the MCACC memory you want to store.
 • The predicted reverb characteristics after calibration can be acquired with the **Full Auto MCACC** function (*Automatically conducting optimum sound tuning (Full Auto MCACC)* on page 43), but here the actually measured reverb characteristics after calibration can be acquired.

3 After auto calibration with **EQ Type : SYMMETRY (Full Auto MCACC, etc.)**, the graph for the inferred reverb characteristics can be displayed by selecting **Reverb View**. To display the actually measured reverb characteristics after EQ calibration, measure with **EQ ON**.

4 The **After** display when measurements have been made using the **Full Auto MCACC** or **Auto MCACC (ALL or KEEP SP system)** function shows the graph for the inferred reverb characteristics after **EQ Type : SYMMETRY** calibration.

5 To specify the place where the MCACC memory is to be stored, press **MCACC** to select the MCACC memory you want to store.

Precision Distance (SC-37 only)

Before using this function, perform the Full Auto MCACC Setup procedure (see page 43). Performing the Full Auto MCACC procedure corrects the distance to a precision of $\frac{1}{2}$ inch, but the Precision Distance function lets you adjust the distance to the speakers (their position) with a precision of under $\frac{1}{2}$ inch. Here, rather than correct the numerical value of the distance, actually move the physical positions of the speakers to fine-adjust (the subwoofer cannot be adjusted). The input from the microphone is indicated on the screen. Fine-adjust the positions of the speakers so that the gauge reading is maximum. The detailed distance adjustments that were previously performed by skilled installers by ear can easily be performed watching the gauge on the monitor. Place the microphone in the same position as when the microphone was connected and the Full Auto MCACC operation was performed.

1 Select 'Precision Distance' from the Manual MCACC setup menu.

2 Fine-adjust the positions of the speakers in sequence, starting from the front right channel.¹

Test pulses are output from the speaker for the selected channel and from one other speaker. Move the position of the selected speaker $\frac{1}{2}$ inch towards or away from the microphone. Watch the screen when doing so, and fine-adjust the positions of the speakers so that the gauge reading is maximum. Also, the channel serving as the standard differs according to the channel being adjusted. Do not move the speaker serving as the standard channel.

The maximum gauge reading is 10.0. (If the reading stays under 10.0, adjust the speaker for the maximum value.)

3 When you're finished, press RETURN.

You will return to the Manual MCACC setup menu.

Checking MCACC Data

At the procedure of *Automatically conducting optimum sound tuning (Full Auto MCACC)* on page 43, the procedure of *Automatic MCACC (Expert)* on page 104 or after fine-adjusting at *Manual MCACC setup* on page 106, you can check your calibrated settings using the GUI screen. The data can be transferred to a computer using a USB device to check it on the computer's screen as well.

1 Set the remote control to the receiver operation mode, then press HOME MENU.

A Graphical User Interface (GUI) screen appears on your TV. Use $\uparrow/\downarrow/\leftarrow/\rightarrow$ and **ENTER** to navigate through the screens and select menu items. Press **RETURN** to confirm and exit the current menu.

2 Select 'MCACC Data Check' from the Home Menu.

3 Select the setting you want to check.

- **Speaker Setting** – Used to check the settings of the speaker systems. See *Speaker Setting* on page 111 for more on this.
- **Channel Level** – Used to check the output level of the different speakers. See *Channel Level* on page 111 for more on this.
- **Speaker Distance** – Used to check the distance to the different speakers. See *Speaker Distance* on page 111 for more on this.
- **Standing Wave** – Used to check the standing wave control filter settings. See *Standing Wave* on page 111 for more on this.
- **Acoustic Cal EQ** – Used to check the calibration values of the listening environment's frequency response. See *Acoustic Cal EQ* on page 111 for more on this.
- **Group Delay (SC-37 only)** – Used to check the speakers' group delay (both before and after calibration). See *Group Delay (SC-37 only)* on page 111 for more on this.
- **Output MCACC data** – See *Output MCACC data* on page 112 for more on this.

Note

¹ • If the microphone is placed in a different position from when the Auto MCACC procedure was performed, it may not be possible to adjust properly. In this case, we recommend performing the procedure at *Fine Speaker Distance* on page 107 in the Auto MCACC custom measurements, then performing the adjustment described here without moving the microphone.

- The adjustment here is for adjusting for an error of $\frac{1}{2}$ inch or less (not adjustable with the Auto MCACC Setup). 0.0 may be displayed after distance correction with the Auto MCACC Setup, but even in this case this adjustment allows you to optimize the correction. Note that if the Auto MCACC Setup is performed after completing the fine-adjustment here, the correction precision will drop to about $\frac{1}{2}$ inch.
- Like with the Auto MCACC Setup, perform this adjustment in as quiet an environment as possible. 0.0 will be displayed if abrupt noise is input during the adjustment.
- The distance for all the channels can only be made uniform even if the **R** (front right) channel is adjusted in the proper order.
- Be very careful not to tip the speakers over when moving them.
- The result of the adjustment performed here can be checked by listening to the test pulses output at the *Precision Distance (SC-37 only)* (the test pulses will be more centrally positioned between the speakers than before the adjustment was performed). Be careful not to change the distance values at this time.

4 Press RETURN to go back to the MCACC Data Check menu, repeating steps 2 and 3 to check other settings.

5 When you're finished, press RETURN. You will return to the Home Menu.

Speaker Setting

Use this to display the speaker size and number of speakers. See *Speaker Setting* on page 115 for more on this.

1 Select 'Speaker Setting' from the MCACC Data Check menu.

2 Select the channel you want to check.

Use ↑/↓ to select the channel. The corresponding channel on the layout diagram is highlighted.

Channel Level

Use this to display the level of the various channels. See *Channel Level* on page 116 for more on this.

1 Select 'Channel Level' from the MCACC Data Check menu.

2 When 'MCACC' is highlighted, use ←/→ to select the MCACC preset you want to check.

The level of the various channels set at the selected MCACC preset is displayed. '---' is displayed for channels that are not connected.

Speaker Distance

Use this to display the distance from the different channels to the listening position. See *Speaker Distance* on page 116 for more on this.

1 Select 'Speaker Distance' from the MCACC Data Check menu.

2 When 'MCACC' is highlighted, use ←/→ to select the MCACC preset you want to check.

The distance from the various channels set at the selected MCACC preset is displayed. '---' is displayed for channels that are not connected.

Standing Wave

Use this to display the standing wave related adjustment values for the various MCACC memories. See *Standing Wave* on page 107 for more on this.

1 Select 'Standing Wave' from the MCACC Data Check menu.

2 When 'Filter Channel' is highlighted, use ↑/↓ to select the channel for which you want to check standing wave control.

The standing wave related calibration value for the selected channel stored at the selected MCACC preset and its graph are displayed.

3 Press ← to highlight 'MCACC', then use ↑/↓ to select the MCACC preset you want to check.

Acoustic Cal EQ

Use this to display the calibration values for the frequency response of the various channels set in the different MCACC presets. See *Acoustic Calibration EQ Adjust* on page 108 for more on this.

1 Select 'Acoustic Cal EQ' from the MCACC Data Check menu.

2 When 'Ch' is highlighted, use ↑/↓ to select the channel.

The calibration value for the frequency response of the selected channel stored at the selected MCACC preset and its graph are displayed.

3 Press ← to highlight 'MCACC', then use ↑/↓ to select the MCACC preset you want to check.

Group Delay (SC-37 only)

Use this to display the calibrated speaker group delay results. See *Better sound using Phase Control and Full Band Phase Control (SC-37 only)* on page 63 for more on this.

1 Select 'Group Delay' from the MCACC Data Check menu.

2 When 'Channel' is highlighted, use ←/→ to select the channel you want to check.

The result of group delay calibration for the selected channel is displayed.

When measurements have been performed with **Full Auto MCACC** selected at **Advanced MCACC** or with **ALL** or **Full Band Phase Ctrl** selected when **Auto MCACC** is selected, the graph before group delay calibration is also displayed.

When **After** is selected at **Calibration**, the group delay after calibration is displayed. Compared to when **Before** is selected, with **After** there is less difference in the delay between frequency bands and the group delay between the different channels is uniform, allowing you to check the full band phase control effect.

No Data is displayed if the selected group delay has not been measured.

Output MCACC data

Before continuing, make sure you have completed step 2 in *Checking MCACC Data* on page 110. The data measured with the Advanced MCACC function is transmitted to the USB device.¹ The 3D graphs of the reverb characteristics and group delay characteristics² before and after calibration and the MCACC results (parameters) can be checked on your computer.

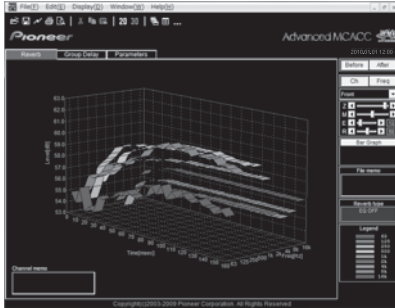

1 Select 'Output MCACC data' from the MCACC Data Check menu.

When the receiver is ready for transmission, **"Please connect your USB memory for the MCACC data, then press OK to output them."** shows on the GUI screen.

2 Connect your USB device to the USB terminal on the front panel, then select "OK".

"Please wait..." will be displayed on the screen and transmission of measurement data to the USB device will begin.

Transmission is complete when **"Complete"** is displayed.³

Data Management

This system allows you to store up to six MCACC presets, allowing you to calibrate your system for different listening positions (or frequency adjustments for the same listening position).⁴ This is useful for alternate settings to match the kind of source you're listening to and where you're sitting (for example, watching movies from a sofa, or playing a video game close to the TV).

From this menu you can copy from one preset to another, name presets for easier identification and clear any ones you don't need.

1 Set the remote control to the receiver operation mode, then press HOME MENU.

A Graphical User Interface (GUI) screen appears on your TV. Use **↑/↓/←/→** and **ENTER** to navigate through the screens and select menu items. Press **RETURN** to confirm and exit the current menu.

2 Select 'Data Management' from the Home Menu.

3 Select the setting you want to adjust.

- **Memory Rename** – Name your MCACC presets for easy identification (see *Renaming MCACC presets* below).
- **MCACC Memory Copy** – Copy settings from one MCACC preset to another (see *Copying MCACC preset data* on page 113).
- **MCACC Memory Clear** – Clear any MCACC presets that you don't want (see *Clearing MCACC presets* on page 113).

Renaming MCACC presets

If you have several different MCACC presets that you're using, you may want to rename them for easier identification.

1 Select 'Memory Rename' from the Data Management setup menu.

2 Select the MCACC preset you want to rename, then select an appropriate preset name.

Use **↑/↓** to select the preset, then **←/→** to select a preset name.

3 Repeat for as many MCACC presets as necessary, then press RETURN when you're finished.

You will return to the **Data Management** setup menu.

Note

¹ MCACC data and parameters are transferred from this receiver to a USB device and by connecting the USB device to a computer, the data is imported via the MCACC software in the computer. See *Connecting a USB device for Advanced MCACC output* on page 40 for more on this.

² Only for the SC-37, since this function is supported by the display of the group delay characteristics' 3D graphs.

³ Only one set of reverb characteristics is stored on the receiver. If you wish to compare several different measurement results, transmit the data to the USB memory each time reverb measurements are taken.

⁴ This can be done in *Automatically conducting optimum sound tuning (Full Auto MCACC)* on page 43 or *Automatic MCACC (Expert)* on page 104, either of which you should have already completed.

Copying MCACC preset data

If you want to manually adjust the Acoustic Calibration EQ (see *Manual MCACC setup* on page 106), we recommend copying your current settings¹ to an unused MCACC preset. Instead of just a flat EQ curve, this will give you a reference point from which to start.

1 Select 'MCACC Memory Copy' from the Data Management setup menu.

2 Select the setting you want to copy.

- **All Data** – Copies all the settings of the selected MCACC preset memory.
- **Level & Distance** – Copies only the channel level and speaker distance settings of the selected MCACC preset memory.

3 Select the MCACC preset you'll be copying the settings 'From', then specify where you want to copy them ('To').

Make sure you don't overwrite an MCACC preset you're currently using (this can't be undone).

4 Select 'OK' to confirm and copy the settings.

When **MCACC Memory Copy?** is displayed, select **YES**. If **NO** is selected, the memory is not copied.

Completed! shows in the GUI screen to confirm the MCACC preset has been copied, then you automatically return to the **Data Management** setup menu.

Clearing MCACC presets

If you are no longer using one of the MCACC presets stored in memory, you can choose to clear the calibration settings of that preset.

1 Select 'MCACC Memory Clear' from the Data Management setup menu.

2 Select the MCACC preset you want to clear.

Make sure you don't clear an MCACC preset you're currently using (this can't be undone).

3 Select 'OK' to confirm and clear the preset.

When **MCACC Memory Clear?** is displayed, select **YES**. If **NO** is selected, the memory is not cleared.

Completed! shows in the GUI screen to confirm the MCACC preset has been cleared, then you automatically return to the **Data Management** setup menu.

Note

¹ The settings made in *Automatically conducting optimum sound tuning (Full Auto MCACC)* on page 43 or *Automatic MCACC (Expert)* on page 104.

Chapter 12:

The System Setup and Other Setup menus



Important

- The procedure for setting the receiver operation mode differs for the remote controls included with the SC-37 and SC-35. For the SC-37's remote control, set the remote control operation selector switch to **RECEIVER**. For the SC-35's remote control, press the **RECEIVER** button. When "set the remote control to the receiver operation mode" is indicated in these instructions, use the respective procedure described above.

Making receiver settings from the System Setup menu

The following section describes how to change the speaker-related settings manually and make various other settings (input selection, OSD language selection, etc.).

1 Switch on the receiver and your TV.

Make sure that the TV's video input is set to this receiver.

2 Set the remote control to the receiver operation mode, then press HOME MENU.

A Graphical User Interface (GUI) screen appears on your TV. Use **↑/↓/←/→** and **ENTER** to navigate through the screens and select menu items. Press **RETURN** to confirm and exit the current menu.

- Press **HOME MENU** at any time to exit the **Home Menu**.

3 Select 'System Setup' from the Home Menu, then press ENTER.

4 Select the setting you want to adjust.

- Manual SP Setup** – Sets the type of connection used for surround back terminals and the size, number distance and overall balance of the connected speakers (see *Manual speaker setup* below).
- Input Setup** – Specifies what you've connected to the digital, HDMI and component video inputs (see *The Input Setup menu* on page 45).
- OSD Language** – The GUI screen's display language can be changed (see *Changing the OSD display language (OSD Language)* on page 43).
- Network Setup** – Conducts the setup necessary to connect this unit to the network (see *Network Setup menu* on page 117).

- Other Setup** – Makes customized settings to reflect how you are using the receiver (see *The Other Setup menu* on page 119).

Manual speaker setup

This receiver allows you to make detailed settings to optimize the surround sound performance. You only need to make these settings once (unless you change the placement of your current speaker system or add new speakers).

These settings are designed to customize your system, but if you're satisfied with the settings made in *Automatically conducting optimum sound tuning (Full Auto MCACC)* on page 43, it isn't necessary to make all of these settings.



CAUTION

- The test tones used in the **Manual SP Setup** are output at high volume.

1 Select 'Manual SP Setup', then press ENTER.

See *Making receiver settings from the System Setup menu* above if you're not already at this screen.

2 Select the setting you want to adjust.

If you are doing this for the first time, you may want to adjust these settings in order:

- Speaker System** – Specifies how you are using your surround back speakers (page 115).
- Speaker Setting** – Specifies the size and number of speakers you've connected (page 115).
- Channel Level** – Adjusts the overall balance of your speaker system (page 116).
- Speaker Distance** – Specifies the distance of your speakers from the listening position (page 116).
- X-Curve** – Adjusts the tonal balance of your speaker system for movie soundtracks (page 117).
- THX Audio Setting** – Specifies whether you are using a THX speaker setup (page 117).

3 Make the adjustments necessary for each setting, pressing RETURN to confirm after each screen.

Speaker system setting

- Default setting: **Normal(SB/FH)**

There are several ways you can use the speaker terminals with this receiver. In addition to a normal home theater setup where they are used for the front height speakers or front wide speakers, they can be used for bi-amping the front speakers or as an independent speaker system in another room.

1 Select 'Speaker System' from the Manual SP Setup menu.

See *Making receiver settings from the System Setup menu* on page 114 if you're not already at this screen.

2 Select the speaker system setting.

- **Normal(SB/FH)** – Select for normal home theater use with front height speakers in your main (speaker system A) setup.
- **Normal(SB/FW)** – Select for normal home theater use with front wide speakers in your main (speaker system A) setup.
- **Speaker B** – Select to use the B speaker terminals to listen to stereo playback in another room (see *Switching the speaker terminals* on page 79).
- **Front Bi-Amp** – Select this setting if you're bi-amping your front speakers (see *Bi-amping your speakers* on page 26).
- **ZONE 2** – Select to use the (surround back) B speaker terminals for an independent system in another zone (see *Using the MULTI-ZONE controls* on page 79).

3 If you selected Normal(SB/FH), Normal(SB/FW), or Speaker B in Step 2, select the placement of the surround speakers.

In a 7.1-channel surround system with surround speakers placed directly at the sides of the listening position, the surround sound of 5.1-channel sources is heard from the side. This function mixes the sound of the surround speakers with the surround back speakers so that the surround sound is heard from diagonally to the rear as it should be.¹

- **ON SIDE** – Select when the surround speakers is positioned right beside you.
- **IN REAR** – Select when the surround speaker is positioned obliquely behind you.

4 When 'Setting Change?' is displayed, select Yes.

If **No** is selected, the setting is not changed.

You will return to the **Manual SP Setup** menu.

Speaker Setting

Use this setting to specify your speaker configuration (size, number of speakers and crossover frequency)². It is a good idea to make sure that the settings made in *Automatically conducting optimum sound tuning (Full Auto MCACC)* on page 43 are correct. Note that this setting applies to all MCACC presets, and cannot be set independently.

1 Select 'Speaker Setting' from the Manual SP Setup menu.

2 Choose the set of speakers that you want to set, then select a speaker size.

Use **←/→** to select the size (and number) of each of the following speakers:³

- **Front** – Select **LARGE** if your front speakers reproduce bass frequencies effectively, or if you didn't connect a subwoofer. Select **SMALL** to send the bass frequencies to the subwoofer.
- **Center** – Select **LARGE** if your center speaker reproduces bass frequencies effectively, or select **SMALL** to send bass frequencies to the other speakers or subwoofer. If you didn't connect a center speaker, choose **NO** (the center channel is sent to the front speakers).
- **FH** – Select **LARGE** if your front height speakers reproduce bass frequencies effectively, or select **SMALL** to send bass frequencies to the other speakers or subwoofer. If you didn't connect front height speakers, choose **NO** (the front height channel is sent to the front speakers).⁴
- **FW** – Select **LARGE** if your front wide speakers reproduce bass frequencies effectively, or select **SMALL** to send bass frequencies to the other speakers or subwoofer. If you didn't connect front wide speakers, choose **NO** (the front wide channel is sent to the front speakers).⁵

Note

- 1 Depending on the positions of the speakers and the sound source, in some cases it may not be possible to achieve good results. In this case, set the setting to **ON SIDE** or **IN REAR**.
- 2 If you're using a THX speaker setup, set all speakers to **SMALL**.
- 3 If you select **SMALL** for the front speakers the subwoofer will automatically be fixed to **YES**. Also, the center, surround, surround back, front height and front wide speakers can't be set to **LARGE** if the front speakers are set to **SMALL**. In this case, all bass frequencies are sent to the subwoofer.
- 4 • You can adjust this setting only when **Speaker System** setting is **Normal(SB/FH)**.
• If the surround speakers are set to **NO**, this setting will automatically be set to **NO**.
- 5 • You can adjust this setting only when **Speaker System** setting is **Normal(SB/FW)**.
• If the surround speakers are set to **NO**, this setting will automatically be set to **NO**.

- **Surr** – Select **LARGE** if your surround speakers reproduce bass frequencies effectively. Select **SMALL** to send bass frequencies to the other speakers or subwoofer. If you didn't connect surround speakers choose **NO** (the sound of the surround channels is sent to the front speakers or a subwoofer).
 - **SB** – Select the number of surround back speakers you have (one, two or none).¹ Select **LARGE_{x2}** or **LARGE_{x1}** if your surround back speakers reproduce bass frequencies effectively. Select **SMALL_{x2}** or **SMALL_{x1}** to send bass frequencies to the other speakers or subwoofer. If you didn't connect surround back speakers choose **NO**.
 - **SW** – LFE signals and bass frequencies of channels set to **SMALL** are output from the subwoofer when **YES** is selected. Choose the **PLUS** setting if you want the subwoofer to output bass sound continuously or you want deeper bass (the bass frequencies that would normally come out the front and center speakers are also routed to the subwoofer).² If you did not connect a subwoofer choose **NO** (the bass frequencies are output from other speakers).
- 3 **Select 'X. OVER' and set the crossover frequency.**³ Frequencies below this point will be sent to the subwoofer (or **LARGE** speakers).
 - 4 **When you're finished, press RETURN.** You will return to the **Manual SP Setup** menu.

Channel Level

Using the channel level settings, you can adjust the overall balance of your speaker system, an important factor when setting up a home theater system.

- 1 **Select 'Channel Level' from the Manual SP Setup menu.**
- 2 **Select a setup option.**
 - **MANUAL** – Move the test tone manually from speaker to speaker and adjust individual channel levels.

- **AUTO** – Adjust channel levels as the test tone moves from speaker to speaker automatically.

3 Confirm your selected setup option.

The test tones will start after you press **ENTER**.

4 Adjust the level of each channel using ←/→.

If you selected **MANUAL**, use ↑/↓ to switch speakers. The **AUTO** setup will output test tones in the order shown on-screen:

Adjust the level of each speaker as the test tone is emitted.⁴

5 When you're finished, press RETURN.

You will return to the **Manual SP Setup** menu.



Tip

- You can change the channel levels by set the remote control to the receiver operation mode, then press **CH LEVEL**, and then using ←/→ on the remote control.

Speaker Distance

For good sound depth and separation from your system, you need to specify the distance of your speakers from the listening position. The receiver can then add the proper delay needed for effective surround sound.

1 Select 'Speaker Distance' from the Manual SP Setup menu.

2 Adjust the distance of each speaker using ←/→.

You can adjust the distance of each speaker in 1/2 inch Increments.

3 When you're finished, press RETURN.

You will return to the **Manual SP Setup** menu.



Tip

- For best surround sound, make sure the surround back speakers are the same distance from the listening position.

Note

- 1 • If you selected **ZONE 2** or **Front Bi-Amp** (in *Speaker system setting* on page 115) you can't adjust the surround back settings.
- If the surround speakers are set to **NO**, the surround back speakers will automatically be set to **NO**.
- 2 If you have a subwoofer and like lots of bass, it may seem logical to select **LARGE** for your front speakers and **PLUS** for the subwoofer. This may not, however, yield the best bass results. Depending on the speaker placement of your room you may actually experience a decrease in the amount of bass due low frequency cancellations. In this case, try changing the position or direction of speakers. If you can't get good results, listen to the bass response with it set to **PLUS** and **YES** or the front speakers set to **LARGE** and **SMALL** alternatively and let your ears judge which sounds best. If you're having problems, the easiest option is to route all the bass sounds to the subwoofer by selecting **SMALL** for the front speakers.
- 3 • This setting decides the cutoff between bass sounds playing back from the speakers selected as **LARGE**, or the subwoofer, and bass sounds playing back from those selected as **SMALL**. It also decides where the cutoff will be for bass sounds in the LFE channel.
 - With Full Auto MCACC Setup or Auto MCACC Setup (**ALL** or **Speaker Setting**), the setting here will not apply and the crossover frequency will be automatically set. Crossover frequency is a frequency aimed at achieving the optimal sound field taking into account the bass capacity of all connected speakers and human aural characteristics.
 - If you're using THX speakers, confirm that the crossover frequency is set to **80Hz**.
- 4 If you are using a Sound Pressure Level (SPL) meter, take the readings from your main listening position and adjust the level of each speaker to 75 dB SPL (C-weighting/slow reading).

X-Curve

Most soundtracks mixed for cinema sound too bright when played back in large rooms. The X-Curve setting acts as a kind of re-equalization for home theater listening, and restores proper tonal balance of movie soundtracks.¹

1 Select 'X-Curve' from the Manual SP Setup menu.

2 Choose the X-Curve setting you want.

Use **←/→** to adjust the setting. The X-Curve is expressed as a downwards slope in decibels per octave, starting at 2 kHz. The sound becomes less bright as the slope increases (to a maximum of **-3.0dB/oct**). Use the following guidelines to set the X-Curve according to your room size:

Room size (ft ²)	≤400	≤550	≤650	≤800	≤2200	≤12000
X-Curve (dB/oct)	-0.5	-1.0	-1.5	-2.0	-2.5	-3.0

- If you select **OFF**, the frequency curve will be flat and the X-Curve has no effect.

3 When you're finished, press RETURN.

THX Audio Setting

This menu allows the user to adjust various THX features including Loudness Plus, SBch processing, SB Speaker Position, THX Ultra2/Select2² Subwoofer (on/off), and Boundary Gain Control. Please see page 135 for details regarding these THX features.

1 Select 'THX Audio Setting' from the Manual SP setup menu.

2 Select either ON or OFF for the THX Loudness Plus setting.

3 Specify whether the SBch processing is AUTO or MANUAL.

- **AUTO** – When surround back speakers are connected, whether or not surround back channel signals are present in the audio signals being input is detected and the appropriate THX surround mode is set.
- **MANUAL** – The desired THX surround mode can be selected regardless of whether or not surround back channel signals are present in the audio signals being input.

4 Specify the distance of your surround back speakers from each other.

- **0-1 ft** – Surround back speakers within 1 foot apart.
- **>1-4 ft** – Surround back speakers between 1 and 4 feet apart.
- **4 ft<** – Surround back speakers more than 4 feet apart (default).

5 Specify whether your subwoofer is Ultra2/Select2² certified or not.

If your subwoofer isn't THX Ultra2/Select2² certified, but you still want to switch boundary gain compensation on, select **YES** here, but the effect might not work properly.

6 Select either ON or OFF for Boundary Gain Compensation setting.

7 When you're finished, press RETURN.

You will return to the **Manual SP Setup** menu.

Network Setup menu

Setting up the network to listen to Internet radio on this receiver.

1 Set the remote control to the receiver operation mode, then press HOME MENU.

A Graphical User Interface (GUI) screen appears on your TV. Use **↑/↓/←/→** and **ENTER** to navigate through the screens and select menu items. Press **RETURN** to confirm and exit the current menu.

2 Select 'System Setup' from the Home Menu.

3 Select 'Network Setup' from the System Setup menu.

4 Select the setting you want to adjust.

If you are doing this for the first time, you may want to adjust these settings in order:

- **IP Address, Proxy** – Sets up the IP address/Proxy of this receiver (page 118).
- **Information** – Checks the MAC address and the firmware version of the Network section of this receiver (page 118).
- **Network Standby** – Allows the Web Control function to be used even when the receiver is in the standby mode (page 118).

Note

¹ Since the principal is the same, X-Curve isn't applied when you're using any of the Home THX, Pure direct or Optimum surround modes.
² Ultra2 for the SC-37, Select2 for the SC-35.

IP address/Proxy setting

In case the router connected to the LAN terminal on this receiver is a broadband router (with a built-in DHCP server function), simply turn on the DHCP server function, and you will not need to set up the network manually. You must set up the network as described below only when you have connected this receiver to a broadband router without a DHCP server function. Before you set up the network, consult with your ISP or the network manager for the required settings. It is advised that you also refer to the operation manual supplied with your network component.¹

IP Address

The IP address to be entered must be defined within the following ranges. If the IP address defined is beyond the following ranges, you cannot play back audio files stored on components on the network or listen to Internet radio stations.

Class A: 10.0.0.1 to 10.255.255.254

Class B: 172.16.0.1 to 172.31.255.254

Class C: 192.168.0.1 to 192.168.255.254

Subnet Mask

In case an xDSL modem or a terminal adapter is directly connected to this receiver, enter the subnet mask provided by your ISP on paper. In most cases, enter 255.255.255.0.

Default Gateway

In case a gateway (router) is connected to this receiver, enter the corresponding IP address.

Primary DNS Server/Secondary DNS Server

In case there is only one DNS server address provided by your ISP on paper, enter it in the 'Primary DNS Server' field. In case there are more than two DNS server addresses, enter 'Secondary DNS Server' in the other DNS server address field.

Proxy Hostname/Proxy Port

This setting is required when you connect this receiver to the Internet via a proxy server. Enter the IP address of your proxy server in the 'Proxy Hostname' field. Also, enter the port number of your proxy server in the 'Proxy Port' field.



Tip

- Press **↑/↓** or the numeric buttons to enter alphanumeric characters. To delete alphanumeric characters entered one at a time, press **CLEAR**.

1 Select 'IP Address, Proxy' from the Network Setup menu.

2 Select the DHCP setting you want.

When you select **ON**, the network is automatically set up, and you do not need to follow Steps 3. Proceed with Step 4.

If there is no DHCP server on the network and you select **ON**, this receiver will use its own Auto IP function to determine the IP address.²

3 Enter the IP Address, Subnet Mask, Default Gateway, Primary DNS Server and Secondary DNS Server.

Press **↑/↓** to select a number and **←/→** to move the cursor.

4 Select 'OFF' or 'ON' for the Enable Proxy Server setting to deactivate or activate the proxy server.

In case you select **'OFF'**, proceed with Step 7. In case you select **'ON'**, on the other hand, proceed with Step 5.

5 Enter the address of your proxy server or the domain name.

6 Enter the port number of your proxy server.

Use the numeric buttons to enter the port number.

7 Select 'OK' to confirm the IP Address/Proxy setup.

Checking the MAC address

You can check the MAC address.

1 Select 'Information' from the Network Setup menu.

Network Standby

This setting allows the **Web Control** function (page 81) for operating the receiver from a computer connected on the same LAN as the receiver to be used even when the receiver is in the standby mode.

1 Select 'Network Standby' from the Network Setup menu.

2 Specify whether the Network Standby is ON or OFF.

- **ON** – The Web Control function can be used even when the receiver is in the standby mode.
- **OFF** – The Web Control function cannot be used when the receiver is in the standby mode (This lets you reduce power consumption in the standby mode).

Note

¹ In case you make changes to the network configuration without the DHCP server function, make the corresponding changes to the network settings of this receiver.

² The IP address determined by the Auto IP function is 169.254.X.X. You cannot listen to an Internet radio station if the IP address is set for the Auto IP function.

The Other Setup menu

The **Other Setup** menu is where you can make customized settings to reflect how you are using the receiver.

1 Set the remote control to the receiver operation mode, then press HOME MENU.

A Graphical User Interface (GUI) screen appears on your TV. Use **↑/↓/←/→** and **ENTER** to navigate through the screens and select menu items. Press **RETURN** to confirm and exit the current menu.

2 Select 'System Setup' from the Home Menu.

3 Select 'Other Setup', then press ENTER.

4 Select the setting you want to adjust.

If you are doing this for the first time, you may want to adjust these settings in order:

- **HDMI Setup** – Synchronizes this receiver with your Pioneer component supporting **Control** with HDMI (page 73).
- **Volume Setup** – Sets up the volume-related operations of this receiver (see below).
- **Remote Control Mode Setup** – Sets this receiver's remote control mode (see below).
- **Flicker Reduction** – Adjusts the way the GUI screen looks (page 120).
- **RF Remote Setup** (*SC-37 only*) – Allows the CU-RF100 to be used even when the receiver is in the standby mode (page 120).
- **EXTENSION Setup** (*SC-35 only*) – Allows the CU-RF100 to be used even when the receiver is in the standby mode (page 120).
- **Multi Ch In Setup** – Specifies the optional settings for a multi-channel input (page 120).
- **Pairing Bluetooth Setup** – Use to pair a *Bluetooth ADAPTER* and *Bluetooth* wireless technology device (page 58).

5 Make the adjustments necessary for each setting, pressing RETURN to confirm after each screen.

Volume Setup

You can set the maximum volume of this receiver or specify what the volume level will be when the power is turned on.

1 Select 'Volume Setup' from the Other Setup menu.

2 Select the Power ON Level setting you want.

The volume can be set so that it is always set to the same level when the receiver's power is turned on.

- **LAST** (default) – When the power is turned on, the volume is set to the same level as when the power was last turned off.
- **"---** – When the power is turned on, the volume is set to minimum level.
- **-80.0dB to +12.0dB** – Specify the volume to be set when the power is turned on, in steps of 0.5 dB.

It is not possible to set a volume level greater than the value specified at Volume Limit setup (see below).

3 Select the Volume Limit setting you want.

Use this function to limit the maximum volume. The volume cannot be increased above the level set here, even by operating **MASTER VOLUME** button (or the dial on the front panel).

- **OFF** (default) – The maximum volume is not limited.
- **-20.0dB/-10.0dB/0.0dB** – The maximum volume is limited to the value set here.

4 Select the Mute Level setting you want.

This sets how much the volume is to be turned down when **MUTE** is pressed.

- **FULL** (default) – No sound.
- **-40.0dB/-20.0dB** – The volume will be turned down to the level specified here.

5 When you're finished, press RETURN.

You will return to the **Other Setup** menu.

Remote Control Mode Setup

- Default setting: **1**

This sets this receiver's remote control mode to prevent erroneous operation when multiple units of the receiver are being used.

1 Select 'Remote Control Mode Setup' from the Other Setup menu.

2 Select the Remote Control Mode setting you want.

3 Select "OK" to change the remote control mode.

4 Follow the instructions on the screen to change the remote control's setting.

See *Operating multiple receivers* on page 84 (SC-37)/page 96 (SC-35).

5 When you're finished, press RETURN.

You will return to the **Other Setup** menu.

Flicker Reduction Setup

- Default setting: **OFF**

The GUI screen's resolution can be increased. If you feel the GUI screen is hard to see, try changing this setting. Note that the resolution in this setting only affects the GUI screen; it has no influence on the video output.

- 1 **Select 'Flicker Reduction Setup' from the Other Setup menu.**
- 2 **Select the Flicker Reduction setting you want.**
- 3 **When you're finished, press RETURN.**
You will return to the **Other Setup** menu.

RF Remote Setup *(SC-37 only)*

- Default setting: **OFF**

The CU-RF100 can be used to operate the receiver by RF communications. To do so, set the **RF Remote** setting to **ON**. When **ON** is set here, the receiver can be operated even when the receiver is in the standby mode.

- 1 **Select 'RF Remote Setup' from the Other Setup menu.**
- 2 **Select the RF Remote setting you want.**
- 3 **When you're finished, press RETURN.**
You will return to the **Other Setup** menu.

EXTENSION Setup *(SC-35 only)*

- Default setting: **OFF**

The CU-RF100 can be used to operate the receiver by RF communications. To do so, set the **EXTENSION** setting to **ON**. When **ON** is set here, the receiver can be operated even when the receiver is in the standby mode.

- 1 **Select 'EXTENSION Setup' from the Other Setup menu.**
- 2 **Select the EXTENSION setting you want.**
- 3 **When you're finished, press RETURN.**
You will return to the **Other Setup** menu.

Multi Channel Input Setup

You can adjust the level of the subwoofer for a multi-channel input. Also, when the multi-channel input is selected as an input function, you can display the video images of other input functions. In the Multi Channel Input Setup, you can assign a video input to the multi-channel input.

- 1 **Select 'Multi Ch In Setup' from the Other Setup menu.**
- 2 **Select the 'SW Input Gain' setting you want.**
 - **0dB** – Outputs sound of the subwoofer at the level originally recorded on the source.
 - **+10dB** – Outputs sound of the subwoofer at the level increased by 10 dB.
- 3 **Select the 'Video Input' setting you want.**
When the multi-channel input is selected as an input function, you can display the video images of other input functions. The video input can be selected from the following: **DVD**, **TV/SAT**, **DVR/BDR**, **VIDEO**, **OFF**.
- 4 **When you're finished, press RETURN.**
You will return to the **Other Setup** menu.

Chapter 13: Additional information

Speaker Setting Guide

In order to achieve an even better surround effect, it is important to accurately position the speakers and make their volume and tone characteristics uniform so as to finely focus the multi-channel sound.

The three major elements in positioning the speakers are **distance**, **angle** and **orientation** (the direction in which the speakers are pointing).

Distance: The distance of all the speakers should be equal.

Angle: The speakers should be horizontally symmetrical.

Orientation: The orientation should be horizontally symmetrical.

In most homes, however, it is not possible to achieve this environment. For the distance, on this receiver it is possible to automatically correct the speaker distance electrically to a precision of $\frac{1}{2}$ inch using the Full Auto MCACC Setup function (page 43).

SC-37 only: For the volume and sound quality as well, accurate sound field correction using the equalizer and speaker phase characteristic correction using the Full Band Phase Control function (page 63) together make it possible to achieve the ideal listening environment.

Step 1: Speaker layout and distance adjustment

Use speaker stands or the like to make sure the speakers are steady, and leave at least 10 cm (4 inches) from the surrounding walls. Position the speakers attentively so that the speakers on the left and right are at equal angles from the listening position (center of the adjustments). (We recommend using cords, etc., when adjusting the layout.) Ideally all the speakers should be equidistant from the listening position.



Tip

- If the speakers cannot be set at equal distances (on a circle), use the Auto MCACC Setup speaker distance correction and Fine Speaker Distance (or Precision Distance – *SC-37 only*) functions to make them equalize the distance artificially.

Step 2: Adjusting the speaker height

Adjust the heights (angles) of the different speakers.

Adjust so that the front speaker units reproducing mid- and high frequencies is roughly at the height of the ears.

If the center speaker cannot be set at the same height as the front speakers, adjust its angle of elevation to point it to the listening position.

Set surround speaker 1 so that it is not under the height of the ears.

Step 3: Adjusting the speaker orientation

If the left and right speakers are not pointing in the same direction, the tone will not be the same on the right and left, and as a result the sound field will not be reproduced properly. However, if all the speakers are pointed towards the listening position, the sound field will seem cramped. Testing by the Pioneer Multi-channel Research Group has shown that a good sense of sound positioning can be achieved by pointing all the speakers towards an area 30 cm to 80 cm (12 inches to 31 inches) behind the listening position (between the surround speakers and the listening position).

However, the sense of sound positioning can differ according to the conditions in the room and the speakers being used. In smaller environments in particular (when the front speakers are close to the listening position), with this method the speakers will be pointed too inward. We suggest you use this example of installation as reference when trying out different installation methods.

Step 4: Positioning and adjusting the subwoofer

Placing the subwoofer between the center and front speakers makes even music sources sound more natural (if there is only one subwoofer, it doesn't matter if it is placed on the left or right side). The low bass sound output from the subwoofer is not directional and there is no need to adjust the height. Normally the subwoofer is placed on the floor. Put it in a position at which it will not cancel out the bass sound output from the other speakers. Also note that placing it near a wall may result in sympathetic vibrations with the building that could excessively amplify the bass sound.

If the subwoofer must be installed near a wall, place it at an angle so that it is not parallel to the wall surface. This can help reduce any sympathetic vibrations, but depending on the shape of the room this could result in standing waves. However, even if standing waves are generated, their influence on the sound quality can be prevented using the Auto MCACC's standing wave control function (page 111).

Step 5: Default settings with the Auto MCACC Setup (auto sound field correction) function

It is more effective to perform the Full Auto MCACC Setup (page 43) and Precision Distance (*SC-37 only*) (page 110) procedure once the adjustments described above have been completed.

Tip

- The distance to the subwoofer may be slightly larger than the distance actually measured with a tape measure, etc. This is because this distance is corrected for electric delay, and is not a problem.

Positional relationship between speakers and monitor

Position of front speakers and monitor

The front speakers should be as equidistant as possible to the monitor.

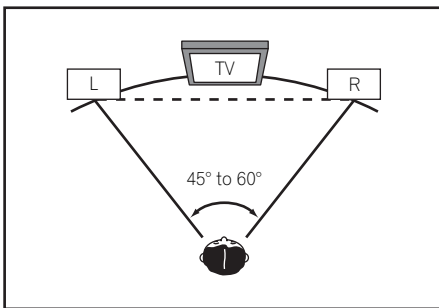

Position of center speaker and monitor

Since mostly dialogs are output from the center speaker, keeping the center speaker as close as possible to the screen makes the overall sound more natural. For TVs using Braun tubes, however, when installing the center speaker on the floor, adjust its angle of elevation to point it towards the listening position.

Installation on floor

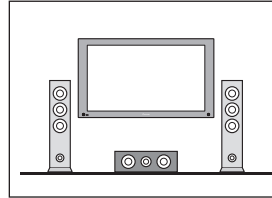

(Diagram as seen from the side)

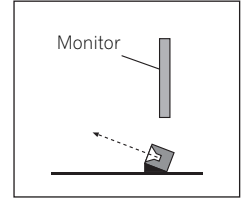

- If the center speaker is not of the shielded type, install it away from the TV.
- When installing the center speaker on top of the monitor, place it facing slightly downwards towards the listening position.

Troubleshooting

Incorrect operations are often mistaken for trouble and malfunctions. If you think that there is something wrong with this component, check the points below. Sometimes the trouble may lie in another component. Investigate the other components and electrical appliances being used. If the trouble cannot be rectified even after exercising the checks listed below, ask your nearest Pioneer authorized independent service company to carry out repair work.

Note

- If the unit does not operate normally due to external effects such as static electricity disconnect the power plug from the outlet and insert again to return to normal operating conditions.

Power

Symptom	Remedy
The power does not turn on.	<ul style="list-style-type: none"> • Make sure that the power cord is plugged in to an active power outlet. • Try disconnecting from the power outlet, then plugging back in. <p><i>SC-37 only:</i></p> <ul style="list-style-type: none"> • When remote control operation is set to RF two-way communications, the receiver's power cannot be turned on unless RF Remote Setup is set to ON (see <i>RF Remote Setup (SC-37 only)</i> on page 120). • When remote control operation is set to RF two-way communications, check whether the RF adapter is properly connected to the receiver.
Power cannot be turned off. (ZONE 2 ON or ZONE 3 ON is displayed.)	<ul style="list-style-type: none"> • Set the remote control's MULTI-ZONE operation selector switch to ZONE 2 or ZONE 3, then press RECEIVER to switch the sub zone off.
The receiver suddenly switches off or the iPod iPhone indicator blinks.	<ul style="list-style-type: none"> • Check that there are no loose strands of speaker wire touching the rear panel or another set of wires. If so, re-attach the speaker wires, making sure there are no stray strands. • The receiver may have a serious problem. Disconnect from the power and call a Pioneer authorized independent service company.

Symptom	Remedy
During loud playback the power suddenly switches off.	<ul style="list-style-type: none"> • Turn down the volume. • Lower the 63 Hz and 125 Hz equalizer levels in the <i>Manual MCACC setup</i> on page 106. • Switch on the digital safety feature. While holding down ENTER on the front panel, press STANDBY/ON to set this receiver to the standby mode. Use TUNE ↑/↓ to select D.SAFETY <OFF>, and then use PRESET ←/→ to select 1 or 2 (select D.SAFETY <OFF> to deactivate this feature). If the power switches off even with 2 switched on, turn down the volume. With 1 or 2 on, some features may be unavailable.
The unit does not respond when the buttons are pressed.	<ul style="list-style-type: none"> • Try switching the receiver off, then back on again. • Try disconnecting the power cord, then connect again.
AMP ERR blinks in the display, then the power automatically switches off. The ADVANCED MCACC blinks and the power does not turn on.	<ul style="list-style-type: none"> • The receiver may have a serious problem. Do not try switching the receiver on. Unplug the receiver from the wall and call a Pioneer authorized independent service company.
The PQLS flashes and power turns off.	<ul style="list-style-type: none"> • There is a problem with the receiver's power unit or fan. Try turning on the power after 1 minute. If the same thing happens, the receiver is damaged. Unplug the receiver from the wall and call a Pioneer authorized independent service company. (Other symptoms may appear when the power is turned on.)
OVERHEAT blinks in the display or AMP OVERHEAT and the power indicator flash and the power turns off.	<ul style="list-style-type: none"> • Allow the unit to cool down in a well-ventilated place before switching back on. • Wait at least 1 minute, then try turning the power on again.
The receiver suddenly power off or ADVANCED MCACC flashes.	<ul style="list-style-type: none"> • The power unit is damaged. Unplug the receiver from the wall and call a Pioneer authorized independent service company.
Display blinks 12V TRG ERR .	<ul style="list-style-type: none"> • An error has arisen in the 12 V trigger jacks. Reconnect accurately then turn the power back on.

No sound

Symptom	Remedy
No sound is output when an input function is selected. No sound is output from the front speakers.	<ul style="list-style-type: none"> • Check the volume, mute setting (press MUTE) and speaker setting (press SPEAKERS). • Make sure the correct input function is selected. • Check that the MCACC setup microphone is disconnected. • Make sure the correct input signal is selected (press SIGNAL SEL). Note that when PCM is selected, you won't be able to hear any other signal format. • Check that the source component is connected properly (see <i>Connecting your equipment</i> on page 20). • Check that the speakers are connected properly (see <i>Connecting the speakers</i> on page 24).
No sound from the surround or center speakers.	<ul style="list-style-type: none"> • Check that the Stereo listening mode or the Front Stage Surround Advance mode isn't selected; select one of the surround listening modes (see <i>Listening in surround sound</i> on page 59). • Check that the surround/center speakers are not set to NO (see <i>Speaker Setting</i> on page 115). • Check the channel level settings (see <i>Channel Level</i> on page 116). • Check the speaker connections (see <i>Connecting the speakers</i> on page 24).
No sound from surround back speakers.	<ul style="list-style-type: none"> • Check that the surround back speakers are set to LARGE or SMALL, and the surround speakers are not set to NO (see <i>Speaker Setting</i> on page 115). • Check the speaker connections (see <i>Connecting the speakers</i> on page 24). If only one surround back speaker is connected, make sure it's connected to the left channel speaker terminal. • Surround back speakers will not play while the Speaker System is set to Speaker B and audio is being played through speaker B.
No sound from front height or front wide speakers.	<ul style="list-style-type: none"> • Check that the front height or front wide speakers are set to LARGE or SMALL, and the surround speakers are not set to NO (see <i>Speaker Setting</i> on page 115). • Check the speaker connections (see <i>Connecting the speakers</i> on page 24).

Symptom	Remedy
No sound from subwoofer.	<ul style="list-style-type: none"> • Check that the subwoofer is connected properly, switched on and the volume turned up. • If your subwoofer has a sleep function, make sure it is switched off. • Make sure that the Subwoofer setting is YES or PLUS (see <i>Speaker Setting</i> on page 115). • The crossover frequency may be set too low; try setting it higher to match the characteristics of your other speakers (see <i>Speaker Setting</i> on page 115). • If there is very little low frequency information in the source material, change your speaker settings to Front: SMALL / Subwoofer: YES, or Front: LARGE / Subwoofer: PLUS (see <i>Speaker Setting</i> on page 115). • Check that the LFE channel is not set to OFF, or to a very quiet setting (see <i>Setting the Audio options</i> on page 76). • Check the speaker level settings (see <i>Channel Level</i> on page 116).
No sound from one speaker.	<ul style="list-style-type: none"> • Check the speaker connection (see <i>Connecting the speakers</i> on page 24). • Check the speaker level settings (see <i>Channel Level</i> on page 116). • Check that the speaker hasn't been set to NO (see <i>Speaker Setting</i> on page 115). • The channel may not be recorded in the source. By using one of the advanced effect listening modes, you may be able to create the missing channel (see <i>Listening in surround sound</i> on page 59).
Sound is produced from analog components, but not from digital ones (DVD, LD, CD-ROM, etc.).	<ul style="list-style-type: none"> • Check that the input signal type is set to DIGITAL (see <i>Choosing the input signal</i> on page 62). • Make sure that the digital input is assigned correctly for the input jack the component is connected to (see <i>The Input Setup menu</i> on page 45). • Check the digital output settings on the source component. • If the source component has a digital volume control, make sure this is not turned down. • Make sure that the multichannel analog inputs are not selected. Select any other input function.
No sound is output or a noise is output when Dolby Digital/DTS software is played back.	<ul style="list-style-type: none"> • Check that your DVD player is compatible with Dolby Digital/DTS discs. • Check the digital output settings of your DVD player. Make sure that the DTS signal output is set to On. • If the source component has a digital volume control, make sure this is not turned down.
No sound when using the Home Menu .	<ul style="list-style-type: none"> • If the HDMI input function is selected, sound is muted until exiting the Home Menu.

Other audio problems

Symptom	Remedy
Broadcast stations cannot be selected automatically, or there is considerable noise in radio broadcasts.	<p><i>For FM broadcasts</i></p> <ul style="list-style-type: none"> • Fully extend the FM wire antenna, adjust the position for best reception and secure to a wall, etc. • Use an outdoor antenna for better reception (see page 37). <p><i>For AM broadcasts</i></p> <ul style="list-style-type: none"> • Adjust the position and direction of the AM antenna. • Use an outdoor antenna for better reception (see page 37). • Noise may be caused by interference from other equipment, such as a fluorescent light, motor, etc. Switch off or move the other equipment, or move the AM antenna.
Noise is output when scanning a DTS CD.	<ul style="list-style-type: none"> • This is not a malfunction of the receiver. The scan function of your player alters the digital information, making it unreadable, resulting in noise being output. Lower the volume when scanning.
When playing a DTS format LD there is audible noise on the soundtrack.	<ul style="list-style-type: none"> • Make sure that the input signal type is set to DIGITAL (see <i>Choosing the input signal</i> on page 62).
Can't record audio.	<ul style="list-style-type: none"> • You can only make a digital recording from a digital source, and an analog recording from an analog source. • For digital sources, make sure that what you're recording isn't copy protected. • Check that the OUT jacks are properly connected to the recorders input jacks (see <i>Connecting the multichannel analog inputs</i> on page 34).
Subwoofer output is very low.	<ul style="list-style-type: none"> • To route more signal to the subwoofer, set it to PLUS or set the front speakers to SMALL (see <i>Speaker Setting</i> on page 115).
Everything seems to be set up correctly, but the playback sound is odd.	<ul style="list-style-type: none"> • The speakers may be out of phase. Check that the positive/negative speaker terminals on the receiver are matched with the corresponding terminals on the speakers (see <i>Connecting the speakers</i> on page 24).

Symptom	Remedy
The PHASE CONTROL feature doesn't seem to have an audible effect.	<ul style="list-style-type: none"> • If applicable, check that the lowpass filter switch on your subwoofer is off, or the lowpass cutoff is set to the highest frequency setting. If there is a PHASE setting on your subwoofer, set it to 0° (or depending on the subwoofer, the setting where you think it has the best overall effect on the sound). • Make sure the speaker distance setting is correct for all speakers (see <i>Speaker Distance</i> on page 116).
<i>SC-37 only</i> : Full Band Phase Control cannot be selected.	<ul style="list-style-type: none"> • Perform Full Auto MCACC measurements (see <i>Automatically conducting optimum sound tuning (Full Auto MCACC)</i> on page 43). Full Band Phase Control automatically turns on once measurements are completed.
Noise or hum can be heard even when there is no sound being input.	<ul style="list-style-type: none"> • Check that personal computers or other digital components connected to the same power source are not causing interference.
Can't select some Input functions by the INPUT SELECTOR on the front panel or the INPUT SELECT button on the remote control.	<ul style="list-style-type: none"> • Check the Input Skip settings in the Input Setup menu. • Check the HDMI Input assignment in the Input Setup menu then try OFF.
There seems to be a time lag between the speakers and the output of the subwoofer.	<ul style="list-style-type: none"> • See <i>Automatically conducting optimum sound tuning (Full Auto MCACC)</i> on page 43 to set up your system again using MCACC (this will automatically compensate for a delay in the subwoofer output).
The maximum volume available (shown in the front panel display) is lower than the +12dB maximum.	<ul style="list-style-type: none"> • Check that the Volume Limit is set to OFF (see <i>Volume Setup</i> on page 119). • The channel level setting may be over 0dB.

ADAPTER PORT

Symptom	Remedy
The <i>Bluetooth</i> wireless technology device cannot be connected or operated. Sound from the <i>Bluetooth</i> wireless technology device is not emitted or the sound is interrupted.	<ul style="list-style-type: none"> • Check that no object that emits electromagnetic waves in the 2.4 GHz band (microwave oven, wireless LAN device or <i>Bluetooth</i> wireless technology apparatus) is near the unit. If such an object is near the unit, set the unit far from it. Or, stop using the object emitting the electromagnetic waves. • Check that the <i>Bluetooth</i> wireless technology device is not too far from the unit and that obstructions are not set between the <i>Bluetooth</i> wireless technology device and the unit. Set the <i>Bluetooth</i> wireless technology device and the unit so that the distance between them is less than about 10 m and no obstructions exist between them. • Check that the <i>Bluetooth</i> ADAPTER and the ADAPTER PORT of the unit are correctly connected. • The <i>Bluetooth</i> wireless technology device may not be set to the communication mode supporting the <i>Bluetooth</i> wireless technology. Check the setting of the <i>Bluetooth</i> wireless technology device. • Check that pairing is correct. The pairing setting was deleted from this unit or the <i>Bluetooth</i> wireless technology device. Reset the pairing. • Check that the profile is correct. Use a <i>Bluetooth</i> wireless technology device that supports A2DP profile and AVRCP profile.

Video

Symptom	Remedy
No image is output when an input is selected.	<ul style="list-style-type: none"> • Check the video connections of the source component (see page 32). • For HDMI, or when digital video conversion is set to OFF and a TV and another component are connected with different cords (in <i>Setting the Video options</i> on page 78), you must connect your TV to this receiver using the same type of video cable as you used to connect your video component. • Make sure the input assignment is correct for components connected using component video or HDMI cables (see <i>The Input Setup menu</i> on page 45). • Check the video output settings of the source component. • Check that the video input you selected on your TV is correct. • Some components (such as video game units) have resolutions that may not be converted. If adjusting this receiver's Resolution setting (in <i>Setting the Video options</i> on page 78) and/or the resolution settings on your component or display doesn't work, try switching Digital Video Conversion (in <i>Setting the Video options</i> on page 78) to OFF.

Symptom	Remedy
Can't record video.	<ul style="list-style-type: none"> • Check that the source is not copy-protected. • The video converter is not available when making recordings. Check that the same type of video cable is used for connecting both the recorder and the video source (the one you want to record) to this receiver.
Noisy, intermittent, or distorted picture.	<ul style="list-style-type: none"> • Sometimes a video deck may output a noisy video signal (during scanning, for example), or the video quality may just be poor (with some video game units, for example). The picture quality may also depend on the settings, etc. of your display device. Switch off the video converter and reconnect the source and display device using the same type of connection (component or composite), then start playback again.
Video signals are not output from the component terminal.	<ul style="list-style-type: none"> • When a monitor only compatible with resolutions of 480i is connected to the component terminal and another monitor is connected to the HDMI terminal, the video signals may not be output to the monitor connected to the component terminal. If this happens, do the following: <ul style="list-style-type: none"> – Turn off the power of the monitor connected to the HDMI terminal. – Change the VIDEO PARAMETER menu RES setting. – Video signals from the HDMI terminal cannot be output to the component terminals. Input the video signals from the player or other source to the composite or component terminals. When using the component terminal, assign it at Input Setup.

Settings

Symptom	Remedy
The Auto MCACC Setup continually shows an error.	<ul style="list-style-type: none"> • The ambient noise level may be too high. Keep the noise level in the room as low as possible (see also <i>Problems when using the Auto MCACC Setup</i> on page 45). If the noise level cannot be kept low enough, you will have to set up the surround sound manually (page 114). • When using only one surround back speaker, connect it to the SURROUND BACK L (Single) terminals. • To use a 5.1-channel speaker set, use the surround speakers for the surround channel, not the surround back channel. • Make sure there are no obstacles between the speakers and the microphone. • If Reverse Phase is displayed, try the following: <ul style="list-style-type: none"> – The speaker's wiring (+ and –) may be inverted. Check the speaker connections. – Depending on the type of speakers and their installation conditions, Reverse Phase may be displayed even if the speakers are properly connected. If this happens, select GO NEXT and continue. – If the speaker is not pointed to the microphone (listening position) or when using speakers that affect the phase (dipole speakers, reflective speakers, etc.), it may not be possible to properly identify the polarity.
After using the Auto MCACC Setup, the speaker size setting is incorrect.	<ul style="list-style-type: none"> • There may have been some low frequency noise in the room from an air-conditioner, motor, etc. Switch off all other appliances in the room and use Auto MCACC Setup again. • Depending on a number of factors (bass reproduction capabilities of the speakers, room size, speaker placement, etc.) this may occur in some cases. Change the speaker setting manually in <i>Speaker Setting</i> on page 115, and use the ALL (Keep SP System) option for the Auto MCACC menu in <i>Automatic MCACC (Expert)</i> on page 104 if this is a recurring problem.
Can't adjust the Fine Speaker Distance setting (page 107) properly.	<ul style="list-style-type: none"> • Check that the speakers are all in phase (make sure the positive (+) and negative (–) terminals are matched up properly).
SC-37 only: Gauge (value) does not increase with the Precision Distance adjustment.	<ul style="list-style-type: none"> • Check that the speakers are all in phase (make sure the positive (+) and negative (–) terminals are matched up properly). • Perform the Full Auto MCACC procedure before the Precision Distance adjustment (see <i>Automatically conducting optimum sound tuning (Full Auto MCACC)</i> on page 43). • Place the microphone accurately in the same position as when the Full Auto MCACC procedure was performed. • Do not move the speaker used as the reference point. Also, adjust in order, starting from the front right speaker. • When adjusting the speaker positions, do not move the speakers much; only move them about 1 inch towards or away from the microphone. • If you forget exactly where the microphone should be positioned or if there are problems after the procedure has been performed repeatedly, re-calibrate the distance using the Full Auto MCACC procedure, then without moving the microphone redo the Precision Distance adjustment.

Symptom	Remedy
The display shows KEY LOCK ON when you try to make settings.	<ul style="list-style-type: none"> With the receiver in standby, press ⏻ STANDBY/ON for about 10 seconds while holding down SPEAKERS to disable the key lock.
Most recent settings have been erased.	<ul style="list-style-type: none"> The power cord was disconnected from the wall while adjusting this setting. Settings are only stored if all the zones are turned off. Turn off all the zones before unplugging the power cord.
The various system settings are not stored.	<ul style="list-style-type: none"> Make sure the blue ⏻ STANDBY/ON light has gone out before unplugging.

Professional Calibration EQ graphical output

Symptom	Remedy
The EQ response displayed in the graphical output following calibration does not appear entirely flat.	<ul style="list-style-type: none"> There are cases where the graph does not appear flat (even when selecting ALL CH ADJ in the Auto MCACC Setup) due to adjustments made to compensate for room characteristics to achieve optimal sound. Areas of the graph may appear identical (before and after) when there is little or no adjustment needed. The graph may appear to have shifted vertically when comparing before and after measurements.
EQ adjustments made using the <i>Manual MCACC setup</i> on page 106 do not appear to change the graphical output.	<ul style="list-style-type: none"> Despite level adjustments being made, the filters used for analysis may not display these adjustments in the graphical output. However, these adjustments are taken into account by the filters dedicated to overall system calibration.
Lower frequency response curves do not seem to have been calibrated for SMALL speakers.	<ul style="list-style-type: none"> Low frequencies used in bass management (the subwoofer channel) will not change for speakers that have been specified as SMALL in the configuration, or do not output these frequencies. Calibration is performed, but due to your speakers' low frequency limitations, no measurable sound is output for display.

Display

Symptom	Remedy
The display is dark or off.	<ul style="list-style-type: none"> Press DIMMER repeatedly to select a different brightness.
You can't get DIGITAL to display when using SIGNAL SEL .	<ul style="list-style-type: none"> Check the digital connections and make sure that the digital inputs are assigned correctly (see <i>The Input Setup menu</i> on page 45). If the multichannel analog inputs are selected, select a different input function.
Ⓜ DIGITAL or DTS does not light when playing Dolby/DTS software.	<ul style="list-style-type: none"> These indicators do not light if playback is paused. Check the playback (especially the digital output) settings of the source component.
When playing Dolby Digital or DTS sources, the receiver's format indicators do not light.	<ul style="list-style-type: none"> Check that the player is connected using a digital connection. Make sure that the receiver is set to AUTO or DIGITAL (see <i>Choosing the input signal</i> on page 62). Check that the player isn't set up so that Dolby Digital and DTS sources are converted to PCM. Ensure that if there are several audio tracks on the disc, the Dolby Digital or DTS is selected.
When playing certain discs, none of the receiver's format indicators light.	<ul style="list-style-type: none"> The disc may not contain 5.1/6.1 channel material. Check the disc packaging for more on what audio tracks are recorded on the disc.
When playing a disc with the listening mode set to Auto Surround or ALC, Ⓜ PL II or Neo:6 appear on the receiver.	<ul style="list-style-type: none"> Make sure that the receiver is set to AUTO or DIGITAL (see <i>Choosing the input signal</i> on page 62). If a two channel soundtrack is currently playing (including Dolby Surround encoded), then this is not a malfunction. Check the disc packaging for details about the audio tracks available.
During playback of DVD-Audio, the display shows PCM .	<ul style="list-style-type: none"> This will occur when playing DVD-Audio material over the HDMI connection. This is not a malfunction.
The power turns off automatically and some indicator flashes, or some indicator flashes and the power does not turn on.	<ul style="list-style-type: none"> See the Power section (page 122).

Remote control

Symptom	Remedy
Cannot be remote controlled.	<ul style="list-style-type: none"> Set the remote control unit's remote control mode so that it matches the setting on the main unit (see <i>Operating multiple receivers</i> on page 84 (SC-37)/page 96 (SC-35)). Check whether the receiver's remote control mode is properly set (see <i>Remote Control Mode Setup</i> on page 119). Try replacing the batteries in the remote control (see <i>Loading the batteries</i> on page 10). Be sure to operate within 7 m (23 feet) and a 30° angle of the remote sensor on the front panel (see <i>Operating range of remote control unit</i> on page 11). Check that there are no obstacles between the receiver and the remote control. Make sure that there is no fluorescent or other strong light shining on to the remote sensor. Check the connections of the CONTROL IN jacks (see <i>Operating other Pioneer components with this unit's sensor</i> on page 41).
<i>SC-37 only:</i> Input does not switch to Sirius or XM when OPTION 1 or OPTION 2 button is pressed.	<ul style="list-style-type: none"> Sirius and XM operations can no longer be performed if other preset codes are assigned to the OPTION 1 (Sirius) or OPTION 2 (XM) button. In this case, reset the OPTION 1 or OPTION 2 button (see <i>Resetting the input assignment of one of the input function buttons</i> on page 86).
<i>SC-37 only:</i> Receiver or other components cannot be operated by RF two-way communications.	<ul style="list-style-type: none"> There may be radio interference with other devices. Try increasing the distance from microwave ovens, devices on a wireless LAN, other wireless devices, etc. (see <i>Precautions when using the Omni-Directional RF Remote Control</i> on page 94). Try replacing the batteries in the remote control (see <i>Loading the batteries</i> on page 10). If the RF adapter's LED is off, the RF adapter may not be properly connected to the receiver. Check whether the RF adapter is properly connected to the receiver (see <i>Connecting the RF adapter (SC-37 only)</i> on page 21). The devices may no longer be properly paired. Pair them again (see <i>Pairing the RF adapter and remote control</i> on page 92). When the remote control or main unit are reset, the RF communications function is also reset. Make the settings again (see <i>Using the RF communications function</i> on page 91).
<i>SC-37 only:</i> The remote control display flickers.	<ul style="list-style-type: none"> Flickering may occur when the remaining battery power is low. Replace the batteries with new ones (see <i>Loading the batteries</i> on page 10).
Other components can't be operated with the system remote.	<ul style="list-style-type: none"> If the battery ran down, the preset codes may have been cleared. Re-enter the preset codes. The preset code may be incorrect. Redo the procedure for entering preset codes. When commands from the remote control units of other devices are registered using the learning function, in some cases they may not be learned properly. In this case, register the commands again using the learning function (see <i>Programming signals from other remote controls</i> on page 85 (SC-37) / page 97 (SC-35)). If they still do not work, they may be in a special format that cannot be registered on this receiver's remote control. Operate the device using another remote control.

Web Control

Symptoms	Causes	Remedies
Top Menu screen is not displayed on browser.	This receiver's IP address has not been entered into the browser correctly.	Check the receiver's IP address and enter it correctly in the browser (page 117).
Receiver cannot be operated from browser.	JavaScript is disabled on the internet browser.	Enable JavaScript.
	The browser is not compatible with JavaScript.	Use an internet browser that is compatible with JavaScript.
Receiver's power does not turn on when the power is turned on using the Web Control function.	Network Standby at Network Setup is set to OFF .	Set Network Standby at Network Setup to ON (page 118).

HDMI

Symptom	Remedy
The HDMI indicator blinks continuously.	<ul style="list-style-type: none"> • Check all the points below.
No picture or sound.	<ul style="list-style-type: none"> • This receiver is HDCP-compatible. Check that the components you are connecting are also HDCP-compatible. If they are not, please connect them using the component or composite video jacks. • Depending on the connected source component, it's possible that it will not work with this receiver (even if it is HDCP-compatible). In this case, connect using the component or composite video jacks between source and receiver. • If the problem still persists when connecting your HDMI component directly to your monitor, please consult the component or monitor manual or contact the manufacturer for support. • If video images do not appear on your TV, try adjusting the resolution, DeepColor or other setting for your component. • While analog video signals are being output over HDMI, use a separate connection for audio output. • To output signals in DeepColor, use an HDMI cable (High Speed HDMI® Cable) to connect this receiver to a component or TV with the DeepColor feature.
No picture.	<ul style="list-style-type: none"> • Try changing the Resolution setting (in <i>Setting the Video options</i> on page 78). • Set the HDMI output setting to the connected HDMI OUT terminal (in <i>Switching the HDMI output</i> on page 81).
No sound, or sound suddenly ceases.	<ul style="list-style-type: none"> • Check that the HDMI AV setting is set to AMP/THROUGH. • If the component is a DVI device, use a separate connection for the audio. • If analog video is being output over HDMI, please use a separate connection for the audio. • Check the audio output settings of the source component. • HDMI format digital audio transmissions require a longer time to be recognized. Due to this, interruption in the audio may occur when switching between audio formats or beginning playback. • Turning on/off the device connected to this unit's HDMI OUT terminal during playback, or disconnecting/connecting the HDMI cable during playback, may cause noise or interrupted audio.
Noisy or distorted picture.	<ul style="list-style-type: none"> • Sometimes a video deck may output a noisy video signal (during scanning, for example), or the video quality may just be poor (with some video game units, for example). The picture quality may also depend on the settings, etc. of your display device. Switch off the video converter and reconnect the source and display device using the same type of connection (component or composite), then start playback again. • If the problem still persists when connecting your HDMI component directly to your monitor, please consult the component or monitor manual or contact the manufacturer for support.
HDCP ERROR shows in the display.	<ul style="list-style-type: none"> • Check whether or not the connected component is compatible with HDCP. If it is not compatible with HDCP, reconnect the source device using a different type of connection (component or composite). Some components that are compatible with HDCP still cause this message to be displayed, but so long as there is no problem with displaying video, this is not a malfunction.
When Control with HDMI is set to ON , the HDMI Input assignment at Input Setup is canceled.	<ul style="list-style-type: none"> • Even when Control with HDMI is set to ON, for Digital In assignment of HDMI 1 is not canceled, so in this case use the HDMI 1 input.
Synchronized operation not possible using Control with HDMI function.	<ul style="list-style-type: none"> • Check the HDMI connections. • The cable may be damaged. • Select ON for the Control with HDMI setting (see <i>HDMI Setup</i> on page 73). • Select ALL for the Control Mode with HDMI setting (see <i>HDMI Setup</i> on page 73). • Turn the TV's power on before turning on this receiver's power. • Set the TV side Control with HDMI setting to on (see TV's operating instructions). • Connect the TV to the HDMI OUT 1 terminal and set the HDMI output to HDMI OUT 1. Then turn on first the TV's power, then this receiver's power.

Important information regarding the HDMI connection

There are cases where you may not be able to route HDMI signals through this receiver (this depends on the HDMI-equipped component you are connecting—check with the manufacturer for HDMI compatibility information).

If you aren't receiving HDMI signals properly through this receiver (from your component), please try one of the following configurations when connecting up.

Configuration A

Use component video cables to connect the video output of your HDMI-equipped component to the receiver's component video input. The receiver can then convert the analog component video signal to a digital HDMI signal for transmission to the display. For this configuration, use the most convenient connection (digital is recommended) for sending audio to the receiver. See the operating instructions for more on audio connections.



Note

- The picture quality will change slightly during conversion.

Configuration B

Connect your HDMI-equipped component directly to the display using an HDMI cable. Then use the most convenient connection (digital is recommended) for sending audio to the receiver. See the operating instructions for more on audio connections. Set the display volume to minimum when using this configuration.



Note

- If your display only has one HDMI terminal, you can only receive HDMI video from the connected component.
- Depending on the component, audio output may be limited to the number of channels available from the connected display unit (for example audio output is reduced to 2 channels for a monitor with stereo audio limitations).
- If you want to switch the input function, you'll have to switch functions on both the receiver and your display unit.
- Since the sound is muted on the display when using the HDMI connection, you must adjust the volume on the display every time you switch input functions.

USB interface

Symptoms	Causes	Remedies
The folders/files stored on a USB memory device are not displayed.	The folders/files are currently stored in a region other than the FAT (File Allocation Table) region.	Store the folders/files in the FAT region.
	The number of levels in a folder is more than 8.	Limit the maximum number of levels in a folder to 8 (page 49).
	There are more than 30 000 folders/files stored in a USB memory device.	Limit the maximum number of folders/files stored in a USB memory device to 30 000 (page 49).
A USB memory device is not recognized.	The audio files are copyrighted.	Copyrighted audio files stored on a USB memory device cannot be played back (page 49).
	The USB memory device does not support the mass storage class specifications.	Try using a USB memory device compatible with the mass storage class specifications. Note that there are cases where even the audio files stored on a USB memory device compatible with the mass storage class specifications are not played back on this receiver (page 49).
		Connect the USB memory device and switch on this receiver (page 40).
	A USB hub is currently being used.	This receiver does not support USB hubs (page 49).
	This receiver recognizes the USB memory device as a fraud.	Switch off and on again this receiver.

Symptoms	Causes	Remedies
A USB memory device is connected and displayed, but the audio files stored on the USB memory device cannot be played back.	Some formats of USB memory devices, including FAT 12, NTFS, and HFS, cannot be played back on this receiver.	Check whether the format of your USB memory device is either FAT 16 or FAT 32. Note that the FAT 12, NTFS, and HFS formats cannot be played back on this receiver (page 49).
	The file format cannot be properly played back on this receiver.	See the list of file formats that can be played back on this receiver (page 51).
Cannot detect USB keyboard.	The USB keyboard is routed through a USB hub.	This receiver is not compatible with USB hubs. Plug the keyboard directly into the receiver.
	A PS2 keyboard is routed through a PS2/USB connector.	PS2 keyboards cannot be used with this receiver, even if routed through a PS2/USB connector. Use a USB keyboard.
	Keyboard is not a USB HID Class device.	Some devices will not be detected. Use a USB HID Class keyboard.
Cannot enter correct text using the USB keyboard.	Keyboard is not US-international layout keyboard.	Use a US-international layout keyboard. NB: Some characters cannot be entered.

Internet radio (SC-35 only)

Symptoms	Causes	Remedies
Cannot access the network. ("Connection Error" shows in the display.)	The LAN cable is not firmly connected.	Firmly connect the LAN cable (page 38).
	The router is not switched on.	Switch on the router.
	The network device was switched on when this receiver was already on.	Switch the network device on before the receiver.
Cannot listen to Internet radio stations. ("Connection Error" shows in the display.)	The firewall settings for components on the network are currently in operation.	Check the firewall settings for components on the network.
	You are currently disconnected from the Internet.	Check the connection settings for components on the network, and consult with your network service provider if necessary (page 117).
	The URL for the Internet radio station is incorrectly programmed.	Check that the URL was correctly entered when programming.
	The broadcasts from an Internet radio station are stopped or interrupted.	Broadcasts may be interrupted or suspended by the radio station.
	An Internet radio station is selected whose protocol this receiver does not recognize.	This receiver does not recognize protocols other than 'http' and 'mms'.
	An Internet radio station had closed or moved.	Enter new internet radio station on the Internet Radio Setup.
Cannot listen to Internet radio stations. ("File Format Error" shows in the display.)	Broadcast is in a format not compatible with this receiver.	This receiver cannot play audio in formats other than MP3 or WMA. Also, even if they are MP3 or WMA formats, this receiver may not be able to play back.
The Internet radio settings screen cannot be displayed on the computer Internet browser.	This receiver's IP address has not been entered into the browser correctly.	Check the receiver's IP address and enter it correctly on the browser (page 117).
	JavaScript is disabled on the Internet browser.	Enable JavaScript.
	The browser is not compatible with JavaScript.	Use an Internet browser that is compatible with JavaScript.

XM radio messages

Status messages	Cause	Action
Check XM Tuner	The XM Mini-Tuner is not installed or not fully seated in the XM Mini-Tuner Home Dock or the XM Mini-Tuner Dock is not connected to this receiver.	Confirm the XM Mini-Tuner is fully seated in the dock and check the XM Mini-Tuner Home Dock cable is connected to this receiver.

Status messages	Cause	Action
Check Antenna	The XM antenna is not connected to the XM Mini-Tuner Home Dock or the XM antenna cable is damaged.	Check that the XM antenna is securely connected to the XM Mini-Tuner Home Dock and check the antenna cable for damage. Replace the XM antenna if the cable is damaged.
Loading	The XM Mini-Tuner is acquiring audio or program information from the XM satellite signal. This message can also occur in weak XM signal conditions. Note that this receiver may not respond to some buttons while this message is displayed.	This message should disappear in a few seconds in good signal conditions. If you see this message often, reposition the XM antenna for better signal reception. Use the Antenna Aiming option to optimize the antenna position.
No Signal	The XM Mini-Tuner is not receiving the XM satellite signal. Something may be blocking the XM antenna's view of the satellites or the antenna is not properly aimed.	Check for antenna obstructions and reposition the XM antenna to get better signal reception. Use the Antenna Aiming option to optimize the antenna position. See instructions supplied with the XM Mini-Tuner and Home Dock for antenna installation information.
Off Air	The XM channel you selected is not currently broadcasting.	Check back later.
CH Unauthorized	You selected an XM channel that is blocked or cannot be received with your XM subscription package.	Consult the latest channel guide at www.xmradio.com for the current list of channels. For information on receiving this channel, visit www.xmradio.com or contact XM Satellite Radio at 1-800-967-2346.
CH Unavailable	The selected channel is not available. The channel may have been reassigned to a different channel number. This message may occur initially with a new radio or a radio that has not received XM's signal for an extended period.	Consult the latest channel guide at www.xmradio.com for the current list of channels. For cases of a new radio or a radio that has not received XM's signal for an extended period, allow the radio to receive the XM satellite signal for at least 5 minutes and then try to select the channel again.
-----	No artist name or song title is available for this selection.	No action required.
Upgrade XM Tuner	The connected XM CNP-1000 is incompatible. This receiver features advanced technology that is designed for use with the XM Mini-Tuner.	Contact XM Listener Care (1-800-967-2346) and ask about upgrading your XM CNP-1000 to an XM Mini-Tuner. Have this receiver's model name and CNP-1000 XM Radio ID number ready beforehand, and explain that this receiver is displaying the message Upgrade XM Tuner . If you already have an XM Mini-Tuner connected and you see this message, turn off this receiver, make sure the XM Mini-Tuner is properly seated in the Mini-Tuner Home Dock, and then turn this receiver on again. If the message reappears, contact XM Listener Care and explain the issue that you're experiencing and the corrective actions you've tried.
XM Power Error	A short-circuit occurring in the antenna or surrounding antenna cable.	Make sure that there is nothing unusual with the antenna or antenna cable. Switch the power off, then back on again.

SIRIUS radio messages

Status messages	Cause	Action
Antenna Error	The SIRIUS antenna is not properly connected.	Check that the antenna cable is attached securely.

Status messages	Cause	Action
Check Sirius Tuner	The SiriusConnect™ tuner is not properly connected.	Check that the 8 pin mini DIN cable and AC Adapter are attached securely.
Acquiring Signal	The SIRIUS signal is too weak at the current location.	Check for antenna obstructions and reposition the SIRIUS antenna to get better signal reception. Use the Antenna Aiming option to optimize the antenna position.
Subscription Updating	Unit is updating subscription.	Wait until the channel subscription has been updated.
Updating Channels	Unit is updating the channel information.	Wait until the channel information has been updated.
Invalid Channel	Selected channel is not available/does not exist.	Select another channel.
Firmware Updating	The SiriusConnect™ tuner's firmware is being updated.	Wait for updating to finish.

HOME MEDIA GALLERY *(SC-37 only)*

Symptoms	Causes	Remedies
Cannot access the network.	The LAN cable is not firmly connected.	Firmly connect the LAN cable (page 38).
	The router is not switched on.	Switch on the router.
	Internet security software is currently installed in the connected component.	There are cases where a component with Internet security software installed cannot be accessed.
	The audio component on the network which has been switched off is switched on.	Switch on the audio component on the network before switching on this receiver.
Playback does not start while 'Connecting...' continues to be displayed.	The component is currently disconnected from this receiver or the power supply.	Check whether the component is properly connected to this receiver or the power supply.
The PC or Internet radio is not properly operated.	The corresponding IP address is not properly set.	Switch on the built-in DHCP server function of your router, or set up the network manually according to your network environment (page 117).
	The IP address is being automatically configured.	The automatic configuration process takes time. Please wait.
The audio files stored on components on the network, such as a PC, cannot be played back.	Windows Media Player 11 or Windows Media Player 12 is not currently installed on your PC.	Install Windows Media Player 11 or Windows Media Player 12 on your PC (page 64).
	Audio files were recorded in formats other than MP3, WAV (LPCM only), MPEG-4 AAC, FLAC, and WMA.	Play back audio files recorded in MP3, WAV (LPCM only), MPEG-4 AAC, FLAC, or WMA. Note that some audio files recorded in these formats may not be played back on this receiver.
	Audio files recorded in MPEG-4 AAC or FLAC are being played back on Windows Media Player 11 or Windows Media Player 12.	Audio files recorded in MPEG-4 AAC or FLAC cannot be played back on Windows Media Player 11 or Windows Media Player 12. Try using another server. Refer to the operation manual supplied with your server.
	The component connected to the network is not properly operated.	Check whether the component is affected by special circumstances or is in the sleep mode. Try rebooting the component if necessary.
	The component connected to the network does not permit file sharing.	Try changing the settings for the component connected to the network.
	The folder stored on the component connected to the network has been deleted or damaged.	Check the folder stored on the component connected to the network.

Symptoms	Causes	Remedies
Cannot access the component connected to the network.	The component connected to the network is not properly set.	If the client is automatically authorized, you need to enter the corresponding information again. Check whether the connection status is set to "Do not authorize".
	There are no playable audio files on the component connected to the network.	Check the audio files stored on the component connected to the network.
Audio playback is undesirably stopped or disturbed.	The audio file currently being played back was not recorded in a format playable on this receiver.	Check whether the audio file was recorded in a format supported by this receiver. Check whether the folder has been damaged or corrupted. Note that there are cases where even the audio files listed as playable on this receiver cannot be played back or displayed (page 70).
	The LAN cable is currently disconnected.	Connect the LAN cable properly (page 38).
	There is heavy traffic on the network with the Internet being accessed on the same network.	Use 100BASE-TX to access the components on the network.
	When in the DMR mode, depending on the external controller being used, playback may be interrupted when a volume operation is performed from the controller.	In this case, adjust the volume from the receiver or remote control.
Cannot access Windows Media Player 11 or Windows Media Player 12.	<i>In case of Windows Media Player 11:</i> You are currently logged onto the domain through your PC with Windows XP or Windows Vista installed. <i>In case of Windows Media Player 12:</i> You are currently logged onto the domain through your PC with Windows 7 installed.	Instead of logging onto the domain, log onto the local machine (page 65).
Cannot listen to Internet radio stations	The firewall settings for components on the network are currently in operation.	Check the firewall settings for components on the network.
	You are currently disconnected from the Internet.	Check the connection settings for components on the network, and consult with your network service provider if necessary (page 117).
	The broadcasts from an Internet radio station are stopped or interrupted.	There are cases where you cannot listen to some Internet radio stations even when they are listed in the list of Internet radio stations on this receiver (page 66).
The Home Media Gallery cannot be operated with the buttons on the remote control.	The remote control is not currently set to the Home Media Gallery mode.	Press HMG to set the remote control to the Home Media Gallery mode (page 65).

About status messages (SC-37 only)

Refer to the following information when you come up with a status message while operating the Home Media Gallery.

Status messages	Descriptions
STARTING H.M.G.	A component on the network, including a PC, is currently being connected. Wait for a while.
Connection Down	The selected category or Internet radio station cannot be accessed.
File Format Error	Cannot be played back for some reasons.
Track Not Found	The selected song has not been found anywhere on the network.
Server Error	The selected server cannot be accessed.
Server Disconnected	The server has been disconnected.
empty	There are no files stored in the selected folder.
Preset Not Stored	The selected Internet radio station is not currently registered and saved.
Out of Range	The value entered is beyond the permitted range of the network settings.
License Error	The license for the contents to be played back is invalid.

Status messages	Descriptions
Item Already Exists	This is displayed when the file you have attempted to register in the Favorites folder has already been registered.
Favorite List Full	This is displayed when you have attempted to register a file in the Favorites folder but the Favorites folder is already full.

If the problem is not solved after the troubleshooting above, if the screen freezes unexpectedly or if the buttons on the remote control or front panel stop working completely, do the following:

- Press **⏻ STANDBY/ON** on the front panel to turn off the power, then turn the power back on.
- If the power cannot be turned off, press and hold **⏻ STANDBY/ON** on the front panel for over 10 seconds. The power will turn off. (In this case, the various settings made on the receiver may be cleared.)

Surround sound formats

Below is a brief description of the main surround sound formats you'll find on BDs, DVDs, satellite, cable and terrestrial broadcasts, and video cassettes.

Dolby

The Dolby technologies are explained below. See www.dolby.com for more detailed information.



Manufactured under license from Dolby Laboratories. Dolby, Pro Logic, Surround EX and the double-D symbol are trademarks of Dolby Laboratories.

DTS

The DTS technologies are explained below. See www.dtstech.com for more detailed information.



Manufactured under license under U.S. Patent #'s: 5,451,942; 5,956,674; 5,974,380; 5,978,762; 6,226,616; 6,487,535; 7,212,872; 7,333,929; 7,392,195; 7,272,567 & other U.S. and worldwide patents issued & pending. DTS and the Symbol are registered trademarks, & DTS-HD, DTS-HD Master Audio, and the DTS logos are trademarks of DTS, Inc. Product includes software. © DTS, Inc. All Rights Reserved.

Windows Media Audio 9 Professional

Windows Media Audio 9 Professional (WMA9 Pro) is a discrete surround format developed by Microsoft Corporation.



Windows Media and the Windows logo are trademarks or registered trademarks of Microsoft Corporation in the United States and/or other countries.

About THX

The THX technologies are explained below. See www.thx.com for more detailed information.

In case of SC-37



In case of SC-35



• THX Cinema processing

THX is an exclusive set of standards and technologies established by THX Ltd. THX grew from George Lucas' personal desire to make your experience of the film soundtrack, in both movie theatres and in your home theatre, as faithful as possible to what the director intended. Movie soundtracks are mixed in special movie theatres called dubbing stages and are designed to be played back in movie theatres with similar equipment and conditions. This same soundtrack is then transferred directly onto Laserdisc, VHS tape, DVD, etc., and is not changed for playback in a small home theatre environment. THX engineers developed patented technologies to accurately translate the sound from the movie theatre environment into the home.

correcting the tonal and spatial errors that occur. On this product, when the THX indicator is on, THX features are automatically added in Cinema modes (e.g. THX Cinema, THX Surround EX).

- **Re-Equalization**

The tonal balance of a film soundtrack will be excessively bright and harsh when played back over audio equipment in the home because film soundtracks were designed to be played back in large movie theaters using very different professional equipment. Re-Equalization restores the correct tonal balance for watching a movie soundtrack in a small home environment.

- **Timbre Matching**

The human ear changes our perception of a sound depending on the direction from which the sound is coming. In a movie theatre, there is an array of surround speakers so that the surround information is all around you. In a home theatre, you use only two speakers located to the side of your head. The Timbre Matching feature filters the information going to the surround speakers so that they more closely match the tonal characteristics of the sound coming from the front speakers. This ensures seamless panning between the front and surround speakers.

- **Adaptive Decorrelation**

In a movie theatre, a large number of surround speakers help create an enveloping surround sound experience, but in a home theatre there are usually only two speakers. This can make the surround speakers sound like headphones that lack spaciousness and envelopment. The surround sounds will also collapse into the closest speaker as you move away from the middle seating position. Adaptive Decorrelation slightly changes one surround channel's time and phase relationship with respect to the other surround channel. This expands the listening position and creates—with only two speakers—the same spacious surround experience as in a movie theatre.

- **THX Ultra2/Select2 Plus**

Before any home theatre component can be THX Ultra2/Select2 Plus certified, it must incorporate all the features above and also pass a rigorous series of quality and performance tests. Only then can a product feature the THX Ultra2/Select2 Plus logo, which is your guarantee that the Home Theatre products you purchase will give you superb performance for many years to come. THX Ultra2/Select2 Plus requirements cover every aspect of the product including pre-amplifier and power amplifier performance and operation, and hundreds of other parameters in both the digital and analog domain.

- **THX Surround EX**

THX Surround EX - Dolby Digital Surround EX is a joint development of Dolby Laboratories and the THX Ltd. In a movie theater, film soundtracks that have been encoded with Dolby Digital Surround EX technology are able to reproduce an extra channel which has been added during the mixing of the program. This channel, called Surround Back, places sounds behind the listener in addition to the currently available front left, front center, front right, surround right, surround left and subwoofer channels. This additional channel provides the opportunity for more detailed imaging behind the listener and brings more depth, spacious ambience and sound localization than ever before. Movies that were created using the Dolby Digital Surround EX technology, when released into the home consumer market may exhibit wording to that effect on the packaging. A list of movies created using this technology can be found on the Dolby web site at www.dolby.com.

Only amplifier and controller products bearing the THX Surround EX logo, when in the THX Surround EX mode, faithfully reproduce this new technology in the home.

This product may also engage the "THX Surround EX" mode during the playback of 5.1 channel material that is not Dolby Digital Surround EX encoded. In such case the information delivered to the Surround Back channel will be program dependent and may or may not be very pleasing depending on the particular soundtrack and the tastes of the individual listener.

- **Boundary Gain Compensation™**

Depending on the listener's and the subwoofer's position, the listener may experience an excessive bass effect. This feature compensates for excessive bass resulting from a boundary gain effect. This feature is designed to operate when used with a subwoofer certified to THX Ultra2/Select2™ specifications.

- **THX Loudness Plus Description**

THX Loudness Plus is a new volume control technology featured in THX Ultra2 Plus™ and THX Select2 Plus™ Certified amplifiers. With THX Loudness Plus, home theater audiences can now experience the rich details in a surround mix at any volume level. A consequence of turning the volume below Reference Level is that certain sound elements can be lost or perceived differently by the listener. THX Loudness Plus compensates for the tonal and spatial shifts that occur when the volume is reduced by intelligently adjusting ambient surround channel levels and frequency response. This enables users to experience the true impact of soundtracks regardless of the volume setting. THX Loudness Plus is automatically applied when listening in any THX listening mode. The new THX Cinema, THX Music, and THX Games modes are tailored to apply the proper THX Loudness Plus settings for each type of content.

- **ASA Description**

ASA is a proprietary THX technology which processes the sound fed to 2 side and 2 back surround speakers to provide the optimal surround sound experience. When you set up your home theater system using all eight speaker outputs (Left, Center, Right, Surround Right, Surround Back Right, Surround Back Left, Surround Left and Subwoofer), be sure to go to the THX Audio Set-up screen and choose the setting that most closely corresponds to the speaker spacing, which will re-optimize the surround sound-field. ASA is used in three modes: THX Ultra2 Cinema, THX Ultra2 Music and THX Ultra2 Games.

- **THX Ultra2/Select2 Cinema**

THX Ultra2/Select2 Cinema mode plays 5.1 movies using all 8 speakers giving you the best possible movie watching experience. In this mode, ASA processing blends the side surround speakers and back surround speakers providing the optimal mix of ambient and directional surround sounds. DTS-ES (Matrix and 6.1 Discrete) and Dolby Digital Surround EX encoded soundtracks will be automatically detected in Ultra2/Select2 Cinema mode if the appropriate flag has been encoded.

Some Dolby Digital Surround EX soundtracks are missing the digital flag that allows automatic switching. If you know that the movie that you are watching is encoded in Surround EX, you can manually select the THX Surround EX playback mode, otherwise THX Ultra2/Select2 Cinema mode will apply ASA processing to provide optimum replay.

- **THX Ultra2/Select2 Music**

For the playback of multi-channel music the THX Ultra2/Select2 Music mode should be selected. In this mode THX ASA processing is applied to the surround channels of all 5.1 encoded music sources such as DTS, Dolby Digital and DVD-Audio to provide a wide stable rear soundstage.

- **THX Ultra2/Select2 Games**

For the playback of stereo and multi-channel game audio the THX Ultra2/Select2 Games mode should be selected. In this mode THX ASA processing is applied to the surround channels of all 5.1 and 2.0 encoded game sources such as analog, PCM, DTS and Dolby Digital. This accurately places all game audio surround information, providing a full 360 degree playback environment. THX Ultra2/Select2 Games mode is unique as it gives you a smooth transition of audio in all points of the surround field.

THX, the THX logo, Ultra2 Plus and Select2 Plus are trademarks of THX Ltd. which may be registered in some jurisdictions. All rights reserved. All other trademarks are the property of their respective owners.

About iPod



“Made for iPod” means that an electronic accessory has been designed to connect specifically to iPod and has been certified by the developer to meet Apple performance standards.

“Works with iPhone” means that an electronic accessory has been designed to connect specifically to iPhone and has been certified by the developer to meet Apple performance standards.

Apple is not responsible for the operation of this device or its compliance with safety and regulatory standards.

iPod is a trademark of Apple Inc., registered in the U.S. and other countries.

iPhone is a trademark of Apple Inc.

About SIRIUS and XM



SIRIUS, XM and all related marks and logos are trademarks of Sirius XM Radio Inc. and its subsidiaries. All other marks and logos are the property of their respective owners. All rights reserved. SIRIUS and XM subscriptions sold separately. Taxes and a one-time activation fee may apply. XM tuners and home docks or SIRIUS tuners (each sold separately) are required to receive the SIRIUS or XM satellite radio service. All programming and fees subject to change. It is prohibited to copy, decompile, disassemble, reverse engineer, hack, manipulate or otherwise make available any technology or software incorporated in receivers compatible with the SIRIUS or XM Satellite Radio Systems. Service not available in Alaska and Hawaii.

SIRIUS, XM and all related marks and logos are trademarks of Sirius XM Radio Inc. and its subsidiaries. All rights reserved. Service not available in Alaska and Hawaii.

Record the SiriusConnect™ tuner ID below for reference.

Record the XM Radio ID below for reference.

Note: The XM Radio ID does not use the letters “I”, “O”, “S” or “F”.

About FLAC

FLAC Decoder

Copyright © 2000, 2001, 2002, 2003, 2004, 2005, 2006, 2007 Josh Coalson

Redistribution and use in source and binary forms, with or without modification, are permitted provided that the following conditions are met:

- Redistributions of source code must retain the above copyright notice, this list of conditions and the following disclaimer.
- Redistributions in binary form must reproduce the above copyright notice, this list of conditions and the following disclaimer in the documentation and/or other materials provided with the distribution.
- Neither the name of the Xiph.org Foundation nor the names of its contributors may be used to endorse or promote products derived from this software without specific prior written permission.

THIS SOFTWARE IS PROVIDED BY THE COPYRIGHT HOLDERS AND CONTRIBUTORS “AS IS” AND ANY EXPRESS OR IMPLIED WARRANTIES, INCLUDING, BUT NOT LIMITED TO, THE IMPLIED WARRANTIES OF MERCHANTABILITY AND FITNESS FOR A PARTICULAR PURPOSE ARE DISCLAIMED. IN NO EVENT SHALL THE FOUNDATION OR CONTRIBUTORS BE LIABLE FOR ANY DIRECT, INDIRECT, INCIDENTAL, SPECIAL, EXEMPLARY, OR CONSEQUENTIAL DAMAGES (INCLUDING, BUT NOT LIMITED TO, PROCUREMENT OF SUBSTITUTE GOODS OR SERVICES; LOSS OF USE, DATA, OR PROFITS; OR BUSINESS INTERRUPTION) HOWEVER CAUSED AND ON ANY THEORY OF LIABILITY, WHETHER IN CONTRACT, STRICT LIABILITY, OR TORT (INCLUDING NEGLIGENCE OR OTHERWISE) ARISING IN ANY WAY OUT OF THE USE OF THIS SOFTWARE, EVEN IF ADVISED OF THE POSSIBILITY OF SUCH DAMAGE.

Auto Surround, ALC and Stream Direct with different input signal formats

The following charts show what you will hear with different input signal formats, depending on the Stream Direct mode (see *Using Stream Direct* on page 62) you have selected.

Stereo (2 channel) signal formats

Input signal format	Auto Surround / ALC / DIRECT	PURE DIRECT
Surround Back speaker(s): Connected		
Dolby Digital Surround	⏏ Pro Logic IIx MOVIE	⏏ Pro Logic IIx MOVIE
DTS Surround	Neo:6 CINEMA	Neo:6 CINEMA
Other stereo sources	Stereo playback	Stereo playback
Analog sources	As above	ANALOG DIRECT (stereo)
PCM sources	As above	PCM DIRECT
DVD-A sources	As above	As above
SACD sources	As above	As above
Surround Back speaker(s): Not connected		
Dolby Digital Surround	⏏ Pro Logic II MOVIE	⏏ Pro Logic II MOVIE
DTS Surround	Neo:6 CINEMA	Neo:6 CINEMA
Other stereo sources	Stereo playback	Stereo playback
Analog sources	As above	ANALOG DIRECT (stereo)
PCM sources	As above	PCM DIRECT
DVD-A sources	As above	As above
SACD sources	As above	As above

Multichannel signal formats

Input signal format	Auto Surround / ALC	PURE DIRECT / DIRECT
Surround Back speaker(s): Connected		
Dolby Digital EX (6.1 channel flagged)	Dolby Digital EX ⏏ Pro Logic IIx MOVIE ^a	Dolby Digital EX ⏏ Pro Logic IIx MOVIE ^a
DTS-ES (6.1 channel sources/6.1 channel flagged)	DTS-ES (Matrix/Discrete)	DTS-ES (Matrix/Discrete)
DTS sources (5.1 channel encoding)	Straight decoding	Straight decoding
DTS-HD sources	As above	As above
Other 5.1/6.1/7.1 channel sources	As above	As above
Surround Back speaker(s): Not connected		
DVD-A sources/Multi-ch PCM	Straight decoding	Straight decoding
SACD sources (5.1 channel encoding)	As above	As above
Other 5.1/6.1/7.1 channel sources	As above	As above

a.Unavailable with only one surround back speaker connected.

Preset code list (SC-35 only)

You should have no problem controlling a component if you find the manufacturer in this list, but please note that there are cases where codes for the manufacturer in the list will not work for the model that you are using. There are also cases where only certain functions may be controllable after assigning the proper preset code.

Important

- We do not guarantee the operations of all the manufacturers and devices listed. Operation may not be possible even if a preset code is entered.
If you can't find a preset code that matches the component you want to control, you can still teach the remote individual commands from another remote control (see *Programming signals from other remote controls* on page 97).

example:

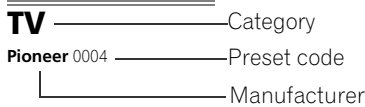

TV

Pioneer 0004, 0006, 0113, 0115, 0116, 0117, 0119, 0122, 0123	Curtis Mathes 0000, 0004, 0006, 0014, 0100, 0101	Hitachi 0004, 0006, 0007	Motorola 0003, 0014
Admiral 0001, 0014	CXC 0008, 0104	Hyundai 0098	MTC 0004, 0005, 0006, 0100
Adventura 0012	Cytron 0093	Ilo 0089, 0091	Multitech 0008, 0104, 0110
Aiwa 0002	Daewoo 0004, 0005, 0006, 0023	IMA 0008	NAD 0006, 0102
Akai 0002, 0100	Daytron 0004, 0006	Infinity 0101	NEC 0003, 0004, 0005, 0006, 0100
Albatron 0097	Dell 0073	InFocus 0074	Net-TV 0107
Alleron 0009	DiamondVision 0096	Initial 0091	Nikko 0006, 0100
America Action 0104	Dimensia 0000	Insighia 0085, 0086	Norcent 0060
Amtron 0008	Disney 0046	Inteq 0099	Olevia 0048, 0054, 0059
Anam 0104	Dumont 0004, 0011, 0099	Janeil 0012	Onwa 0008, 0104
Anam National 0003, 0008	Durabrand 0041, 0103, 0104	JBL 0101	Oppo 0095
AOC 0004, 0005, 0006, 0100	Dwin 0014	JC Penney 0000, 0004, 0005, 0006, 0010	Optimus 0105
Apex 0021, 0102, 0106	Electroband 0002	JCB 0002	Optoma 0075
Audiovox 0008, 0104	Electrograph 0107	Jensen 0004, 0006	Optonica 0014
Aventura 0103	Electrohome 0002, 0003, 0004, 0006	JVC 0007, 0010, 0044, 5064	Orion 0025
Axion 0094	Element 0082	Kawasho 0002, 0004, 0006	Panasonic 0003, 0010, 0017, 0027, 0105, 0114, 0120, 0121, 0124, 0125
Bang & Olufsen 0111	Emerson 0004, 0006, 0007, 0008, 0009, 0023, 0103, 0104	KEC 0104	Penney 0100, 0102
Belcor 0004	Emprex 0092	Kenwood 0004, 0006, 0100	Philco 0003, 0004, 0005, 0006, 0007, 0100, 0101
Bell & Howell 0001	Envision 0004, 0006, 0100	KLH 0106	Philips 0003, 0004, 0007, 0019, 0020, 0101
Benq 0064	Epson 0061	Kloss Novabeam 0008, 0012	Philips Magnavox 0019
Bradford 0008, 0104	ESA 0103	KTV 0008, 0100, 0104, 0110	Pilot 0004, 0100
Brilliant 0109	Fujitsu 0009	LG 0005, 0052, 0078, 0097	Polaroid 0057, 0106
Brockwood 0004	Funai 0008, 0009, 0103, 0104	Logik 0001	Portland 0004, 0005, 0006
Broksonic 0104	Futuretech 0008, 0104	LXI 0000, 0006, 0101, 0102	Prima 0065
Candle 0004, 0006, 0012, 0100	Gateway 0067, 0107, 0108	Magnavox 0004, 0006, 0019, 0020, 0037, 0042, 0100, 0101	Princeton 0097
Carnivale 0100	GE 0000, 0003, 0004, 0006, 0010, 0016, 0039	Majestic 0001	Prism 0010
Carver 0101	GFM 0080, 0084	Marantz 0004, 0006, 0062, 0100, 0101	Proscan 0000
CCE 0110	Gibraltar 0004, 0011, 0099, 0100	Matsushita 0105	Proton 0004, 0006, 0007
Celebrity 0002	Goldstar 0004, 0005, 0006, 0007, 0100	Maxent 0087, 0107	Protron 0055
Celera 0106	Gradiente 0066	Megapower 0097	Proview 0068
Changhong 0106	Grunpy 0008, 0009, 0104	Megatron 0006	Pulsar 0004, 0011, 0099
Citizen 0004, 0006, 0008, 0100	Haier 0112	Memorex 0001, 0005, 0006, 0041	Quasar 0003, 0010, 0105
Clarion 0104	Hallmark 0004, 0006	MGA 0004, 0005, 0006, 0100	Radio Shack 0100, 0104
Coby 0056	Harman/Kardon 0101	Midland 0010, 0011, 0099	Radio Shack/Realistic 0000, 0004, 0006, 0007, 0008
Colortyme 0004, 0006	Harvard 0008, 0104	Mintek 0091	RCA 0000, 0003, 0004, 0005, 0006, 0013, 0024, 0035
Concerto 0004, 0006	Havermy 0014	Mitsubishi 0004, 0005, 0006, 0014, 0045	Realistic 0100, 0104
Contec 0104	Hewlett Packard 0053	Monivision 0097	Runco 0011, 0099, 0100
Contec/Cony 0007, 0008	Hisense 0069	Montgomery Ward 0001	Sampo 0004, 0006, 0100, 0107
Craig 0008, 0104			
Crosley 0081, 0101			
Crown 0008, 0104			
CTX 0063			

Samsung 0004, 0005, 0006, 0007, 0022, 0032, 0076, 0077, 0083, 0100, 0110	Sony 0002, 0018, 0029, 0030, 0031, 0034	Syntax 0054	Vidtech 0004, 0005, 0006
Sansui 0025	Soundesign 0004, 0006, 0008, 0009, 0104	Syntax-Brilliant 0054	Viewsonic 0058, 0107
Sanyo 0004, 0050	Squareview 0103	Tandy 0014	Viking 0012
Sceptre 0072	SSS 0004, 0008, 0104	Tatung 0003, 0108	Viore 0089
Scotch 0006	Starlite 0008, 0104	Technics 0010, 0105	Vizio 0004, 0070, 0071, 0108
Scott 0004, 0006, 0007, 0008, 0009, 0090, 0104	Superscan 0014	Techwood 0004, 0006, 0010	Wards 0000, 0001, 0004, 0005, 0006, 0009, 0100, 0101
Sears 0000, 0004, 0006, 0009, 0101, 0102, 0103	Supre-Macy 0012	Teknika 0001, 0004, 0005, 0006, 0007, 0008, 0009, 0101, 0104	Waycon 0102
Sharp 0004, 0006, 0007, 0014, 0033	Supreme 0002	TMK 0004, 0006	Westinghouse 0047, 0051
Sheng Chia 0014	SVA 0088	TNCi 0099	White Westinghouse 0023
Shogun 0004	Sylvania 0004, 0006, 0049, 0079, 0080, 0100, 0101, 0103	Toshiba 0026, 0028, 0036, 0038, 0040, 0043, 0102	Yamaha 0004, 0005, 0006, 0100
Signature 0001	Symphonic 0008, 0041, 0103, 0104	Vector Research 0100	Zenith 0001, 0004, 0011, 0015, 0099

DVD

If operations are not possible using the preset codes below, you may be able to conduct operations with the preset codes for the **BD, DVR (BDR, HDR)**.

Pioneer 2014, 2158	Denon 2026, 2068	KLH 2070, 2080	Rowa 2071
Accurian 2092	Desay 2055	Koss 2024, 2069, 2075	Samsung 2009, 2011, 2015, 2031, 2044, 2068
Advent 2072	DiamondVision 2042	Landel 2093	Sansui 2066
Aiwa 2012	Disney 2022	Lasonic 2085	Sanyo 2066, 2083
Akai 2066	Durabrand 2090	Lennox 2074, 2090	Sharp 2035
Alco 2070	Emerson 2067, 2082, 2091	LG 2019, 2051, 2061, 2082, 2087	Sherwood 2063
Allegro 2087	Enterprise 2082	Liquid Video 2075	Shinonic 2086
Amphion MediaWorks 2037	ESA 2053, 2091	Liteon 2025, 2092	Sonic Blue 2087
AMW 2037	Fisher 2083	Magnavox 2067, 2076, 2091	Sony 2003, 2004, 2010, 2012, 2027, 2046, 2047, 2048
Apex 2002, 2018, 2079, 2080	Funai 2091	Memorex 2066	Sungale 2054
Apple 2058	GE 2016, 2077, 2080	Microsoft 2077	Superscan 2067
Arrgo 2088	GFM 2043	Mintek 2038, 2080, 2086	Sylvania 2023, 2067, 2091
Aspire 2073	Go Video 2087	Mitsubishi 2020	Symphonic 2023
Astar 2052	Gradiente 2068	Nesa 2080	Teac 2070
Audiovox 2070	Greenhill 2080	Next Base 2093	Technics 2068
Axion 2040	Haier 2094	Nexxtech 2056	Theta Digital 2078
Bang & Olufsen 2081	Harman/Kardon 2030, 2084	Onkyo 2076	Toshiba 2001, 2006, 2049, 2066, 2076
Blaupunkt 2080	Hitachi 2011	Oppo 2041, 2057	Trutech 2000
Blue Parade 2078	Hiteker 2079	Oritron 2069, 2075	Urban Concepts 2076
Boston 2059	iLive 2062	Panasonic 2005, 2007, 2017, 2032, 2033, 2050, 2068, 2076	US Logic 2086
Broksonic 2066	Ilo 2038	Philips 2045, 2076	Venturer 2070
California Audio Labs 2068	Initial 2038, 2080	Proceed 2079	Xbox 2077
CambridgeSoundWorks 2065	Insignia 2036, 2064, 2091	Proscan 2077	Yamaha 2005, 2068
CineVision 2087	Integra 2078	Qwestar 2069	Zenith 2019, 2076, 2082, 2087
Coby 2029	iSymphony 2060	RCA 2008, 2016, 2070, 2077, 2078, 2080	
Curtis Mathes 2089	JBL 2084	Regent 2074	
CyberHome 2000, 2088	JVC 2013	Rio 2087	
Cytron 2039	Kawasaki 2070		
Daewoo 2021, 2087	Kenwood 2028, 2068		

BD

If operations are not possible using the preset codes below, you may be able to conduct operations with the preset codes for the **DVD, DVR (BDR, HDR)**.

Pioneer 2159, 2160	Kenwood 2044	Panasonic 2114, 2115, 2116	Toshiba 2125, 2099
Denon 2147, 2148, 2149	LG 2123, 2124	Philips 2117	Yamaha 2134, 2135, 2136
Hitachi 2144, 2145, 2146	Marantz 2139, 2140	Samsung 2119	
JVC 2127, 2128, 2130, 2131, 2132, 2133	Mitsubishi 2137, 2138	Sharp 2141, 2142, 2143	
	Onkyo 2126	Sony 2120, 2121, 2122, 2129	

DVR (BDR, HDR)

If operations are not possible using the preset codes below, you may be able to conduct operations with the preset codes for the **DVD, BD**.

Pioneer 2103, 2150, 2151, 2152, 2153, 2154, 2155, 2156, 2157	Sharp 2104, 2112
Panasonic 2100, 2106	Sony 2105, 2108, 2109, 2110, 2113
	Toshiba 2111

VCR

- Pioneer** 1035
ABS 1017
Adventura 1005
Aiwa 1005
Alienware 1017
American High 1004
Asha 1002
Audio Dynamics 1000
Audiovox 1003
Bang & Olufsen 1032
Beaumarck 1002
Bell & Howell 1001
Calix 1003
Candle 1002, 1003
Canon 1004
Citizen 1002, 1003
Colortyme 1000
Craig 1002, 1003
Curtis Mathes 1000, 1002, 1004
Cybernex 1002
CyberPower 1017
Daewoo 1005
DBX 1000
Dell 1017
DIRECTV 1016, 1020, 1022, 1023, 1024, 1027, 1030, 1031
Dish Network 1029
Dishpro 1029
Durabrand 1018
Dynatech 1005
Echostar 1029
Electrohome 1003
Electrohome 1003
Emerson 1003, 1004, 1005
Expressvu 1029
Fisher 1001
Fuji 1004
Funai 1005
Garrard 1005
Gateway 1017
GE 1002, 1004
GOI 1029
Goldstar 1000, 1003
Gradiente 1005
Harley Davidson 1005
Harman/Kardon 1000
Headquarter 1001
Hewlett Packard 1017
HNS 1016
Howard Computers 1017
HP 1017
HTS 1029
Hughes Network Systems 1016, 1020, 1022, 1023, 1024
Humax 1016, 1020
Hush 1017
iBUYPOWER 1017
Instant Replay 1004
JC Penney 1000, 1001, 1002, 1003, 1004
JCL 1004
JVC 1000, 1001, 1020, 1029
Kenwood 1000, 1001
Kodak 1003, 1004
LG 1003
Linksys 1017
Lloyd's 1005
LXI 1003
Magnavox 1004, 1018
Magnin 1003
Marantz 1000, 1001, 1004
Marta 1003
Matsushita 1004
Media Center PC 1017
MEI 1004
Memorex 1001, 1002, 1003, 1004, 1005, 1018, 1019
MGN Technology 1002
Microsoft 1017
Mind 1017
Mitsubishi 1010
Motorola 1004
MTC 1002
Multitech 1002, 1005
NEC 1000, 1001
Nikko 1003
Niveus Media 1017
Noblex 1002
Northgate 1017
Olympus 1004
Optimus 1003
Orion 1014, 1019
Panasonic 1004, 1008
Philco 1004
Philips 1004, 1011, 1016, 1020, 1022, 1023, 1024, 1025
Philips Magnavox 1011
Pilot 1003
Proscan 1030
Pulsar 1018
Quarter 1001
Quartz 1001
Quasar 1004
Radio Shack 1003
Radio Shack/Realistic 1001, 1002, 1003, 1004, 1005
Radix 1003
Randex 1003
RCA 1002, 1004, 1007, 1016, 1020, 1022, 1030, 1031
Realistic 1001, 1002, 1003, 1004, 1005
ReplayTV 1026
Ricavision 1017
Runco 1018
Samsung 1002, 1016, 1022, 1024
Sanky 1018
Sansui 1014, 1019
Sanyo 1001, 1002
Sears 1001, 1003, 1004
Sharp 1012
Shogun 1002
Singer 1004
Sonic Blue 1026
Sony 1006, 1009, 1017, 1021
Stack 1017
STS 1004
Sylvania 1004, 1005
Symphonic 1005
Systemax 1017
Tagar Systems 1017
Tandy 1001
Tashiko 1003
Teac 1005
Technics 1004
Teknika 1003, 1004, 1005
Tivo 1016, 1020, 1021, 1022, 1025
TMK 1002
Toshiba 1015, 1017, 1028
Totevision 1002, 1003
Touch 1017
UltimateTV 1031
Unitech 1002
Vector Research 1000
Video Concepts 1000
Videosonic 1002
Viewsonic 1017
Voodoo 1017
Wards 1002, 1003, 1004, 1005
XR-1000 1004, 1005
Yamaha 1000, 1001
Zenith 1013, 1018
ZT Group 1017

Satellite Set Top Box

- Pioneer** 0126, 6097, 6098, 6145
ADB 6035, 6001
Akai 6102
Alba 6005, 6013, 6011
Allsat 6102
Alltech 6011
Amstrad 6033, 6030, 6044
Anttron 6013
Asat 6102
Austar 6000, 6045
BELL 6160
Bell ExpressVu 6002, 6003
British Sky Broadcasting 6030
Canal 6105
Chaparral 6034
CNS 6001
Coolsat 6021
Crossdigital 6043
Digenius 6104
Digiwave 6053
DirecTV 6070, 6110, 6111, 6062, 6063, 6113, 6008, 6038, 6054, 6069, 6060, 6059, 6043, 6018, 6114, 6115, 6116, 6093
Dish Network System 6002, 6089, 6003, 6004
Dishpro 6002, 6089, 6004
DX Antenna 6140
E Aichi 6141
Echostar 6002, 6089, 6036, 6005, 6003, 6004, 6146
Expressvu 6002, 6004
Fujitsu 6133, 6134, 6135
Fortec Star 6123, 6023
Fresat 6014
Funai 6070
GE 6111
General Instrument 6032
GOI 6002, 6004
Grundig 6007, 6030
Hirschmann 6033
Hisense 6020
Hitachi 6038, 6049, 6132
Houston 6002
HTS 6002, 6004
Hughes Network Systems 6113, 6038, 6054, 6114, 6115, 6116
Hyundai 6016
iLo 6020
Innova 6059
Jerrold 6032, 6128, 6149, 6150, 6151, 6152, 6153, 6154, 6155, 6156, 6157
JVC 6002, 6003, 6004
Kathrein 6096
Lava 6053
LG 6047, 6018
Marantz 6102
McIntosh 6032
Mitsubishi 6038
Motorola 6032, 6042
NEC 6050, 6131
Netsat 6059
Next Level 6032
nfusion 6015
Nokia 6025, 6026, 6118, 6119, 6121
Pace 6035, 6005, 6030, 6031
Panarex 6016
Panasonic 6008, 6009, 6030, 6136, 6137, 6138
Pansat 6016, 6022
Philips 6002, 6113, 6038, 6054, 6060, 6059, 6102, 6103, 6030, 6114
Primestar 6032, 6147
Proscan 6110, 6111
Proton 6020
RadioShack 6002, 6111, 6032
Radix 6036
RCA 6002, 6110, 6111, 6113, 6109, 6061, 6114, 6142, 6144, 6148
SA 6124, 6126, 6158, 6159
Saba 6014
Sagem 6041, 6120
Samsung 6070, 6113, 6091, 6043, 6017, 6114, 6093
Sanyo 6046
Sat Cruiser 6015
Schwaiger 6066
SEI 6139
Siemens 6007, 6036
SKY 6042, 6059, 6030, 6031
SM Electronic 6011
Smart 6051
Sonicview 6055, 6107
Sony 6062, 6063, 6030, 6143
Star Choice 6032
Star Trak 6032
TechniSat 6033
Thomson 6110, 6111, 6014
Tivo 6113, 6114, 6115, 6116
Toshiba 6038, 6054, 6039, 6130
TPS 6041
Triasat 6033
Ultrasat 6021
US Digital 6020
USDTV 6020
ViewSat 6048
Voom 6032
Zehnder 6101
Zenith 6042, 6069, 6037, 6125, 6127, 6129

Satellite Set Top Box (SAT/PVR Combination)

Pioneer 0126, 0128
Bell ExpressVu 6002, 6003
DirectTV 6070, 6110, 6062, 6113, 6060, 6059, 6114, 6115, 6116
Dish Network System 6002, 6089

Dishpro 6002, 6089
Echostar 6002, 6089, 6003
Expressvu 6002
Hughes Network Systems 6113, 6114, 6115, 6116

JVC 6003
Motorola 6032
Philips 6113, 6114
Proscan 6110
Samsung 6114

Sonicview 6055, 6107
Sony 6062
Star Choice 6032
Tivo 6113, 6114, 6115, 6116

Cable Set Top Box

Pioneer 6028, 6029, 6095, 6099
ABC 6122
Accuphase 6122
Amino 6077, 6078
Auna 6082
BCC 6072
Bell & Howell 6122
Bright House 6074, 6029
Cable One 6074, 6029
Cablevision 6074, 6029
Charter 6074, 6029, 6058
Cisco 6029, 6028, 6083
Comcast 6074, 6029, 1982
Cox 6074, 6029
Digeo 6029, 6058

Director 6073
Emerson 6122
Fosgate 6072
General Instrument 6073, 6072, 6122
Homecast 6024
i3 Micro 6077
Insight 6074, 6073, 6029
Jebsee 6122
Jerrold 6073, 6072, 6122
Knology 6029
Macab 6040
Mediacom 6074, 6029
Memorex 6112

Motorola 6074, 6073, 6072, 6029, 6122, 6094
MTS 6094
Myrio 6077, 6078
Noos 6040
Pace 6074, 6029, 6028, 6106, 6083
Panasonic 6112, 6083
Paragon 6112
Penney 6112
Philips 6012
Pulsar 6112
Quasar 6112
Regal 6072
Rogers 6029
Runco 6112

Samsung 6095
Scientific Atlanta 6029, 6028, 6027, 6112
Sejin 6077
Shaw 6074
Starcom 6122
Stargate 6122
Suddenlink 6074, 6029
Supercable 6072
Time Warner 6074, 6029, 6058
Tivo 6076
Toshiba 6112
United Cable 6072, 6122
US Electronics 6072
Videoway 6112
Zenith 6112

Cable Set Top Box (Cable/PVR Combination)

Pioneer 0127, 6029
Amino 6078
Bright House 6074, 6029
Cable One 6074, 6029
Cablevision 6074, 6029
Charter 6074, 6029, 6058

Cisco 6029, 6083
Comcast 6074, 6029, 6083, 6076
Cox 6074, 6029
Digeo 6081, 6058
Homecast 6024
Insight 6074, 6029
Knology 6029

Mediacom 6074, 6029
Motorola 6074, 6081
Myrio 6078
Pace 6029
Panasonic 6083
Rogers 6029
Scientific Atlanta 6029

Shaw 6074
Suddenlink 6074, 6029
Supercable 6072
Time Warner 6074, 6029, 6058
Tivo 6076

CD

Pioneer 5065, 5066
AKAI 5043
Asuka 5045
Denon 5019
Fisher 5048
Goldstar 5040

Hitachi 5042
Kenwood 5020, 5021, 5031
Luxman 5049
Marantz 5033
Onkyo 5017, 5018, 5030, 5050
Panasonic 5036

Philips 5022, 5032, 5044
RCA 5013, 5029
Roadstar 5052
Sharp 5051
Sony 5012, 5023, 5026, 5027, 5028, 5039
TEAC 5015, 5016, 5034, 5035, 5037

Technics 5041
Victor 5014
Yamaha 5024, 5025, 5038, 5046, 5047

CD-R

Pioneer 5067

Philips 5054

Yamaha 5055

Laser Disc Player

Pioneer 5062, 5063

Cassette Deck

Pioneer 5058, 5059, 5070

Digital Tape

Pioneer 5069

MD

Pioneer 5068

Specifications

Amplifier Section

Continuous average power output of 140 watts* per channel, min., at 8 ohms, from 20 Hz to 20 000 Hz with no more than 0.08 % total harmonic distortion.**

Multi channel simultaneous power output (1 kHz, 1 %, 8 Ω)	
7 ch total	770 W (SC-37)/700 W (SC-35)
Continuous Power Output (20 Hz to 20 kHz, 8 Ω, 0.08 %)	
Front	140 W + 140 W
Center	140 W
Surround	140 W + 140 W
Surround back (Front height/wide)	140 W + 140 W
Continuous Power Output (1 kHz, 6 Ω, 1.0 %)	
Front	180 W + 180 W
Center	180 W
Surround	180 W + 180 W
Surround back (Front height/wide)	180 W + 180 W
Total harmonic distortion	0.05 %
	(20 Hz to 20 kHz, 130 W, 8 Ω)

* Measured pursuant to the Federal Trade Commission's Trade Regulation rule on Power Output Claims for Amplifiers
 ** Measured by Audio Spectrum Analyzer

Audio Section

Input (Sensitivity/Impedance)	
PHONO MM	.5 mV/47 kΩ
LINE	.400 mV/47 kΩ
Output (Level/Impedance)	
REC	400 mV/2.2 kΩ
Signal-to-Noise Ratio (IHF, short circuited, A network)	
LINE	103 dB
Frequency Response	.5 Hz to 100 000 Hz ±3 dB
	(Pure Direct Mode)

Tuner Section

Frequency Range (FM)	87.5 MHz to 108 MHz
Antenna Input (FM)	75 Ω unbalanced
Frequency Range (AM)	531 kHz to 1602 kHz
Antenna (AM)	Loop antenna (balanced)

Video Section

Signal level	
Composite Video	1 Vp-p (75 Ω)
Component Video	Y: 1.0 Vp-p (75 Ω), PB, PR: 0.7 Vp-p (75 Ω)
Corresponding maximum resolution	
Component Video	1080p (1125p)
	(Video convert off)

Digital In/Out Section

HDMI terminal	19-pin (Not DVI)
HDMI output type	5 V, 100 mA
USB terminal	USB2.0 Full Speed (Type A)
iPod terminal	USB, and Video (Composite)
SIRIUS antenna cable	8-pin mini DIN cable
ADAPTER PORT terminal	5 V, 100 mA

Integrated Control Section

Control (SR) terminal	∅ 3.5 Mini-jack (MONO)
Control (IR) terminal	∅ 3.5 Mini-jack (MONO)
IR signal	High Active (High Level: 2.0 V)
12 V Trigger terminal	∅ 3.5 Mini-jack (MONO)
12 V Trigger output type	12 V, Total 150 mA
RS-232C cable type	9-pin, cross type, female-female
EXTENSION terminal (SC-35 only)	5 V, 150 mA
CU-RF100 terminal (SC-37 only)	5 V, 150 mA

Network Section

LAN terminal	10 BASE-T/100 BASE-TX
--------------	-----------------------

Remote control unit (SC-37 only)

Power	DC 3 V
Estimated line-of-sight transmission distance*	About 10 m
Radio frequency band	2.4 GHz
Modulation system	Direct Sequence Spread Spectrum (DSSS)
Dimensions	51 mm (W) x 255 mm (H) x 34 mm (D)
	(2 1/16 in. (W) x 10 1/16 in. (H) x 1 3/8 in. (D))
Weight	190 g (0.4 lb)

RF adapter (SC-37 only)

Power	DC 5 V
Estimated line-of-sight transmission distance*	About 10 m
Radio frequency band	2.4 GHz
Modulation system	Direct Sequence Spread Spectrum (DSSS)
Dimensions	49 mm (W) x 21 mm (H) x 64.5 mm (D)
	(2 in. (W) x 7/8 in. (H) x 2 9/16 in. (D))
Weight	90 g (0.2 lb)

* The line-of-sight transmission distance is an estimate. Actual transmission distances supported may differ depending on surrounding conditions.

Miscellaneous

Power requirements	.AC 120 V, 60 Hz
Power consumption	.330 W
In standby	.0.2 W (HDMI Setup – Control : OFF)
	.0.3 W (HDMI Setup – Control : ON)
Dimensions	420 mm (W) x 200 mm (H) x 460 mm (D)
	(16 9/16 in. (W) x 7 7/8 in. (H) x 18 1/8 in. (D))
Weight (without package)	18.5 kg (40.8 lb)

Number of Furnished Parts

Incase of SC-37:

MCACC Setup microphone (APM7009)	1
Omni-directional remote control (CU-RF100) (AXD7580)	1
RF adapter (AXX7272)	1
IR blaster cable (ADF7007)	2
AA/LR6 dry cell batteries	4
iPod cable	1
AM loop antenna	1
FM wire antenna	1
Power cord	1
Warranty card	1
These operating instructions	

Incase of SC-35:

MCACC Setup microphone (APM7009)	1
Remote control unit (AXD7591)	1
AAA size IEC R03 dry cell batteries	2
iPod cable	1
AM loop antenna	1
FM wire antenna	1
Power cord	1
Warranty card	1
These operating instructions	



Note

- Specifications and the design are subject to possible modifications without notice, due to improvements.

Cleaning the unit

- Use a polishing cloth or dry cloth to wipe off dust and dirt.
- When the surface is dirty, wipe with a soft cloth dipped in some neutral cleanser diluted five or six times with water, and wrung out well, and then wipe again with a dry cloth. Do not use furniture wax or cleansers.
- Never use thinners, benzene, insecticide sprays or other chemicals on or near this unit, since these will corrode the surface.

This product includes FontAvenue® fonts licenced by NEC corporation. FontAvenue is a registered trademark of NEC Corporation



Dear Customer:

Selecting fine audio equipment such as the unit you've just purchased is only the start of your musical enjoyment. Now it's time to consider how you can maximize the fun and excitement your equipment offers. This manufacturer and the Electronic Industries Association's Consumer Electronics Group want you to get the most out of your equipment by playing it at a safe level. One that lets the sound come through loud and clear without annoying blaring or distortion-and, most importantly, without affecting your sensitive hearing.

Sound can be deceiving. Over time your hearing "comfort level" adapts to higher volumes of sound. So what sounds "normal" can actually be loud and harmful to your hearing. Guard against this by setting your equipment at a safe level BEFORE your hearing adapts.

To establish a safe level:

- Start your volume control at a low setting.
- Slowly increase the sound until you can hear it comfortably and clearly, and without distortion.

Once you have established a comfortable sound level:

- Set the dial and leave it there.

Taking a minute to do this now will help to prevent hearing damage or loss in the future. After all, we want you listening for a lifetime.

We Want You Listening For A Lifetime

Used wisely, your new sound equipment will provide a lifetime of fun and enjoyment. Since hearing damage from loud noise is often undetectable until it is too late, this manufacturer and the Electronic Industries Association's Consumer Electronics Group recommend you avoid prolonged exposure to excessive noise. This list of sound levels is included for your protection.

Decibel Level Example

30	Quiet library, soft whispers
40	Living room, refrigerator, bedroom away from traffic
50	Light traffic, normal conversation, quiet office
60	Air conditioner at 20 feet, sewing machine
70	Vacuum cleaner, hair dryer, noisy restaurant
80	Average city traffic, garbage disposals, alarm clock at two feet.

THE FOLLOWING NOISES CAN BE DANGEROUS UNDER CONSTANT EXPOSURE

90	Subway, motorcycle, truck traffic, lawn mower
100	Garbage truck, chain saw, pneumatic drill
120	Rock band concert in front of speakers, thunderclap
140	Gunshot blast, jet plane
180	Rocket launching pad

Information courtesy of the Deafness Research Foundation.



S001_A1_En

To register your product, find the nearest authorized service location, to purchase replacement parts, operating instructions, or accessories, please go to one of following URLs :

Pour enregistrer votre produit, trouver le service après-vente agréé le plus proche et pour acheter des pièces de rechange, des modes d'emploi ou des accessoires, reportez-vous aux URL suivantes :

In the USA/Aux Etats-Unis

<http://www.pioneerelectronics.com>

In Canada/Aux Canada

<http://www.pioneerelectronics.ca>

S018_B1_EnFr

Register Your Product on

<http://www.pioneerelectronics.com> (US)

<http://www.pioneerelectronics.ca> (Canada)

PIONEER CORPORATION

1-1, Shin-ogura, Saiwai-ku, Kawasaki-shi, Kanagawa 212-0031, Japan

PIONEER ELECTRONICS (USA) INC.

P.O. BOX 1540, Long Beach, California 90801-1540, U.S.A. TEL: (800) 421-1404

PIONEER ELECTRONICS OF CANADA, INC.

300 Allstate Parkway, Markham, Ontario L3R 0P2, Canada TEL: 1-877-283-5901, 905-479-4411

PIONEER EUROPE NV

Haven 1087, Keetberglaan 1, B-9120 Melsele, Belgium TEL: 03/570.05.11

PIONEER ELECTRONICS ASIACENTRE PTE. LTD.

253 Alexandra Road, #04-01, Singapore 159936 TEL: 65-6472-7555

PIONEER ELECTRONICS AUSTRALIA PTY. LTD.

178-184 Boundary Road, Braeside, Victoria 3195, Australia, TEL: (03) 9586-6300

PIONEER ELECTRONICS DE MEXICO S.A. DE C.V.

Blvd.Manuel Avila Camacho 138 10 piso Col.Lomas de Chapultepec, Mexico, D.F. 11000 TEL: 55-9178-4270

K002_B1_En

Published by Pioneer Corporation.
Copyright © 2010 Pioneer Corporation.
All rights reserved.