

Operation Manual

6.5 inch Wide AV System Display/DVD Player

AVX-P8DVD

Thank you for buying this Pioneer product.

Please read through these operating instructions so you will know how to operate your model properly. *After you have finished reading the instructions, keep this manual in a safe place for future reference.*



Be sure to read this

- Playable discs 8
- DVD video disc region numbers 8
- When an operation is prohibited 12

01 Precautions

IMPORTANT SAFEGUARDS 6

To ensure safe driving 6

To avoid battery exhaustion 7

02 Before You Start

Information to User 8

About this unit 8

About this manual 9

After-sales service for Pioneer products 9

Product registration 9

Precautions 10

Features 10

About WMA 11

To protect the LCD screen 11

For viewing LCD comfortably 12

What the marks on DVDs indicate 12

Switching the operation mode 12

Resetting the microprocessor 12

Use and care of the remote control 13

03 What's What

Display unit 14

Remote control 16

04 Basic Operations

Turning the unit on and selecting a source 19

Loading a disc 20

Turning the unit off 20

Using the rear display 20

Displaying the navigation image 21

Touch panel key basic operation 22

Opening and closing the LCD panel 23

Changing the wide screen mode 24

Adjusting the picture adjustment 24

Protecting your unit from theft 26

05 Playing DVD video discs

Watching a DVD video 27

Operating the DVD menu 28

Skipping back or forward to another title 28

Stopping playback 28

Introduction of advanced DVD video operation 29

Repeating play 29

Pausing DVD video playback 29

Frame-by-frame playback 29

Slow motion playback 30

Searching for a desired scene, starting playback from a specified time 30

Changing audio language during playback (Multi-audio) 31

Changing the subtitle language during playback (Multi-subtitle) 31

Changing the viewing angle during playback (Multi-angle) 32

Resume playback (Bookmark) 32

Selecting audio output 32

06 Playing Video CDs

Watching a Video CD 33

PBC playback 34

Operating the menu 34

Stopping playback 34

Introduction of advanced Video CD operation 35

Repeating play 35

Pausing Video CD playback 35

Frame-by-frame playback 35

Slow motion playback 36

- Searching for a desired scene, starting playback from a specified time **36**
- Selecting audio output **37**
- 07 Playing CDs**
 - Listening to a CD **38**
 - Stopping playback **38**
 - Introduction of advanced CD operation **39**
 - Repeating play **39**
 - Playing tracks in a random order **40**
 - Scanning tracks of a CD **40**
 - Pausing CD playback **40**
 - Searching for a desired track **40**
 - Entering disc titles **41**
 - Using CD TEXT functions **41**
- 08 Playing MP3/WMA**
 - Listening to MP3/WMA **43**
 - Stopping playback **44**
 - Introduction of advanced built-in DVD player (MP3/WMA) operation **45**
 - Repeating play **45**
 - Playing tracks in a random order **45**
 - Scanning folders and tracks **46**
 - Pausing MP3/WMA playback **46**
 - Searching for a desired track in the current folder **46**
 - Displaying text information on MP3/WMA disc **46**
 - Scrolling text information in the display **47**
 - Selecting tracks from the file name list **47**
- 09 Multi-CD Player**
 - Listening to a CD **48**
 - 50-disc multi-CD player **49**
 - Introduction of advanced multi-CD player operation **49**
 - Repeating play **50**
 - Playing tracks in a random order **50**
 - Scanning CDs and tracks **50**
 - Pausing CD playback **50**
 - Using ITS playlists **51**
 - Using disc title functions **52**
 - Using CD TEXT functions **53**
 - Using compression and bass emphasis **54**
- 10 TV tuner**
 - Watching the television **55**
 - Storing the strongest broadcast stations sequentially **56**
 - Storing and recalling broadcast stations **56**
- 11 Setting up the DVD player**
 - Introduction of DVD setup adjustments **57**
 - Setting the subtitle language **57**
 - Setting the audio language **58**
 - Setting the menu language **58**
 - Setting assist subtitles on or off **58**
 - Setting angle icon display **59**
 - Setting the aspect ratio **59**
 - Setting the parental lock **59**
 - Setting for digital output **60**
 - Setting digital and analog audio output **61**
 - Automatic playback of DVDs **61**
 - Setting remote control code type **62**
- 12 Initial Settings**
 - Adjusting initial settings **63**
 - Switching the warning tone **63**
 - Switching the auxiliary setting **63**
 - Switching the automatic disc playback **63**
 - Switching the wired remote control setting **64**
 - Selecting remote control code type **64**
- 13 Other Functions**
 - Introduction of setup adjustments **65**
 - Setting the video input 1 **65**

Setting the video input 2	65
Selecting the video of rear display	66
Setting the automatic open function	66
Setting the clock	67
Using the AUX source	67
Switching the background display	68
Using the PGM button	69
When combined with a Pioneer head unit	69
Introduction of DVD operation	70

● Additional Information

Troubleshooting	71
Error messages	73
DVD player and care	74
DVD discs	74
CD-R/CD-RW discs	74
MP3 and WMA files	75
About folders and MP3/WMA files	76
Using the display correctly	77
Language code chart for DVD	79
Terms	80
Specifications	83

● Index 84



Dear Customer:

Selecting fine audio equipment such as the unit you've just purchased is only the start of your musical enjoyment. Now it's time to consider how you can maximize the fun and excitement your equipment offers. This manufacturer and the Electronic Industries Association's Consumer Electronics Group want you to get the most out of your equipment by playing it at a safe level. One that lets the sound come through loud and clear without annoying blaring or distortion—and, most importantly, without affecting your sensitive hearing.

Sound can be deceiving. Over time your hearing "comfort level" adapts to higher volumes of sound. So what sounds "normal" can actually be loud and harmful to your hearing. Guard against this by setting your equipment at a safe level BEFORE your hearing adapts.

To establish a safe level:

- Start your volume control at a low setting.
- Slowly increase the sound until you can hear it comfortably and clearly, and without distortion.

Once you have established a comfortable sound level:

- Set the dial and leave it there.

Taking a minute to do this now will help to prevent hearing damage or loss in the future. After all, we want you listening for a lifetime.

We Want You Listening For A Lifetime

Used wisely, your new sound equipment will provide a lifetime of fun and enjoyment. Since hearing damage from loud noise is often undetectable until it is too late, this manufacturer and the Electronic Industries Association's Consumer Electronics Group recommend you avoid prolonged exposure to excessive noise. This list of sound levels is included for your protection.

Decibel

<u>Level</u>	<u>Example</u>
30	Quiet library, soft whispers
40	Living room, refrigerator, bedroom away from traffic
50	Light traffic, normal conversation, quiet office
60	Air conditioner at 20 feet, sewing machine
70	Vacuum cleaner, hair dryer, noisy restaurant
80	Average city traffic, garbage disposals, alarm clock at two feet

THE FOLLOWING NOISES CAN BE DANGEROUS UNDER CONSTANT EXPOSURE

90	Subway, motorcycle, truck traffic, lawn mower
100	Garbage truck, chain saw, pneumatic drill
120	Rock band concert in front of speakers, thunderclap
140	Gunshot blast, jet plane
180	Rocket launching pad

Information courtesy of the Deafness Research Foundation.



IMPORTANT SAFEGUARDS

Please read all of these instructions regarding your display and retain them for future reference.

- 1 Read this manual fully and carefully before operating your display.
- 2 Keep this manual handy as a reference for operating procedures and safety information.
- 3 Pay close attention to all warnings in this manual and follow the instructions carefully.
- 4 Do not allow other persons to use this system until they have read and understood the operating instructions.
- 5 Do not install the display where it may (i) obstruct the driver's vision, (ii) impair the performance of any of the vehicle's operating systems or safety features, including air bags, hazard lamp buttons or (iii) impair the driver's ability to safely operate the vehicle.
- 6 As with any accessory in your vehicle's interior, the display should not divert your attention from the safe operation of your vehicle. If you experience difficulty in operating the system or reading the display, please park safely before making adjustments.
- 7 Do not attempt to install or service your display by yourself. Installation or servicing of the display by persons without training and experience in electronic equipment and automotive accessories may be dangerous and could expose you to the risk of electric shock or other hazards and can cause damage to the system that is not covered by warranty.
- 8 Please remember to wear your seat belt at all times while operating your vehicle. If you are ever in an accident, your injuries can be considerably more severe if your seat belt is not properly buckled.
- 9 Never use headphones while driving.

To ensure safe driving



WARNING

- **LIGHT GREEN LEAD AT POWER CONNECTOR IS DESIGNED TO DETECT PARKED STATUS AND MUST BE CONNECTED TO THE POWER SUPPLY SIDE OF THE PARKING BRAKE SWITCH. IMPROPER CONNECTION OR USE OF THIS LEAD MAY VIOLATE APPLICABLE LAW AND MAY RESULT IN SERIOUS INJURY OR DAMAGE.**
- To avoid the risk of accident and the potential violation of applicable laws, the front DVD or TV (sold separately) feature should never be used while the vehicle is being driven. Also, rear displays should not be in a location where it is a visible distraction to the driver.
- In some countries or states the viewing of images on a display inside a vehicle even by persons other than the driver may be illegal. Where such regulations apply, they must be obeyed and this unit's DVD features should not be used.

This unit detects whether your vehicle's parking brake is engaged or not, and prevents you from watching a DVD or TV on the front display while driving. When you attempt to watch a DVD or TV, the warning **VIDEO VIEWING IS NOT AVAILABLE WHILE DRIVING** will appear on the front display.

To watch a DVD or TV on the front display, park your vehicle in a safe place and apply the parking brake.

When using a display connected to REAR VIDEO OUTPUT

This unit's **REAR VIDEO OUTPUT** is for connection of a display to enable passengers in the rear seats to watch the DVD or TV.

Precautions

WARNING

NEVER install the rear display in a location that enables the driver to watch the DVD or TV while driving. 

To avoid battery exhaustion

Be sure to run the vehicle engine while using this unit. Using this unit without running the engine can result in battery drainage.

WARNING

Do not use with vehicles that do not feature an ACC position. 

Information to User

Alteration or modifications carried out without appropriate authorization may invalidate the user's right to operate the equipment.



About this unit



Important (Serial number)

The serial number is located on the bottom of this unit. For your own security and convenience, be sure to record this number on the enclosed warranty card.

Playable discs

DVD, Video CD and CD discs that display the logos shown below can be played back on this player.

DVD video



Video CD



CD



Note

It is not possible to play back DVD audio disc. This player can only play back discs bearing the marks shown above.

DVD video disc region numbers

DVD video discs that have incompatible region numbers cannot be played on this player. The region number of the player can be found on the bottom of this unit.

The illustration below shows the regions and corresponding region numbers.



When combined with a Pioneer navigation unit

We recommend that you use the latest version of the navigation map disc that is corresponding to the touch panel operation.

When you use this unit with the Pioneer DVD navigation unit, make sure that you use the map disc CNDV-21 or later. This manual explains the operations with the combined use of them.

If you do not use the map disc CNDV-21 but use an older version with the navigation unit, this unit may have some failures or inconveniences as follows:

- **ENTERTAINMENT** button and **WIDE** button cannot function as **POS** button and **NAVI MENU** button.
- **NAVI** (navigation unit), such as DVD video from the combined Pioneer navigation unit

Before You Start

with DVD video playback, cannot be selected as a source.

- Voice-recognition control system of the combined Pioneer navigation unit cannot function properly. The voice operation for navigation can be used, but the voice operation related to AV equipment cannot be used.
- Route guidance of the combined Pioneer navigation unit cannot function properly when some other source images are displayed. Guidance by voice can be obtained, but on guidance by display (e.g. switching to an enlarged map of an intersection) cannot be obtained.
- **NAVI** (navigation unit wallpaper) cannot be selected as a background display.

About this manual

This unit features a number of sophisticated functions ensuring superior reception and operation. All the functions have been designed for the easiest possible use, but many are not self-explanatory. This operation manual will help you benefit fully from this unit's potential and to maximize your listening enjoyment. We recommend that you familiarize yourself with the functions and their operation by reading through the manual before you begin using this unit. It is especially important that you read and observe precautions noted on the next page and in other sections.

After-sales service for Pioneer products

Please contact the dealer or distributor from where you purchased this unit for after-sales service (including warranty conditions) or any other information. In case the necessary infor-

mation is not available, please contact the companies listed below:

Please do not ship your unit to the companies at the addresses listed below for repair without advance contact.

U.S.A.

Pioneer Electronics (USA) Inc.
CUSTOMER SUPPORT DIVISION
P.O. Box 1760
Long Beach, CA 90801-1760
800-421-1404

CANADA

Pioneer Electronics of Canada, Inc.
CUSTOMER SATISFACTION DEPARTMENT
300 Allstate Parkway
Markham, Ontario L3R 0P2
1-877-283-5901

For warranty information please see the Limited Warranty sheet included with this unit.

Product registration

Visit us at the following site:

 <http://www.pioneerelectronics.com>

- 1 Register your product. We will keep the details of your purchase on file to help you refer to this information in the event of an insurance claim such as loss or theft.
- 2 Receive updates on the latest products and technologies.
- 3 Download owner's manuals, order product catalogues, research new products, and much more.

Precautions

WARNING:

Handling the cord on this product or cords associated with accessories sold with the product will expose you to lead, a chemical known to the State of California and other governmental entities to cause cancer and birth defects or other reproductive harm. ***Wash hands after handling.***

This product contains mercury. Disposal of this material may be regulated due to environmental considerations. For disposal or recycling information, please contact your local authorities or the Electronics Industries Alliance: www.eiae.org.

CAUTION:

USE OF CONTROL OR ADJUSTMENT OR PERFORMANCE OF PROCEDURES OTHER THAN THOSE SPECIFIED HEREIN MAY RESULT IN HAZARDOUS RADIATION EXPOSURE.

CAUTION:

THE USE OF OPTICAL INSTRUMENTS WITH THIS PRODUCT WILL INCREASE EYE HAZARD.

- Keep this manual handy as a reference for operating procedures and precautions.
- Always keep the volume low enough so that you can hear sounds from outside the vehicle.
- Protect this unit from moisture.
- If the battery is disconnected or discharged, the preset memory will be erased and must be reprogrammed. 

Features

Touch panel key operation

It is possible to operate this unit by using touch panel key.

DVD video playback

It is possible to play back DVD video, DVD-R (video mode) and DVD-RW (video mode). Remember that use of this system for commercial or public viewing purposes may constitute an infringement on the author's rights protected by the Copyright Law.

Video CDs featuring PBC compatibility

It is possible to play back Video CDs featuring PBC (playback control).

CD playback

Music CD/CD-R/CD-RW playback is possible.

MP3 file playback

You can play back MP3 files recorded on CD-ROM/CD-R/CD-RW (ISO9660 Level 1/Level 2 standard recordings).

- Supply of this product only conveys a license for private, non-commercial use and does not convey a license nor imply any right to use this product in any commercial (i.e. revenue-generating) real time broadcasting (terrestrial, satellite, cable and/or any other media), broadcasting/streaming via internet, intranets and/or other networks or in other electronic content distribution systems, such as pay-audio or audio-on-demand applications. An independent license for such use is required. For details, please visit <http://www.mp3licensing.com>.

WMA file playback

You can play back WMA files recorded on CD-ROM/CD-R/CD-RW (ISO9660 Level 1/Level 2 standard recordings).

NTSC compatibility

This unit is NTSC system compatible. When connecting other components to this unit, be sure components are compatible with the same video system otherwise images will not be correctly reproduced.

Before You Start

Dolby Digital/DTS compatibility

When using this unit with a Pioneer multi-channel processor, you can enjoy the atmosphere and excitement provided by DVD movie and music software featuring 5.1 channel recordings.

- Manufactured under license from Dolby Laboratories. “Dolby” and the double-D symbol are trademarks of Dolby Laboratories.



- “DTS” is a registered trademark of Digital Theater Systems, Inc.



Multi-aspect

Switching between wide screen, letterbox and panscan display is possible.

Multi-audio

You can switch between multiple audio systems recorded on a DVD as desired.

Multi-subtitle

You can switch between multiple subtitle languages recorded on a DVD as desired.

Multi-angle

You can switch between multiple viewing angles of a scene recorded on a DVD as desired.

Note

This product incorporates copyright protection technology that is protected by method claims of certain U.S. patents and other intellectual property rights owned by Macrovision Corporation and other rights owners. Use of this copyright protection technology must be authorized by Macrovision Corporation, and is intended for home and other limited viewing uses only unless otherwise authorized by Macrovision Corporation. Reverse engineering or disassembly is prohibited. ■

About WMA



The Windows Media™ logo printed on the box indicates that this unit can play back WMA data.

WMA is short for Windows Media Audio and refers to an audio compression technology that is developed by Microsoft Corporation. WMA data can be encoded by using Windows Media Player version 7 or later.

Microsoft, Windows Media, and the Windows logo are trademarks, or registered trademarks of Microsoft Corporation in the United States and/or other countries.

Notes

- With some applications used to encode WMA files, this unit may not operate correctly.
- With some applications used to encode WMA files, album names and other text information may not be correctly displayed. ■

To protect the LCD screen







- Do not allow direct sunlight to fall on the display when this unit is not being used. Extended exposure to direct sunlight can result in LCD screen malfunction due to the resulting high temperatures.
- When using a portable phone, keep the antenna of the portable phone away from the display to prevent disruption of the video by the appearance of spots, colored stripes, etc. ■

For viewing LCD comfortably

Due to its construction, the view angle of the LCD screen is limited. The viewing angle (vertical and horizontal) can be increased, however, by using **BRIGHT** to adjust the black density of the video. When using for the first time, adjust the black density in accordance with the viewing angle (vertical and horizontal) to adjust for clear viewing. **DIMMER** can also be used to adjust the brightness of the LCD screen itself to suit your personal preference.

What the marks on DVDs indicate

The marks below may be found on DVD disc labels and packages. They indicate the type of images and audio recorded on the disc, and the functions you can use.

Mark	Meaning
	Indicates the number of audio systems.
	Indicates the number of subtitle languages.
	Indicates the number of viewing angles.
	Indicates the picture size (aspect ratio: screen width-to-height ratio) type.
 	Indicates the number of the region where playback is possible.

When an operation is prohibited

When you are watching a DVD and attempt to perform an operation, it may not be performed because of the programming on the disc. When this happens, the icon  appears on the screen.

- The icon  may not appear with certain discs.

Switching the operation mode

This unit features two operation modes: the IP-BUS mode (**S**) and the ADD-ON mode (**M**). Switch the mode according to the combined components.

- IP-BUS mode (**S**) – Using with a Pioneer head unit featuring an IP-BUS input or multi-channel processor control unit
 - ADD-ON mode (**M**) – Using with a car stereo featuring RCA audio inputs or FM reception capability
- **Use a thin standard tip screwdriver to switch the operation mode switch on the back of this unit.**

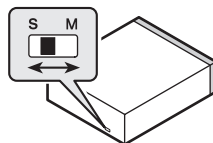

- After switching, reset the microprocessor.

Resetting the microprocessor

Pressing **RESET** lets you reset the microprocessor to its initial settings. The microprocessor must be reset under the following conditions:

- Prior to using this unit for the first time after installation
- If the unit fails to operate properly
- When strange or incorrect messages appear on the display

1 Turn the ignition switch OFF.

Before You Start

- 2 Press **RESET** with a pen tip or other pointed instrument.

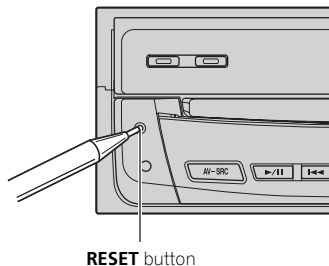

Notes

- When using with a Pioneer navigation unit, if you press **RESET**, be sure **ACC OFF** is selected. If **ACC ON** is selected, correct operation may not be possible even if you press **RESET**.
- After completing connections or when you want to erase all memorized settings or return the unit to its initial (factory) settings, switch your engine **ON** or set the ignition switch to **ACC ON** before pressing **RESET**.

Use and care of the remote control

Installing the battery

Slide the tray out on the back of the remote control and insert the battery with the plus (+) and minus (-) poles pointing in the proper direction.

- When using for the first time, pull out the film protruding from the tray.

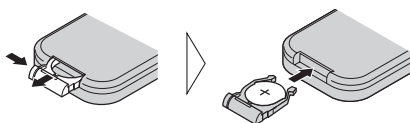

WARNING

Keep the battery out of the reach of children. Should the battery be swallowed, immediately consult a doctor.



CAUTION

- Use only one **CR2025 (3 V)** lithium battery.
- Remove the battery if the remote control is not used for a month or longer.
- Do not recharge, disassemble, heat or dispose of the battery in fire.
- Do not handle the battery with metallic tools.
- Do not store the battery with metallic materials.
- In the event of battery leakage, wipe the remote control completely clean and install a new battery.
- When disposing of used batteries, please comply with governmental regulations or environmental public institutions' rules that apply in your country/area.

Using the remote control

Point the remote control in the direction of the front panel to operate.

- The remote control may not function properly in direct sunlight.



Important

- Do not store the remote control in high temperatures or direct sunlight.
- Do not let the remote control fall onto the floor, where it may become jammed under the brake or accelerator pedal.

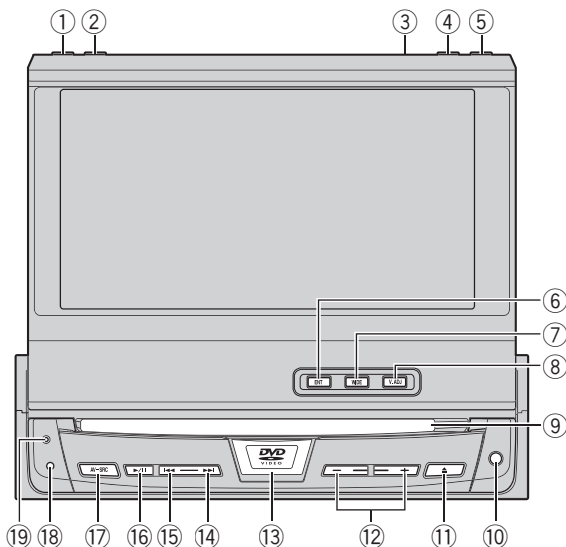

Display unit

① DISPLAY button

Press to select different displays.

② BACK LIGHT button

Press and hold to turn the backlight off.
Press again to turn the backlight on.

③ Ambient light sensor

Senses ambient light. This system automatically adjusts the brightness of the display to compensate for ambient light.

④ FLIP DOWN button

Press to turn the LCD panel horizontal temporarily from upright position.

⑤ OPEN/CLOSE button

Press to open or close the LCD panel.

⑥ ENTERTAINMENT button

Press to switch between the background displays.

⑦ WIDE button

Press to select a desired mode for enlarging a 4:3 picture to a 16:9 one.

⑧ V.ADJ button

Press and hold to display the picture adjustment menu.

⑨ Disc loading slot

Insert a disc to play.

⑩ Signal receptor

Receives signals from a remote control.

⑪ EJECT button

Press to eject a disc from this unit.

⑫ ANGLE (+/-) button

Press to change the LCD panel angle.

What's What

- ⑬ **RELEASE button**
Move downward to remove the front panel from this unit.
- ⑭ **NEXT (▶▶) button**
Press to go to the next track (chapter).
- ⑮ **PREVIOUS (◀◀) button**
Press to return to the previous track (chapter).
- ⑯ **PLAY/PAUSE (▶/||) button**
Press to switch sequentially between playback and pause.
- ⑰ **AV SOURCE button**
This unit is turned on by selecting a source. Press to cycle through all the available sources.
- ⑱ **Rear indicator**
Lights when the DVD player is operated from rear seats.
- ⑲ **RESET button**
Press to return to the factory settings (initial settings). 

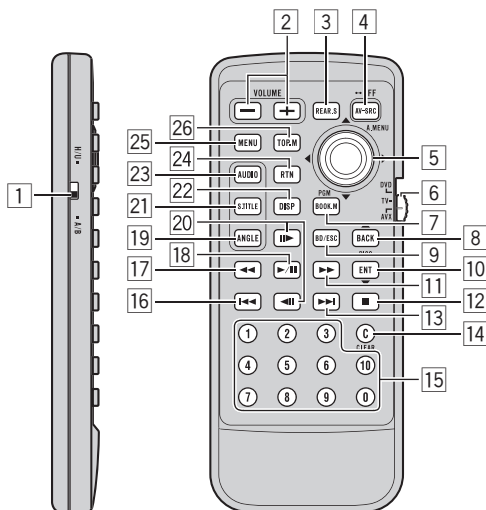

Remote control

1 Remote control selection switch

Switch to change the setting of the remote control. For details, refer to *Setting remote control code type* on page 62 and *Selecting remote control code type* on page 64.

2 VOLUME buttons

Press to increase or decrease the volume on the Pioneer head unit.

3 REAR.S button

Press to watch a DVD/Video CD on a rear display if **DVD** (built-in DVD player) is not selected as the source.

4 AV SOURCE button

This unit is turned on by selecting a source. Press to cycle through all the available sources.

5 Joystick

Move to do fast forward, reverse and track search controls. Also used for controlling functions.

6 Remote control operation mode switch

Switch the operation mode between **AVX**, **DVD** and **TV** modes. Normally, set to **AVX**.

- **AVX** – For common operation of this unit
- **DVD** – Only for DVD player operation
- **TV** – Only for TV tuner operation

For details, refer to *Using the remote control operation mode switch* on the next page.

7 BOOKMARK (BOOK.M) button

AVX mode

Press to operate the preprogrammed functions for each source. (Refer to *Using the PGM button* on page 69.)

DVD mode

Press to turn the bookmark function on or off. For details, refer to *Resume playback (Bookmark)* on page 32.

What's What

- 8 BACK button**
Press to return to the previous display.
- 9 BAND/ESC button**
Press to cancel the control mode of functions.
- 10 ENTERTAINMENT button**
Press to switch between the background displays.
- 11 FORWARD (▶▶) button**
Press to perform fast forward.
- 12 STOP (■) button**
Press to stop playback.
- 13 NEXT (▶▶) button**
Press to go to the next track (chapter).
- 14 CLEAR button**
Press to cancel the input number when **0–10** are used.
- 15 0–10 buttons**
Press to directly select the desired track or disc. Buttons **1–6** can operate disc number search for the multi-CD player.
- 16 PREVIOUS (◀◀) button**
Press to return to the previous track (chapter).
- 17 REVERSE (◀◀) button**
Press to perform fast reverse.
- 18 PLAY/PAUSE (▶/||) button**
Press to switch sequentially between playback and pause.
- 19 ANGLE button**
Press to change the viewing angle during DVD playback.
- 20 STEP (||▶/◀||) button**
Press to move ahead one frame at a time during DVD/VideoCD playback. Press and hold for one second to activate slow playback.
- 21 SUBTITLE (SUB.T) button**
Press to change the subtitle language during DVD playback.
- 22 DISPLAY button**
Press to select different displays.
- 23 AUDIO button**
Press to change the audio language during DVD playback.
- 24 RETURN button**
Press to display the PBC (playback control) menu during PBC playback.
- 25 MENU button**
Press to display the DVD menu during DVD playback.
- 26 TOP MENU (TOP.M) button**
Press to return to the top menu during DVD playback.

Using the remote control operation mode switch

There are three remote control operation modes on the remote control.

AVX mode operation

When operating this unit by remote control, the mode is normally switched to **AVX**.

- Only when using this unit with ADD-ON mode (**M**), the joystick can perform the same operations as the touch panel keys ▲, ▼, ◀ and ▶.

- Only when using this unit with ADD-ON mode (M), **1–6** can perform the same operations as the disc selection keys **01—06**.
 - If you want to select a disc located at 7 to 12 by using buttons **1–6**, press and hold the corresponding numbers, such as **1** for disc 7, until the disc number appears in the display.

DVD mode operation

If you switch the mode to **DVD**, the joystick and **0–10** operations are changed for DVD player.

● When you want to operate the following functions, switch the mode to DVD:

- When operating the DVD menu by using the joystick. (Refer to *Operating the DVD menu* on page 28.)
- When operating the PBC menu by using **0–10**. (Refer to *Watching a Video CD* on page 33.)
- When specifying title by using **0–10**. (Refer to *Specifying title* on page 31.)



Note

With the mode switched to **DVD**, you cannot use these buttons; **BACK**, **ENTERTAINMENT** and **DISPLAY**.

TV mode operation

If you use the rear output on TV tuner, you can watch the TV picture on the rear display independently. To operate the TV on the rear display independently, switch the mode to **TV**. In this case, the joystick operation is changed for TV.

- For details concerning operation, refer to the TV tuner's operation manuals.

● When you want to operate the following functions only on the rear display, switch the mode to TV:

- When performing manual or seek tuning by moving the joystick left or right.
- When recalling preset stations by moving the joystick up or down.



Note

With the mode switched to **TV**, you cannot use any buttons but **AV SOURCE** and **VOLUME**. The joystick is also available in **TV** mode operation.

Basic Operations

Turning the unit on and selecting a source



① Source icon

Shows which source has been selected.

You can select a source you want to listen to. If **DVD D. AUTO** is turned on, load a disc in the unit to switch to **DVD** (refer to *Switching the automatic disc playback* on page 63).

IP-BUS mode (S)

1 Select this DVD player as a source on your head unit.

Refer to the head unit operation manual.

2 Press AV SOURCE to select a video source.

Press **AV SOURCE** repeatedly to switch between the following sources:

DVD (built-in DVD player)—**AV-1** (video input 1)—**AV-2** (video input 2)—**NAVI** (navigation unit)



Note

In the following cases, the sound source will not change:

- When there is no unit corresponding to the selected source connected to this unit.
- When there is no disc in the unit.

- When **AV INPUT1** (video input 1) and/or **AV INPUT2** (video input 2) are not set to **VIDEO** (refer to page 65).

ADD-ON mode (M)

- When using the touch panel keys, touch the source icon and then touch the desired source name.

The source names are displayed and selectable ones are highlighted.

- **DVD** – Built-in DVD player
- **M-CD** – Multi-CD player
- **TV** – Television
- **AV-1** – Video input 1
- **AV-2** – Video input 2
- **EXT-1** – External unit 1
- **EXT-2** – External unit 2
- **AUX** – AUX
- **NAVI** – Navigation unit
- **SOURCE OFF** – Turn the unit off
- When the source icon is not displayed, you can display it by touching the screen.
- To return to the playback display, touch **ESC**.

- When using the button, press **AV SOURCE** to select a source.



Press **AV SOURCE** repeatedly to switch between the following sources:

TV (television)—**AV-1** (video input 1)—**AV-2** (video input 2)—**DVD** (built-in DVD player)—**M-CD** (multi-CD player)—**EXT-1** (external unit 1)—**EXT-2** (external unit 2)—**AUX** (AUX)—**NAVI** (navigation unit)



Notes

- In the following cases, the sound source will not change:
 - When there is no unit corresponding to the selected source connected to this unit.
 - When there is no disc in the unit.
 - When there is no magazine in the multi-CD player.

- When the AUX (auxiliary input) is set to off (refer to page 63).
- When **AV INPUT1** (video input 1) and/or **AV INPUT2** (video input 2) are not set to **VIDEO** (refer to page 65).
- External unit refers to a Pioneer product (such as one available in the future) that, although incompatible as a source, enables control of basic functions by this unit. Two external units can be controlled by this unit. When two external units are connected, the allocation of them to external unit 1 or external unit 2 is automatically set by this unit. 
- If the DVD player does not operate properly, an error message such as **ERROR-02** may be displayed. Refer to *Error messages* on page 73.
- If bookmark function is on, DVD playback resumes from the selected point. For more details, refer to *Resume playback (Bookmark)* on page 32. 

Loading a disc

● Insert a disc into the disc loading slot.

Playback will automatically start.

- When a disc is loaded in this unit, press **AV SOURCE** to select **DVD**.
- If **DVD D. AUTO** is turned off, press **AV SOURCE** to select **DVD** (refer to the previous page).
- If **DVD A. PLAY** is on, **SOME DISCS MAY NOT FULLY OPERATE ON THIS SYSTEM** is displayed. (Refer to *Automatic playback of DVDs* on page 61.)
- To eject a disc, press **EJECT**.



Notes

- The DVD player plays one, standard, 12-cm or 8-cm (single) disc at a time. Do not use an adapter when playing 8-cm discs.
- Do not insert anything other than a disc into the disc loading slot. Discs which can be played back are listed on *Playable discs* on page 8.
- If you cannot insert a disc completely or if after you insert a disc the disc does not play, check that the label side of the disc is up. Press **EJECT** to eject the disc, and check the disc for damage before inserting it again.

Turning the unit off

IP-BUS mode (S)

● Turn this unit off from your head unit.

Refer to the head unit operation manual.

- If you press **AV SOURCE** and hold to turn this unit off, **Power off (POWER OFF)** appears on the head unit's display.

ADD-ON mode (M)

● When using the touch panel keys, touch the source icon and then touch SOURCE OFF.

- When the source icon is not displayed, you can display it by touching the screen.

● When using the button, press AV SOURCE and hold until the unit turns off.

Using the rear display

You can watch a DVD/Video CD on the rear display regardless of whether **DVD** (built-in DVD player) is selected as the source or not.

- To watch a DVD/Video CD on the rear display only, switch the operation mode on the remote control to **DVD**. And you can operate the DVD/Video CD playback on the rear display independently by the remote control. (Refer to page 17.)

Basic Operations

CAUTION

When you have turned the DVD/Video CD playback on by pressing **REAR.S** on the remote control, you cannot turn it off even if you press **AV SOURCE (SOURCE)** and hold. In this case, press **REAR.S** to turn the DVD/Video CD playback off.

- **Press REAR.S to watch a DVD/Video CD on the rear display when DVD (built-in DVD player) is not selected as the source.** DVD/Video CD playback is turned on and the rear indicator lights.
 - To turn the DVD/Video CD playback off, press **REAR.S** again.

Note

When a Pioneer navigation unit is connected to this unit, the navigation image can be displayed on the rear display. (Refer to page 66.) 

Displaying the navigation image

You can display navigation map and navigation menu on this display.

- You can operate these functions only when a Pioneer navigation unit is connected to this unit.

Displaying navigation map

- **Press WIDE to display navigation map.**
 - When the map is scrolled, pressing this button returns to the display of the map of your surroundings.

Displaying navigation menu

- **Press ENTERTAINMENT to display navigation menu when the navigation map is displayed.**
 - You cannot use **ENTERTAINMENT** on the remote control.

Switching to the navigation image

- **Press V.ADJ to switch the display to navigation image.**
 - To return to the video of each source, press **V.ADJ** again. 

Touch panel key basic operation

Activating the touch panel keys

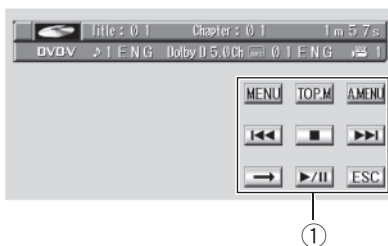

① Touch panel keys

Touch to do various operations.

1 Touch the screen to activate the touch panel keys corresponding to each source.

The touch panel keys appear on the display.

- To go to the next group of touch panel keys, touch **→**.

2 Touch ESC to hide the touch panel keys.

- You can also hide the touch panel keys by pressing **BAND/ESC**.



Note

If you do not use the touch panel keys within 30 seconds, they will be hidden automatically.

Operating the menu

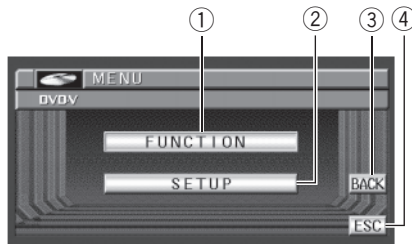

① FUNCTION key

Touch to select functions for each source.

② SETUP key

Touch to select various setup functions.

③ BACK key

Touch to return to the previous display.

④ ESC key

Touch to cancel the control mode of functions.

1 Touch A.MENU to display MENU.

MENU appears on the display.

- When **A.MENU** is not displayed, you can display it by touching the screen.

2 Touch the desired key to display the function names you want to operate.

- To go to the next group of function names, touch **NEXT**.
- To return to the previous group of function names, touch **PREV**.

3 Touch ESC to return to the display of each source.



Note

If you do not operate the function within about 30 seconds, the display is automatically returned to the playback display.

Basic Operations

Operating the menu by using the joystick

You can also perform most of the menu items by using the joystick.

- Switch the remote control operation mode to **AVX** to operate the menu by using the joystick on the remote control. (Refer to page 17.)

1 Click the joystick during display of each source to display MENU.

MENU appears on the display.

2 Move the joystick up or down and then click it to display the function names you want to operate.

- To go to the next group of function names, move the joystick to **NEXT** and click it.
- To return to the previous group of function names, move the joystick to **PREV** and click it.

3 Press BAND/ESC to return to the display of each source.

- You can return to the previous display by pressing **BACK**. 

Opening and closing the LCD panel

The LCD panel will be opened or closed automatically with the turning of the ignition switch on or off. You can turn off the automatic close/open function. (Refer to page 66.)

- Do not close the LCD panel with hands by force. That cause malfunction.
- The automatic close/open function will operate the display as follows.
 - When the ignition switch is turned OFF while the LCD panel is opened, the LCD panel will close after six seconds.
 - When the ignition switch is turned ON again (or turned to ACC), the LCD panel will be opened automatically.

— Removing or attaching the front panel will automatically close or open the LCD panel. (Refer to page 26.)

- When the ignition switch is turned OFF after the LCD panel has been closed, turning the ignition switch ON again (or turning it to ACC) will not open the LCD panel. In this case, press **OPEN/CLOSE** to open the LCD panel.
- When closing the LCD panel, check to make sure that it has closed completely. If the LCD panel has stopped halfway, leaving it like this could result in damage.

● Press OPEN/CLOSE to open the LCD panel.

- To close the LCD panel, press **OPEN/CLOSE** again.

Adjusting the LCD panel angle

Important

- If you can hear the LCD panel knocking against your vehicle's console or dashboard, press **ANGLE (-)** to move the LCD panel a little forward.
- When adjusting the LCD panel angle, be sure to press **ANGLE (+/-)**. Forcibly adjusting the LCD panel by hand may damage it.

● Press ANGLE (+/-) to adjust the LCD panel to an easily viewable angle.

The LCD panel angle continues changing as long as you press **ANGLE (+/-)** and hold.

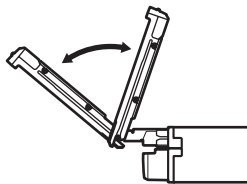

- The adjusted the LCD panel angle will be memorized and automatically returned to the next time the LCD panel is opened.

Turning the LCD panel horizontal

When the LCD panel is upright and it hinders the operation of the air conditioner, the panel can be turned horizontal temporarily.

- **Press FLIP DOWN to turn the LCD panel horizontal.**

- To return to original position, press **FLIP DOWN** again.
- The LCD panel returns to the original position automatically with beeping sound 10 seconds after operation. 

Changing the wide screen mode

You can select a desired mode for enlarging a 4:3 picture to a 16:9 one.

- **Press WIDE to select the desired setting.**

Press **WIDE** repeatedly to switch between the following settings:

FULL (full)—**JUST** (just)—**CINEMA** (cinema)
—**ZOOM** (zoom)—**NORMAL** (normal)

- When a Pioneer navigation unit is connected to this unit, press **WIDE** and hold to select the desired setting. Press and hold **WIDE** repeatedly to switch between the settings.

FULL (full)

A 4:3 picture is enlarged in the horizontal direction only, giving you a 4:3 TV picture (normal picture) without any omissions.

JUST (just)

The picture is enlarged slightly at the center and the amount of enlargement increases horizontally

to the ends, enabling you to enjoy a 4:3 picture without sensing any disparity even on a wide screen.

CINEMA (cinema)

The picture is enlarged by the same proportion as **FULL** or **ZOOM** in the horizontal direction and by an intermediate proportion between **FULL** and **ZOOM** in the vertical direction; ideal for a cinema-sized picture (wide screen picture) where captions lie outside.

ZOOM (zoom)

A 4:3 picture is enlarged in the same proportion both vertically and horizontally; ideal for a cinema-sized picture (wide screen picture).

NORMAL (normal)

A 4:3 picture is displayed as it is, giving you no sense of disparity since its proportions are the same as that of the normal picture.



Notes

- Different settings can be memorized for each video source.
- When video is viewed in a wide screen mode that does not match its original aspect ratio, it may appear different.
- Remember that using the wide mode feature of this system for commercial or public viewing purposes may constitute an infringement on the author's rights protected by the Copyright Law.
- Video will appear grainy when viewed in **CINEMA** or **ZOOM** mode.
- The navigation map and the rear view camera picture is always **FULL**. 

Adjusting the picture adjustment

You can adjust **BRIGHT** (brightness), **CONTRAST** (contrast), **COLOR** (color) and

Basic Operations

HUE (hue) for each source and rear view camera.

- The adjustments of **BRIGHT** and **CONTRAST** are stored separately for light ambient (daytime) and dark ambient (nighttime). A sun ☀ or moon 🌙 is displayed to the left of **BRIGHT** and **CONTRAST**, respectively, as the ambient light sensor determines brightness or darkness.
- You cannot adjust **HUE** for PAL video.
- You cannot adjust **COLOR** or **HUE** for the audio source.
- This unit detects whether your vehicle's parking brake is engaged or not, and prevents you from adjusting the picture adjustment while driving. When you attempt to adjust the picture adjustment, the warning **YOU CANNOT USE THIS FUNCTION WHILE DRIVING** will appear on the display and indicate that the picture adjustment cannot be used.

1 Press V.ADJ and hold to display PICTURE ADJUST.

Press **V.ADJ** until **PICTURE ADJUST** appears in the display.

2 Touch any of the following touch panel keys to select the function to be adjusted.

The adjustment function names are displayed and adjustable ones are highlighted.

- **BRIGHT** – Adjust the black intensity
 - **CONTRAST** – Adjust the contrast
 - **COLOR** – Adjust the color saturation
 - **HUE** – Adjust the tone of color (red is emphasized or green is emphasized)
 - **DIMMER** – Adjust the brightness of display
 - **BACK-CAMERA** – Switch to the picture adjustment display for the rear view camera
 - **SOURCE** – Return to the picture adjustment display for each source
- You can adjust the picture adjustment for rear view camera only when **B. CAMERA** is turned on. (Refer to *Setting for rear view camera* on page 65.)

- **SOURCE** will appear in the display instead of **BACK-CAMERA** when you select **BACK-CAMERA**.

- With some rear view cameras, picture adjustment may not be possible.

3 Touch ◀ or ▶ to adjust the selected item.

Each time you touch ◀ or ▶ it increases or decreases the level of selected item. **+24** – **-24** is displayed as the level is increased or decreased.

4 Touch ESC to hide the touch panel keys.

Adjusting the dimmer

The adjustment of **DIMMER** is stored separately for each ambient light; daytime, evening and nighttime. The brightness of LCD screen will be adjusted to optimum level automatically in accordance with the ambient light based on the setting values.

1 Press V.ADJ and hold to display PICTURE ADJUST.

Press **V.ADJ** until **PICTURE ADJUST** appears in the display.

2 Touch DIMMER.

The ambient light level used as the standard for adjusting **DIMMER** appears above the level bar.

- Yellow sun ☀ – Adjust the brightness for bright ambient light (daytime)
- Red sun 🌅 – Adjust the brightness for intermediate brightness (evening)
- Blue moon 🌙 – Adjust the brightness for dark ambient light (nighttime)

3 Touch ◀ or ▶ to adjust the brightness.

Each time you touch ◀ or ▶ moves yellow towards the left or the right.

The level indicates the brightness of the screen being adjusted. The farther yellow moves to the right, the brighter the screen.

4 Touch ESC to hide the touch panel keys.



Note

The icons indicating the current ambient brightness used for adjusting **BRIGHT** and **CONTRAST** may differ from **DIMMER** slightly. 

Protecting your unit from theft

The front panel can be detached from this unit to discourage theft.

- If the front panel is not detached from this unit within five seconds of turning off the ignition, a warning tone will sound.
- Only when using this unit with ADD-ON mode (**M**), you can operate this function.
- You can turn off the warning tone. See *Switching the warning tone* on page 63.



Important

- Never use force or grip the display and the buttons too tightly when removing or attaching.
- Avoid subjecting the front panel to excessive shocks.
- Keep the front panel out of direct sunlight and high temperatures.
- If removed, replace the front panel on the unit before starting up your vehicle.

Removing the front panel

- Move downward **RELEASE** and remove the front panel toward you.

Take care not to grip it too tightly or to drop the front panel and protect it from contact

with water or other fluids to prevent permanent damage.

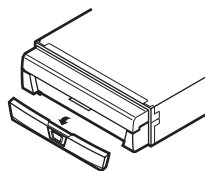

Attaching the front panel

- Replace the front panel by clipping it into place.

Align the groove on the bottom of the front panel with the guide on the display unit.

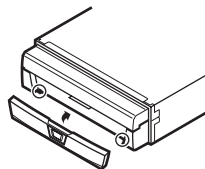

- Press **RELEASE** until the front panel clicks into place. 

Playing DVD video discs

Watching a DVD video

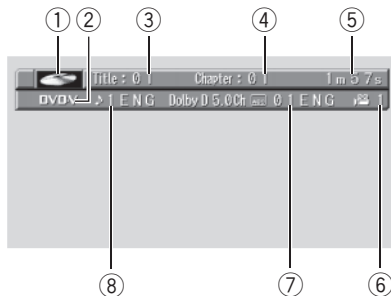

These are the basic steps necessary to play a DVD video with your DVD player. More advanced DVD video operation is explained starting on page 29.

- ① **Source icon**
Shows which source has been selected.
- ② **DVD-V indicator**
Shows when a DVD video is playing.
- ③ **Title number indicator**
Shows the title currently playing.
- ④ **Chapter number indicator**
Shows the chapter currently playing.
- ⑤ **Play time indicator**
Shows the elapsed playing time of the current chapter.
- ⑥ **Viewing angle indicator**
Shows which viewing angle has been selected.
- ⑦ **Subtitle language indicator**
Shows which subtitle language has been selected.

⑧ Audio language indicator

Shows which audio language has been selected.

1 Press AV SOURCE to select the DVD player.

Press **AV SOURCE** until DVD player is selected as the source.

- If no disc is loaded in the unit, you cannot select the DVD player. Insert a disc in the unit. (Refer to page 20.)
- With some discs, a menu may be displayed. (Refer to *Operating the DVD menu* on the next page.)

2 Touch the screen to display the touch panel keys.

3 To skip back or forward to another chapter, touch I◀◀ or ▶▶I.

Touching ▶▶I skips to the start of the next chapter. Touching I◀◀ once skips to the start of the current chapter. Touching it again will skip to the previous chapter. Chapter numbers are displayed for eight seconds.

- You can also skip back or forward to another chapter by moving the joystick left or right.

4 Touch → to display ◀◀ and ▶▶.

Touch → until ◀◀ and ▶▶ appear in the display.

5 To perform fast forward or reverse, keep touching ◀◀ or ▶▶.

If you keep touching ◀◀ or ▶▶ for five seconds, the icon ◀◀ or ▶▶ changes into reversal indication. When this happens, fast reverse/fast forward continues even if you release ◀◀ or ▶▶. To resume playback at a desired point, touch ▶/II.

- You can also perform fast reverse/fast forward by holding the joystick left or right.

- Fast forward/fast reverse may not be possible at certain locations on some discs. If this happens, normal playback automatically resumes.

**Note**

If you do not use the touch panel keys within 30 seconds, they will be hidden automatically. 

Operating the DVD menu

Some DVDs allow you to select from the disc contents using a menu.

- You can display the menu by touching **MENU** or **TOP.M** while a disc is playing. Touching either of these keys again lets you start playback from the location selected from the menu. For details, refer to the instructions provided with the disc.
- If you switch the remote control operation mode to **DVD**, the joystick on the remote control can also operate the DVD menu. (Refer to page 17.)

1 Touch to display touch panel keys to operate the DVD menu.

- When the touch panel keys are not displayed, you can display them by touching the screen.

2 Touch , , or to select the desired menu item.



3 Touch **ENTER**.

Playback starts from the selected menu item.

- The way to display the menu differs depending on the disc. 

Skipping back or forward to another title

- To skip back or forward to another title, touch  or .

Touching  skips to the start of the next title. Touching  skips to the start of the previous title.

Title numbers are displayed for eight seconds.

- You can also skip back or forward to another title by moving the joystick up or down. 

Stopping playback

- Touch .

▪ When you stop DVD playback by touching , that location on the disc is memorized, enabling playback from that point when you play the disc again.

- To play back the disc again, touch . 

Playing DVD video discs

Introduction of advanced DVD video operation

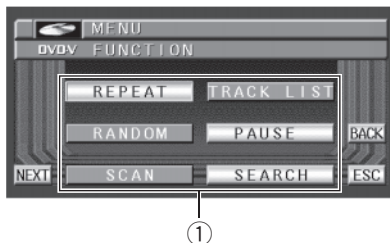

① Function display

Shows the function names.

● Touch **A.MENU** and then touch **FUNCTION** to display the function names.

The function names are displayed and operable ones are highlighted.

- When **A.MENU** is not displayed, you can display it by touching the screen.
- You can also display **MENU** by clicking the joystick.
- To go to the next group of function names, touch **NEXT**.
- To return to the previous group of function names, touch **PREV**.
- To return to the previous display, touch **BACK**.
- To return to the playback display, touch **ESC**.



Note

If you do not operate the function within about 30 seconds, the display is automatically returned to the playback display.

Repeating play

There are three repeat play ranges for the DVD playback: **DISC** (disc repeat), **TITLE** (title repeat) and **CHAPTER** (chapter repeat).

1 Touch **A.MENU** and **FUNCTION** and then touch **REPEAT**.

2 Touch any of the following touch panel keys to select the repeat range.

- **TITLE** – Repeat just the current title
- **CHAPTER** – Repeat just the current chapter
- **DISC** – Play through the current disc



Notes

- If you perform chapter search or fast forward/reverse, the repeat play range changes to **DISC**.
- You cannot operate repeating play when **DVD D. AUTO** is on (refer to *Automatic playback of DVDs* on page 61).

Pausing DVD video playback

Pause lets you temporarily stop disc playback.

● Touch **▶/II** during playback.

The icon **II** is displayed and playback is paused, letting you view a still image.

- To resume playback at the same point that you turned pause on, touch **▶/II** again.



Notes

- You can also turn pause function on or off using **PAUSE**. To display **PAUSE**, touch **A.MENU** and then touch **FUNCTION**.
- Depending on the disc and the playback location on the disc, the icon may be displayed, indicating that still playback is not possible.

Frame-by-frame playback

This lets you move ahead one frame at a time during playback.



Playing DVD video discs

● Touch **II▶** during playback.

Each time you touch **II▶**, you move ahead one frame.

- To return to normal playback, touch **▶/II**.

Notes

- Depending on the disc and the playback location on the disc, the icon  may be displayed, indicating that frame-by-frame playback is not possible.
- With some discs, images may be unclear during frame-by-frame playback. 

Slow motion playback

This lets you slow down playback speed.

1 Keep touching **II▶** until **▶▶** is displayed during playback.



The icon **▶▶** is displayed, forward slow motion playback begins.

- To return to normal playback, touch **▶/II**.

2 Touch **◀II** or **II▶** to adjust playback speed during slow motion playback.

Each time you touch **◀II** or **II▶** it changes the speed in four steps in the following order:
1/16—1/8—1/4—1/2

Notes

- There is no sound during slow motion playback.
- Depending on the disc and the playback location on the disc, the icon  may be displayed, indicating that slow motion playback is not possible.
- With some discs, images may be unclear during slow motion playback.
- Reverse slow motion playback is not possible. 

Searching for a desired scene, starting playback from a specified time

You can use the search function to search for a desired scene by specifying a title or chapter, and the time search function to specify the time on a disc at which play starts.

- Chapter search and time search are not possible when disc playback has been stopped.

1 Touch **A.MENU** and **FUNCTION** and then **SEARCH**.

2 Touch **TITLE** (title), **CHAPTER** (chapter) or **TIME** (time).

3 Touch **0—9** to input the desired number.

For titles and chapters

- To select 3, touch **3**.
- To select 10, touch **1** and **0** in that order.
- To select 23, touch **2** and **3** in that order.

For time (time search)

- To select 21 minutes 43 seconds, touch **2**, **1**, **4** and **3** in that order.
- To select 1 hour 11 minutes, convert the time into 71 minutes 00 seconds and touch **7**, **1**, **0** and **0** in that order.
- To cancel the inputted numbers, touch **C**.
- You can also input the desired number by using the joystick and **0-9**.

4 While the inputted number is displayed, touch **ENTER**.

This starts playback from the selected scene.

Notes

- With discs featuring a menu, you can also touch **MENU** or **TOP.M** and then make selections from the displayed menu.

Playing DVD video discs

- With some discs, the icon  may be displayed, indicating that titles, chapters and time cannot be specified.

Specifying title

You can use the direct search function to search for a desired scene by specifying a title.

- Only the remote control can operate this function. To perform this function, switch the remote control operation mode to **DVD**. (Refer to page 17.)

- **Press 0–10 corresponding to a desired title number when the disc is stopped.**

Title number is displayed for eight seconds and playback starts from the selected title.

- To select 3, press **3**.
- To select 10, press **10** and **0** in that order.
- To select 23, press **10**, **10** and **3** in that order. 

Changing audio language during playback (Multi-audio)

DVDs can provide audio playback with different languages and different systems (Dolby Digital, DTS etc.). With DVDs featuring multi-audio recordings, you can switch between languages/audio systems during playback.

- **Touch AUDIO during playback.**

Each time you touch **AUDIO** it switches between audio systems.

Notes

- The number in the  mark on a DVD's package indicates the number of recorded languages/audio systems.
- With some DVDs, switching between languages/audio systems may only be possible using a menu display.

- You can also switch between languages/audio systems using **DVD SETUP**. For details, refer to *Setting the audio language* on page 58.
- Only digital output of DTS audio is possible. If this unit's optical digital outputs are not connected, DTS audio will not be output, so select an audio setting other than DTS.
- Display indications such as **Dolby D** and **5.1ch** indicate the audio system recorded on the DVD. Depending on the setting, playback may not be with the same audio system as that indicated.
- Touching **AUDIO** during fast forward/fast reverse, pause or slow motion playback returns you to normal playback. 



Changing the subtitle language during playback (Multi-subtitle)

With DVDs featuring multi-subtitle recordings, you can switch between subtitle languages during playback.

- **Touch SUB.T during playback.**

Each time you touch **SUB.T** it switches between subtitle languages.

Notes

- The number in the  mark on a DVD's package indicates the number of recorded subtitle languages.
- With some DVDs, switching between subtitle languages may only be possible using a menu display.
- You can also switch between subtitle languages using **DVD SETUP**. For details, refer to *Setting the subtitle language* on page 57.
- Touching **SUB.T** during fast forward/fast reverse, pause or slow motion playback returns you to normal playback. 

Changing the viewing angle during playback (Multi-angle)



With DVDs featuring multi-angle (scenes shot from multiple angles) recordings, you can switch among viewing angles during playback.

- During playback of a scene shot from multiple angles, the angle icon  is displayed. Turn angle icon display on or off using **DVD SETUP**. For details, refer to *Setting angle icon display* on page 59.

- **Touch ANGLE during playback of a scene shot from multiple angles.**

Each time you touch **ANGLE** it switches between angles.

Notes

- The  mark on a DVD's package indicates it features multi-angle scenes. The number in the  mark indicates the number of angles from which scenes were shot.
- Touching **ANGLE** during fast forward/fast reverse, pause or slow motion playback returns you to normal playback. 

Resume playback (Bookmark)

The Bookmark function lets you resume playback from a selected scene the next time the disc is loaded.

- To perform this function, switch the remote control operation mode to **DVD**. (Refer to page 17.)

- **During playback, press BOOKMARK (BOOK.M) at the point you want to resume playback next time.**

The selected scene will be bookmarked so that playback resumes from that point next time. You can bookmark up to five discs. After that,

the oldest bookmark is replaced by the new one.

- To clear the bookmark on a disc, press and hold **BOOKMARK (BOOK.M)** during playback.
- You can also bookmark a disc by pressing and holding **EJECT** at the point you want to bookmark. Next time you load the disc, playback will resume from the bookmarked point. Note that you can only bookmark one disc using this method. To clear the bookmark on a disc, press **EJECT**. 

Selecting audio output

You can switch between stereo and monaural audio output.



- This function is possible only with Linear PCM sound.
- This function is not possible when disc playback has been stopped.

- 1 **Touch A.MENU and FUNCTION and then touch NEXT.**

- 2 **Touch L/R SELECT.**

- 3 **Touch L+R (left and right), LEFT (left) or RIGHT (right).**

Note

Depending on the disc and the playback location on the disc, the icon  may be displayed, indicating that operating this function is not possible. 

Playing Video CDs

Watching a Video CD

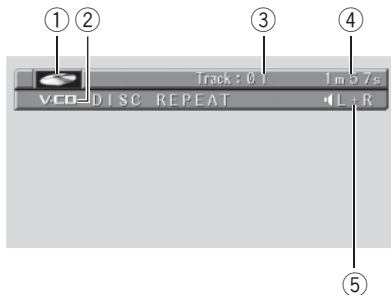

These are the basic steps necessary to play a Video CD with your DVD player. More advanced Video CD operation is explained starting on page 35.

- ① **Source icon**
Shows which source has been selected.
- ② **V-CD indicator**
Shows when a Video CD is playing.
- ③ **Track number indicator**
Shows the track currently playing.
- ④ **Play time indicator**
Shows the elapsed playing time of the current track.
- ⑤ **Audio output indicator**
Shows the output channel selected currently.

1 Press AV SOURCE to select the DVD player.

Press **AV SOURCE** until DVD player is selected as the source.

- If no disc is loaded in the unit, you cannot select the DVD player. Insert a disc in the unit. (Refer to page 20.)

- With a Video CD featuring the PBC (playback control) function, a menu is displayed.

2 Switch the remote control operation mode to DVD and then press 0–10 to select the desired menu item.

Playback starts from the selected menu item.

- When the menu is two or more pages long, touch **◀◀** or **▶▶** to switch between displays.
- You can display the menu by pressing **RETURN** during PBC playback. For details, refer to the instructions provided with the disc.
- After operating the menu, we recommend that you switch remote control operation mode to **AVX**. (Refer to page 17.)

3 Touch the screen to display the touch panel keys.

4 To skip back or forward to another track, touch ◀◀ or ▶▶.

Touching **▶▶** skips to the start of the next track. Touching **◀◀** once skips to the start of the current track. Touching it again will skip to the previous track.

Track numbers are displayed for eight seconds.

- You can also skip back or forward to another track by moving the joystick left or right.
- During PBC playback, a menu may be displayed if you perform these operations.

5 Touch → to display ◀◀ and ▶▶.

Touch **→** until **◀◀** and **▶▶** appear in the display.

6 To perform fast forward or reverse, keep touching ◀◀ or ▶▶.

If you keep touching **◀◀** or **▶▶** for five seconds, the icon **◀◀** or **▶▶** changes into reversal indication. When this happens, fast reverse/fast forward continues even if you release **◀◀** or **▶▶**. To resume playback at a desired point, touch **▶/||**.

- You can also perform fast reverse/fast forward by holding the joystick left or right.
- Fast forward/fast reverse may not be possible at certain locations on some discs. If this happens, normal playback automatically resumes.

**Note**

If you do not use the touch panel keys within 30 seconds, they will be hidden automatically. 

PBC playback

During playback of Video CDs featuring PBC (Playback Control), **PBC ON** is displayed. During such playback, search and time search functions cannot be used nor can you select the range for repeat play.

**Note**

PBC playback of Video-CD cannot be cancelled. 

Operating the menu

With Video CDs featuring PBC (playback control) function, you can operate a menu.

- **Switch the remote control operation mode to DVD and then press 0-10 to select the desired menu item.**

Playback starts from the selected menu item.

- When the menu is two or more pages long, touch **◀◀** or **▶▶** to switch between displays.
- You can display the menu by pressing **RETURN** during PBC playback. For details, refer to the instructions provided with the disc.
- After operating the menu, we recommend that you switch remote control operation mode to **AVX**. (Refer to page 17.) 

Stopping playback

- **Touch ■.**
 - When you stop Video CD playback (during PBC playback only) by touching **■**, that location on the disc is memorized, enabling playback from that point when you play the disc again.
 - To play back the disc again, touch **▶/||**. 

Playing Video CDs

Introduction of advanced Video CD operation

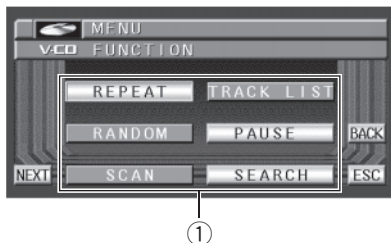

① Function display

Shows the function names.

● Touch **A.MENU** and then touch **FUNCTION** to display the function names.

The function names are displayed and operable ones are highlighted.

- When **A.MENU** is not displayed, you can display it by touching the screen.
- You can also display **MENU** by clicking the joystick.
- To go to the next group of function names, touch **NEXT**.
- To return to the previous group of function names, touch **PREV**.
- To return to the previous display, touch **BACK**.
- To return to the playback display, touch **ESC**.



Note

If you do not operate the function within about 30 seconds, the display is automatically returned to the playback display. □

Repeating play

There are two repeat play ranges for the Video CD playback: **TRACK** (track repeat) and **DISC** (disc repeat).

- During playback of Video CDs featuring PBC (playback control), this function cannot be operated.

1 Touch **A.MENU** and **FUNCTION** and then touch **REPEAT**.

2 Touch either of the following touch panel keys to select the repeat range.

- **TRACK** – Repeat just the current track
- **DISC** – Repeat the current disc



Note

If you perform track search or fast forward/reverse, the repeat play range changes to **DISC**. □

Pausing Video CD playback

Pause lets you temporarily stop disc playback.

● Touch **▶/II** during playback.

The icon **II** is displayed and playback is paused, letting you view a still image.

- To resume playback at the same point that you turned pause on, touch **▶/II** again.



Notes

- You can also turn pause function on or off using **PAUSE**. To display **PAUSE**, touch **A.MENU** and then touch **FUNCTION**.
- Depending on the disc and the playback location on the disc, the icon **⊖** may be displayed, indicating that still playback is not possible. □

Frame-by-frame playback



This lets you move ahead one frame at a time during playback.

- **Touch **II▶** during playback.**

Each time you touch **II▶**, you move ahead one frame.

- To return to normal playback, touch **▶/II**.

Notes

- Depending on the disc and the playback location on the disc, the icon  may be displayed, indicating that frame-by-frame playback is not possible.
- With some discs, images may be unclear during frame-by-frame playback. 

Slow motion playback

This lets you slow down playback speed.

1 Keep touching **II▶** until **▶▶** is displayed during playback.



The icon **▶▶** is displayed, forward slow motion playback begins.

- To return to normal playback, touch **▶/II**.

2 Touch **◀II** or **II▶** to adjust playback speed during slow motion playback.

Each time you touch **◀II** or **II▶** it changes the speed in four steps in the following order: 1/16—1/8—1/4—1/2

Notes

- There is no sound during slow motion playback.
- Depending on the disc and the playback location on the disc, the icon  may be displayed, indicating that slow motion playback is not possible.
- With some discs, images may be unclear during slow motion playback.
- Reverse slow motion playback is not possible. 

Searching for a desired scene, starting playback from a specified time

You can use the search function to search for a desired scene by specifying a track, and the time search function to specify the time on a disc at which play starts.

- During playback of Video CDs featuring PBC (playback control), this function cannot be operated.
- Time search is not possible when disc playback has been stopped.

1 Touch **A.MENU** and **FUNCTION** and then **SEARCH**.

2 Touch **TRACK (track)** or **TIME (time)**.

3 Touch **0—9** to input the desired number.

For tracks

- To select 3, touch **3**.
- To select 10, touch **1** and **0** in that order.
- To select 23, touch **2** and **3** in that order.

For time (time search)

- To select 21 minutes 43 seconds, touch **2**, **1**, **4** and **3** in that order.
- To select 1 hour 11 minutes, convert the time into 71 minutes 00 seconds and touch **7**, **1**, **0** and **0** in that order.
- To cancel the inputted numbers, touch **C**.
- You can also input the desired number by using the joystick and **0-9**.

4 While the inputted number is displayed, touch **ENTER**.

This starts playback from the selected scene. 

Selecting audio output

You can switch between stereo and monaural audio output.

- **Press AUDIO during playback.**

Press **AUDIO** repeatedly to switch between the following outputs:

L+R (left and right channels)—**L** (left channel)

—**R** (right channel)



Note

You can also perform the same operations using

L/R SELECT. To display **L/R SELECT**, touch

A.MENU and **FUNCTION** and then touch

NEXT. 

Listening to a CD

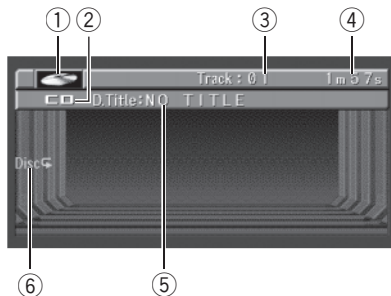

These are the basic steps necessary to play a CD with your DVD player. More advanced CD operation is explained starting on the next page.

- ① **Source icon**
Shows which source has been selected.
- ② **CD indicator**
Shows when a CD is playing.
- ③ **Track number indicator**
Shows the track currently playing.
- ④ **Play time indicator**
Shows the elapsed playing time of the current track.
- ⑤ **Disc title indicator**
Shows the title of the currently playing disc.
- ⑥ **Repeat indicator**
Shows when repeat range is selected to current track.

1 Press AV SOURCE to select the DVD player.

Press **AV SOURCE** until DVD player is selected as the source.

- If no disc is loaded in the unit, you cannot select the DVD player. Insert a disc in the unit. (Refer to page 20.)

2 Touch the screen to display the touch panel keys.

3 To skip back or forward to another track, touch ◀◀ or ▶▶.

Touching ▶▶ skips to the start of the next track. Touching ◀◀ once skips to the start of the current track. Touching it again will skip to the previous track.

- You can also skip back or forward to another track by moving the joystick left or right.

4 Touch → to display ◀◀ and ▶▶.

Touch → until ◀◀ and ▶▶ appear in the display.

5 To perform fast forward or reverse, keep touching ◀◀ or ▶▶.

- You can also perform fast reverse/fast forward by holding the joystick left or right.



Notes

- When playing discs with MP3/WMA files and audio data (CD-DA) such as CD-EXTRA and MIXED-MODE CDs, both types can be played only by switching mode between MP3/WMA and CD-DA by touching **DA-ROM** or pressing **BAND/ESC**. This function can be operated only when the disc is playing.
- If you do not use the touch panel keys within 30 seconds, they will be hidden automatically. □

Stopping playback

● Touch ■.

- When you stop CD playback by touching ■, that location on the disc is memorized, enabling

Playing CDs

playback from that point when you play the disc again.

- To play back the disc again, touch ►/II. ◻

Introduction of advanced CD operation

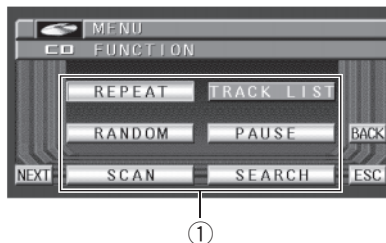

① Function display

Shows the function names.

- **Touch A.MENU and then touch FUNCTION to display the function names.**

The function names are displayed and operable ones are highlighted.

- When **A.MENU** is not displayed, you can display it by touching the screen.
- You can also display **MENU** by clicking the joystick.
- To go to the next group of function names, touch **NEXT**.
- To return to the previous group of function names, touch **PREV**.
- To return to the previous display, touch **BACK**.
- To return to the playback display, touch **ESC**.



Note

If you do not operate the function within about 30 seconds, the display is automatically returned to the playback display. ◻

Repeating play

Repeat play lets you hear the same track over again.

1 Touch A.MENU and FUNCTION and then touch REPEAT.

2 Touch either of the following touch panel keys to select the repeat range.

- **TRACK** – Repeat just the current track
- **DISC** – Repeat the current disc



Notes

- If you perform track search or fast forward/reverse, repeat play is automatically cancelled.
- When playing discs with MP3/WMA files and audio data (CD-DA), repeat play performs within the currently playing data type even if **DISC** is selected.

Playing tracks in a random order

Random play lets you play back tracks on the CD in a random order.

1 Touch A.MENU and FUNCTION and then touch RANDOM.

2 Touch ▲ to turn random play on.

Tracks will play in a random order.

- To turn random play off, touch ▼.

Scanning tracks of a CD

Scan play lets you hear the first 10 seconds of each track on the CD.

1 Touch A.MENU and FUNCTION and then touch SCAN.

2 Touch ▲ to turn scan play on.

The first 10 seconds of each track is played.



3 When you find the desired track touch ▼ to turn scan play off.



Note

After scanning of a CD is finished, normal playback of the tracks will begin again.

Pausing CD playback

Pause lets you temporarily stop disc playback.

● **Touch ►/|| during playback.**

PAUSE is displayed and playback is paused.

- To resume playback at the same point that you turned pause on, touch ►/|| again.



Note

You can also turn pause function on or off using **PAUSE**. To display **PAUSE**, touch **A.MENU** and then touch **FUNCTION**.

Searching for a desired track

You can use the search function to specify a track to search for a desired track.

1 Touch A.MENU and FUNCTION and then SEARCH.

2 Touch TRACK.

3 Touch 0—9 to input the desired number.

- To select 3, touch **3**.
- To select 10, touch **1** and **0** in that order.
- To select 23, touch **2** and **3** in that order.
- To cancel the inputted numbers, touch **C**.
- You can also input the desired number by using the joystick and **0-9**.

Playing CDs

4 While the inputted number is displayed, touch ENTER.

This starts playback from the selected track. 

Entering disc titles

You can input CD titles and display the title. The next time you insert a CD for which you have entered a title, the title of that CD will be displayed.

Use the disc title input feature to store up to 48 CD titles in the unit. Each title can be up to 10 characters long.

- When playing a CD TEXT disc, you cannot switch to **TITLE EDIT**. The disc title will have already been recorded on a CD TEXT disc.
- If no title has been entered for the currently playing disc, **NO TITLE** is displayed.

1 Play the CD that you want to enter a title for.

2 Touch A.MENU and FUNCTION and then touch NEXT.

3 Touch TITLE EDIT.

4 Touch ABC to select the desired character type.

Touch **ABC** repeatedly to switch between the following character types:

Alphabet (upper case), numbers and symbols
—Alphabet (lower case)—European letters, such as those with accents (e.g., á, à, ã, ç)

- You can select to input numbers and symbols by touching **123**.

5 Touch ▲ or ▼ to select a letter of the alphabet.

Each time you touch ▲ it will display a letter of the alphabet in **A B C ... X Y Z**, numbers and symbols in **1 2 3 ... }** order. Each time you

touch ▼ it will display a letter in the reverse order, such as **Z Y X ... C B A**.



6 Touch ► to move the cursor to the next character position.

When the desired letter is displayed, touch ► to move the cursor to the next position and then select the next letter. Touch ◀ to move backwards in the display.

7 Touch OK to store the entered title in memory.

8 Touch ESC to return to the playback display.



Notes

- Titles remain in memory, even after the disc has been removed from the unit, and are recalled when the disc is reinserted.
- After data for 48 discs has been stored in memory, data for a new disc will overwrite the oldest one. 

Using CD TEXT functions

Some discs have certain information encoded on the disc during manufacture. These discs may contain such information as the CD title, track title, artist's name and playback time and are called CD TEXT discs. Only these specially encoded CD TEXT discs support the functions listed below.

Displaying titles on CD TEXT discs

● Touch DISP.

Touch **DISP** repeatedly to switch between the following settings:

D.Title (disc title)—**D.Artist** (disc artist name)

—**T.Title** (track title)—**T.Artist** (track artist name)

- If specific information has not been recorded on a CD TEXT disc, **NO XXXX** will be displayed (e.g., **NO ARTIST**).

Scrolling titles in the display

This unit can display the first 19 letters only of **D.Title**, **D.Artist**, **T.Title** and **T.Artist**. When the recorded information is longer than 19 letters, you can scroll the text to the left so that the rest of the title can be seen.

● Keep touching DISP until the title begins to scroll to the left.

The rest of the title will appear in the display.

Selecting tracks from the track title list

Track title list lets you see the list of track titles on a CD TEXT disc and select one of them to play back.

1 Touch A.MENU and FUNCTION and then touch TRACK LIST.

2 Touch PREV or NEXT to switch between the lists of titles.

3 Touch your favorite track title.

That selection will begin to play. 

Playing MP3/WMA

Listening to MP3/WMA

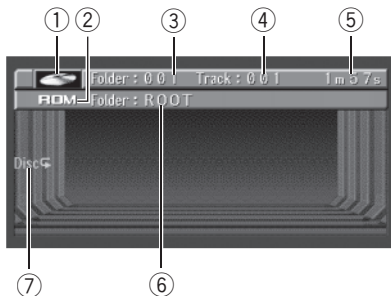

These are the basic steps necessary to play an MP3/WMA with your built-in DVD player. More advanced MP3/WMA operation is explained starting on page 45.

① Source icon

Shows which source has been selected.

② ROM indicator

Shows when the MP3/WMA file is playing. When playing discs with MP3/WMA files and audio data (CD-DA) such as CD-EXTRA and MIXED-MODE CDs, **CD-ROM** is displayed.

③ Folder number indicator

Shows the number of folder currently playing.

④ Track number indicator

Shows the track (file) currently playing.

⑤ Play time indicator

Shows the elapsed playing time of the current track (file).

⑥ Folder name indicator

Shows the name of folder currently playing.

⑦ Repeat indicator

Shows the selected repeat range.

1 Press AV SOURCE to select the DVD player.

Press **AV SOURCE** until DVD player is selected as the source.

- If no disc is loaded in the unit, you cannot select the DVD player. Insert a disc in the unit. (Refer to page 20.)

2 Touch the screen to display the touch panel keys.

3 To skip back or forward to another track, touch ◀◀ or ▶▶.

Touching ▶▶ skips to the start of the next track. Touching ◀◀ once skips to the start of the current track. Touching it again will skip to the previous track.

- You can also skip back or forward to another track by moving the joystick left or right.

4 Touch → to display ▲, ▼, ◀◀ and ▶▶.

Touch → until ▲, ▼, ◀◀ and ▶▶ appear in the display.

5 To perform fast forward or reverse, keep touching ◀◀ or ▶▶.

- You can also perform fast reverse/fast forward by holding the joystick left or right.
- There is no sound on fast forward or reverse.
- This is fast forward and reverse operation only for the file being played. This operation is canceled when the previous or next file is reached.

6 Touch ▲ or ▼ to select a folder.

- You can also select a folder by moving the joystick up or down.
- To return to folder **001** (ROOT), press and hold **BAND/ESC**. However, if folder **001** (ROOT) contains no files, playback commences with folder **002**.
- You cannot select a folder that does not have an MP3/WMA file recorded in it.

**Notes**

- When playing discs with MP3/WMA files and audio data (CD-DA) such as CD-EXTRA and MIXED-MODE CDs, both types can be played only by switching mode between MP3/WMA and CD-DA by touching **DA-ROM** or pressing **BAND/ESC**. This function can be operated only when the disc is playing.
- If you have switched between playback of MP3/WMA files and audio data (CD-DA), playback starts at the first track on the disc.
- This DVD player can play back an MP3/WMA file recorded on CD-ROM. (Refer to page 75 for files that can be played back.)
- There is sometimes a delay between starting up CD playback and the sound being issued. When being read in, **FORMAT READ** is displayed.
- Playback is carried out in order of file number. Folders are skipped if they contain no files. (If folder **001** (ROOT) contains no files, playback commences with folder **002**.)
- This unit does not play back WMA files recorded as VBR (variable bit rate).
- When playing back files recorded as VBR (variable bit rate) files, the play time will not be correctly displayed if fast forward or reverse operations are used.
- If the inserted disc contains no files that can be played back, **NO AUDIO** is displayed.
- If the inserted disc contains WMA files that are protected by digital rights management (DRM), **TRK SKIPPED** is displayed while the protected file is skipped.
- If all the files on the inserted disc are secured by DRM, **PROTECT** is displayed.
- When a disc contains both WMA files which are protected by DRM and audio data (CD-DA), both types cannot be switched. In this case, only audio data will be played back.
- There is no sound on fast forward or reverse.
- If you do not use the touch panel keys within 30 seconds, they will be hidden automatically.

Stopping playback

- **Touch** .
 - When you stop MP3/WMA playback by touching , that location on the disc is memorized, enabling playback from that point when you play the disc again.
 - To play back the disc again, touch **▶/||**.

Playing MP3/WMA

Introduction of advanced built-in DVD player (MP3/WMA) operation

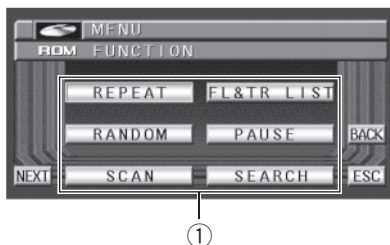

① Function display

Shows the function names.

● Touch **A.MENU** and then touch **FUNCTION** to display the function names.

The function names are displayed and operable ones are highlighted.

- When **A.MENU** is not displayed, you can display it by touching the screen.
- You can also display **MENU** by clicking the joystick.
- To go to the next group of function names, touch **NEXT**.
- To return to the previous group of function names, touch **PREV**.
- To return to the previous display, touch **BACK**.
- To return to the playback display, touch **ESC**.



Note

If you do not operate the function within about 30 seconds, the display is automatically returned to the playback display. 

Repeating play

For MP3/WMA playback, there are three repeat play ranges: **FOLDER** (folder repeat),

TRACK (one-track repeat) and **DISC** (repeat all tracks).

1 Touch A.MENU and FUNCTION and then touch REPEAT.

2 Touch any of the following touch panel keys to select the repeat range.

- **TRACK** – Repeat just the current track
- **FOLDER** – Repeat the current folder
- **DISC** – Repeat all tracks



Notes

- If you select another folder during repeat play, the repeat play range changes to **DISC**.
- If you perform track search or fast forward/reverse during **TRACK**, the repeat play range changes to **FOLDER**.
- When **FOLDER** is selected, it is not possible to play back a subfolder of that folder.
- When playing discs with MP3/WMA files and audio data (CD-DA), repeat play performs within the currently playing data type even if **DISC** is selected. 

Playing tracks in a random order

Random play lets you play back tracks in a random order within the repeat range, **FOLDER** and **DISC**.

1 Select the repeat range.

Refer to *Repeating play* on this page.

2 Touch A.MENU and FUNCTION and then touch RANDOM.

3 Touch ▲ to turn random play on.

Tracks will play in a random order within the previously selected **FOLDER** or **DISC** ranges.

- To turn random play off, touch ▼. 

Scanning folders and tracks

While you are using **FOLDER**, the beginning of each track in the selected folder plays for about 10 seconds. When you are using **DISC**, the beginning of the first track of each folder is played for about 10 seconds.

1 Select the repeat range.

Refer to *Repeating play* on the previous page.

2 Touch **A.MENU** and **FUNCTION** and then touch **SCAN**.

3 Touch **▲** to turn scan play on.

The first 10 seconds of each track of the current folder (or the first track of each folder) is played.

4 When you find the desired track (or folder) touch **▼** to turn scan play off.



Note

After track or folder scanning is finished, normal playback of the tracks will begin again. 

Pausing MP3/WMA playback

Pause lets you temporarily stop disc playback.

● Touch **▶/||** during playback.

PAUSE is displayed and playback is paused.

- To resume playback at the same point that you turned pause on, touch **▶/||** again.



Note

You can also turn pause function on or off using **PAUSE**. To display **PAUSE**, touch **A.MENU** and then touch **FUNCTION**. 

Searching for a desired track in the current folder

You can use the search function to specify a track to search for a desired track.

- Track search is not possible when disc playback has been stopped.

1 Touch **A.MENU** and **FUNCTION** and then **SEARCH**.

2 Touch **TRACK**.

3 Touch **0—9** to input the desired number.

- To select 3, touch **3**.
- To select 10, touch **1** and **0** in that order.
- To select 23, touch **2** and **3** in that order.
- To cancel the inputted numbers, touch **C**.
- You can also input the desired number by using the joystick and **0-9**.

4 While the inputted number is displayed, touch **ENTER**.

This starts playback from the selected track. 

Displaying text information on MP3/WMA disc

Text information recorded on a MP3/WMA disc can be displayed.

● Touch **DISP**.

Touch **DISP** repeatedly to switch between the following settings:

Folder (folder name)—**File** (file name)
 —**T.Title** (track title)—**Artist** (artist name)
 —**Album** (album title)—**Comment** (comment)
 —**BitRate** (bit rate)

- When playing back WMA files, album title and comment are not displayed.
- When playing back MP3 files recorded as VBR (variable bit rate) files, the bit rate value is not dis-

Playing MP3/WMA

played even after switching to bit rate. (VBR will be displayed.)

- If specific information has not been recorded on an MP3/WMA disc, **NO XXXX** will be displayed (e.g., **NO NAME**). 

Scrolling text information in the display

This unit can display the first 19 letters only of **Folder**, **File**, **T.Title**, **Artist**, **Album** and **Comment**. When the recorded information is longer than 19 letters, you can scroll the text to the left so that the rest of the text information can be seen.

- **Keep touching DISP until the text information begins to scroll to the left.**

The rest of the text information will appear in the display. 

Selecting tracks from the file name list

File name list lets you see the list of file names (or folder names) and select one of them to playback.

1 Touch A.MENU and FUNCTION and then touch FL&TR LIST.



2 Touch PREV or NEXT to switch between the lists of names.

3 Touch your favorite file name (or folder name).

When you select the file, that selection will begin to play.

- When you have selected a folder, a list of the names of the files (or the folders) in it can be

viewed. Repeat 2 and 3 to select the desired file name.

- To return to the previous list (the folder one level higher), touch  .

Listening to a CD

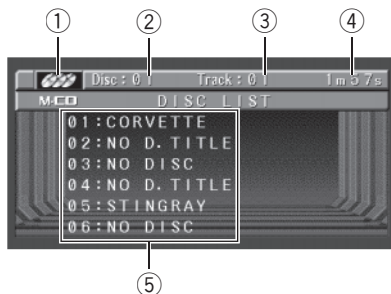

Only when using this unit with ADD-ON mode (M), you can perform the following operations by this unit.

You can use this unit to control a multi-CD player, which is sold separately.

These are the basic steps necessary to play a CD with your multi-CD player. More advanced CD operation is explained starting on the next page.

- ① **Source icon**
Shows which source has been selected.
- ② **Disc number indicator**
Shows the disc currently playing.
- ③ **Track number indicator**
Shows the track currently playing.
- ④ **Play time indicator**
Shows the elapsed playing time of the current track.
- ⑤ **Disc list display**
Shows the disc title list.

1 Touch the source icon and then touch M-CD to select the multi-CD player.

- When the source icon is not displayed, you can display it by touching the screen.

2 Touch the screen to display the touch panel keys.

3 Touch any of 01—06 to select a disc you want to listen to.

If you want to select a disc located at 7 to 12, touch **PREV** or **NEXT** to display **07—12**.

- When **01—06** and **07—12** are not displayed, you can display them by touching **DISP**.
- You can also sequentially select a disc by using **▲/▼**.

4 To skip back or forward to another track, touch ◀ or ▶.

Touching **▶** skips to the start of the next track. Touching **◀** once skips to the start of the current track. Touching again will skip to the previous track.

- You can also skip back or forward to another track by moving the joystick left or right.

5 To perform fast forward or reverse, keep touching ◀ or ▶.

- You can also perform fast reverse/fast forward by holding the joystick left or right.



Notes

- When the multi-CD player performs the preparatory operations, **READY** is displayed.
- If the multi-CD player does not operate properly, an error message such as **ERROR-02** may be displayed. Refer to the multi-CD player owner's manual.
- If there are no discs in the multi-CD player magazine, **NO DISC** is displayed.
- If you do not use the touch panel keys within 30 seconds, they will be hidden automatically.

Multi-CD Player

50-disc multi-CD player

Only those functions described in this manual are supported for 50-disc multi-CD players. This unit is not designed to operate disc title list functions with a 50-disc multi-CD player. 

Introduction of advanced multi-CD player operation

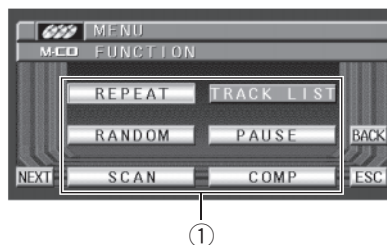

① Function display

Shows the function names.

● Touch **A.MENU** and then touch **FUNCTION** to display the function names.

The function names are displayed and operable ones are highlighted.

- When **A.MENU** is not displayed, you can display it by touching the screen.
- You can also display **MENU** by clicking the joystick.
- To go to the next group of function names, touch **NEXT**.
- To return to the previous group of function names, touch **PREV**.
- To return to the previous display, touch **BACK**.
- To return to the playback display, touch **ESC**.



Note

If you do not operate the function within about 30 seconds, the display is automatically returned to the playback display. 

Repeating play

There are three repeat play ranges for the multi-CD player: **M-CD** (multi-CD player repeat), **TRACK** (one-track repeat) and **DISC** (disc repeat).

1 Touch A.MENU and FUNCTION and then touch REPEAT.

2 Touch ◀▶ to select the repeat range.

Touch ◀▶ repeatedly until the desired repeat range appears in the display.

- **M-CD** – Repeat all discs in the multi-CD player
- **TRACK** – Repeat just the current track
- **DISC** – Repeat the current disc
- You can also select the repeat range by moving the joystick left or right.



Notes

- If you select other discs during repeat play, the repeat play range changes to **M-CD**.
- If you perform track search or fast forward/reverse during **TRACK**, the repeat play range changes to **DISC**. ◻

Playing tracks in a random order

Random play lets you play back tracks in a random order within the repeat range, **M-CD** and **DISC**.

1 Select the repeat range.

Refer to *Repeating play* on this page.

2 Touch A.MENU and FUNCTION and then touch RANDOM.

3 Touch ▲ to turn random play on.

Tracks will play in a random order within the previously selected **M-CD** or **DISC** ranges.

- To turn random play off, touch ▼. ◻

Scanning CDs and tracks

While you are using **DISC**, the beginning of each track on the selected disc plays for about 10 seconds. When you are using **M-CD**, the beginning of the first track of each disc is played for about 10 seconds.

1 Select the repeat range.

Refer to *Repeating play* on this page.

2 Touch A.MENU and FUNCTION and then touch SCAN.

3 Touch ▲ to turn scan play on.

The first 10 seconds of each track of the current disc (or the first track of each disc) is played.

4 When you find the desired track (or disc) touch ▼ to turn scan play off.



Note

After track or disc scanning is finished, normal playback of the tracks will begin again. ◻

Pausing CD playback

Pause lets you temporarily stop disc playback.

1 Touch A.MENU and FUNCTION and then touch PAUSE.

2 Touch ▲ to turn pause on.

Play of the current track pauses.

- To turn pause off, touch ▼. ◻

Multi-CD Player

Using ITS playlists

ITS (Instant track selection) lets you make a playlist of favorite tracks from those in the multi-CD player magazine. After you have added your favorite tracks to the playlist you can turn on ITS play and play just those selections.

Creating a playlist with ITS programming

You can use ITS to enter and play back up to 99 tracks per disc, up to 100 discs (with the disc titles). (With multi-CD players sold before the CDX-P1250 and CDX-P650, up to 24 tracks can be stored in the playlist.)

- 1 Play a CD that you want to program.**
Touch ▲ or ▼ to select the CD.
- 2 Touch A.MENU and FUNCTION and then touch NEXT.**
- 3 Touch ITS MEMORY.**
- 4 Touch ◀ or ▶ to select the desired track.**
- 5 Touch ▲ to store the currently playing track in the playlist.**
MEMORY is displayed briefly and the currently playing selection is added to your playlist. The display then shows track number again.



Note

After data for 100 discs has been stored in memory, data for a new disc will overwrite the oldest one.

Playback from your ITS playlist

ITS play lets you listen to the tracks that you have entered into your ITS playlist. When you turn on ITS play, tracks from your ITS playlist in the multi-CD player will begin to play.

- 1 Select the repeat range.**
Refer to *Repeating play* on the previous page.
- 2 Touch A.MENU and FUNCTION and then touch NEXT.**
- 3 Touch ITS PLAY.**
- 4 Touch ▲ to turn ITS play on.**
Playback begins of those tracks from your playlist within the previously selected **M-CD** or **DISC** ranges.
 - To turn ITS play off, touch ▼.

Erasing a track from your ITS playlist

When you want to delete a track from your ITS playlist, you can if ITS play is on.
If ITS play is already on, skip to step 2.

- 1 Play the CD with the track you want to delete from your ITS playlist, and turn ITS play on.**
Refer to *Playback from your ITS playlist* on this page.
- 2 Touch A.MENU and FUNCTION and then touch NEXT.**
- 3 Touch ITS MEMORY.**
- 4 Touch ◀ or ▶ to select the desired track.**

5 Touch ▼ to erase the track from your ITS playlist.

The currently playing selection is erased from your ITS playlist and playback of the next track from your ITS playlist begins.

- If there are no tracks from your playlist in the current range, **ITS EMPTY** is displayed and normal play resumes.

Erasing a CD from your ITS playlist

When you want to delete all tracks of a CD from your ITS playlist, you can if ITS play is off.

1 Play the CD that you want to delete.

Touch ▲ or ▼ to select the CD.

2 Touch A.MENU and FUNCTION and then touch NEXT.

3 Touch ITS MEMORY.

4 Touch ▼ to erase all tracks on the currently playing CD from your ITS playlist.

All tracks on the currently playing CD are erased from your playlist and **ALL CLEAR** is displayed. □

Using disc title functions

You can input CD titles and display the titles. Then you can easily search for and play a desired disc.

Entering disc titles

Use the disc title input feature to store up to 100 CD titles (with ITS playlist) into the multi-CD player. Each title can be up to 10 characters long.

- When playing a CD TEXT disc on a CD TEXT compatible multi-CD player, you cannot

switch to **TITLE EDIT**. The disc title will have already been recorded on a CD TEXT disc.

1 Play the CD that you want to enter a title for.

Touch ▲ or ▼ to select the CD.

2 Touch A.MENU and FUNCTION and then touch NEXT.

3 Touch TITLE EDIT.

4 Touch ABC to select the desired character type.

Touch **ABC** repeatedly to switch between the following character types:

Alphabet (upper case), numbers and symbols —Alphabet (lower case)—European letters, such as those with accents (e.g., á, à, ä, ç)

- You can select to input numbers and symbols by touching **123**.

5 Touch ▲ or ▼ to select a letter of the alphabet.

Each time you touch ▲ it will display a letter of the alphabet in **A B C ... X Y Z**, numbers and symbols in **1 2 3 ... } }** order. Each time you touch ▼ it will display a letter in the reverse order, such as **Z Y X ... C B A**.

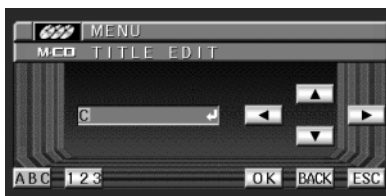

6 Touch ► to move the cursor to the next character position.

When the desired letter is displayed, touch ► to move the cursor to the next position and then select the next letter. Touch ◀ to move backwards in the display.

Multi-CD Player

7 Touch OK to store the entered title in memory.

8 Touch ESC to return to the playback display.



Notes

- Titles remain in memory, even after the disc has been removed from the magazine, and are recalled when the disc is reinserted.
- After data for 100 discs has been stored in memory, data for a new disc will overwrite the oldest one.

Displaying disc titles

You can display the title of any disc that has had a disc title entered.

● Touch DISP.

Touch **DISP** repeatedly to switch between the following settings:

DISC LIST (disc list)—**D.Title** (disc title)

When you select **D.Title**, the title of the currently playing disc is shown in the display.

- If no title has been entered for the currently playing disc, **NO TITLE** is displayed. 

Using CD TEXT functions

You can use these functions only with a CD TEXT compatible multi-CD player.

Some discs have certain information encoded on the disc during manufacture. These discs may contain such information as the CD title, track title, artist's name and playback time and are called CD TEXT discs. Only these specially encoded CD TEXT discs support the functions listed below.

Displaying titles on CD TEXT discs

● Touch DISP.

Touch **DISP** repeatedly to switch between the following settings:

DISC LIST (disc list)—**D.Title** (disc title)

—**D.Artist** (disc artist name)—**T.Title** (track title)—**T.Artist** (track artist name)

- If specific information has not been recorded on a CD TEXT disc, **NO XXXX** will be displayed (e.g., **NO ARTIST**).

Scrolling titles in the display

This unit can display the first 19 letters only of **D.Title**, **D.Artist**, **T.Title** and **T.Artist**. When the recorded information is longer than 19 letters, you can scroll the text to the left so that the rest of the title can be seen.

● Keep touching DISP until the title begins to scroll to the left.

The rest of the title will appear in the display.

Selecting tracks from the track title list

Track title list lets you see the list of track titles on a CD TEXT disc and select one of them to play back.

1 Touch A.MENU and FUNCTION and then touch TRACK LIST.

2 Touch PREV or NEXT to switch between the lists of titles.

3 Touch your favorite track title.

That selection will begin to play. 

Using compression and bass emphasis

You can use these functions only with a multi-CD player that supports them.

Using COMP (compression) and DBE (dynamic bass emphasis) functions lets you adjust the sound playback quality of the multi-CD player. Each of the functions has a two-step adjustment. The COMP function balances the output of louder and softer sounds at higher volumes. DBE boosts bass levels to give playback a fuller sound. Listen to each of the effects as you select them and use the one that best enhances the playback of the track or CD that you are listening to.

1 Touch **A.MENU** and **FUNCTION** and then touch **COMP**.

- If the multi-CD player does not support COMP/DBE, **NO COMP** is displayed when you attempt to select it.

2 Touch **◀▶** to select your favorite setting.

Touch **◀▶** repeatedly to switch between the following settings:

**COMP OFF—COMP 1—COMP 2—
COMP OFF—DBE 1—DBE 2**

- You can also select the desired setting by moving the joystick left or right. 

TV tuner

Watching the television

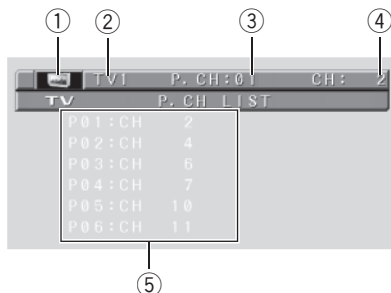

Only when using this unit with ADD-ON mode (M), you can perform the following operations by this unit.

You can use this unit to control a TV tuner, which is sold separately.

For details concerning operation, refer to the TV tuner's operation manuals. This section provides information on TV operations with this unit which differs from that described in the TV tuner's operation manual.

- ① **Source icon**
Shows which source has been selected.
- ② **Band indicator**
Shows which band the TV tuner is tuned to.
- ③ **Preset number indicator**
Shows which preset has been selected.
- ④ **Channel indicator**
Shows which channel the TV tuner is tuned.
- ⑤ **Preset list display**
Shows the preset list.

1 Touch the source icon and then touch TV to select the TV.

- When the source icon is not displayed, you can display it by touching the screen.

2 Touch the screen to display the touch panel keys.

3 Touch BAND to select a band.

Touch **BAND** repeatedly until the desired band is displayed, **TV1** or **TV2**.

4 To perform manual tuning, briefly touch ◀ or ▶.

The channels move up or down step by step.

- You can also perform manual tuning by moving the joystick left or right.

5 To perform seek tuning, keep touching ◀ or ▶ for about one second and release.

The tuner will scan the channels until a broadcast strong enough for good reception is found.

- You can cancel seek tuning by briefly touching either ◀ or ▶.
- If you keep touching ◀ or ▶ you can skip broadcasting channels. Seek tuning starts as soon as you release the keys.
- You can also perform seek tuning by holding the joystick left or right.

Note

If you do not use the touch panel keys within 30 seconds, they will be hidden automatically. 

Storing the strongest broadcast stations sequentially



① Function display

Shows the function names.

1 Touch **A.MENU** and **FUNCTION** and then touch **BSSM**.

- When **A.MENU** is not displayed, you can display it by touching the screen.
- You can also display **MENU** by clicking the joystick.

2 Touch **▲** to turn **BSSM** on.

BSSM begins to flash. While **BSSM** is flashing the 12 strongest broadcast stations will be stored in order from the lowest channel up. When finished, **BSSM** disappears.

- To cancel the storage process, touch **▼**.
- To return to the previous display, touch **BACK**.
- To return to the TV picture, touch **ESC**.

Notes

- Storing broadcast stations with **BSSM** may replace broadcast stations you have saved using **P01—P12**.
- If you do not operate the function within about 30 seconds, the display is automatically returned to the TV picture. 

Storing and recalling broadcast stations

If you touch any of the preset tuning keys **P01—P12** you can easily store up to 12 broadcast stations for later recall with the touch of a key.

● When you find a station that you want to store in memory, keep touching one of preset tuning keys **P01—P12** until the preset number stops flashing.

The number you have touched will flash in the preset number indicator and then remain lit. The selected station has been stored in memory.

The next time you touch the same preset tuning key the station is recalled from memory.

- To switch between **P01—P06** and **P07—P12**, touch **PREV** or **NEXT**.
- When the touch panel keys are not displayed, you can display them by touching the screen.
- When **P01—P06** and **P07—P12** are not displayed, you can display them by touching **DISP**.



Notes

- Up to 24 stations, 12 for each of two TV bands, can be stored in memory.
- You can also use **▲** and **▼** to recall stations assigned to preset tuning keys **P01—P12**. 

Setting up the DVD player

Introduction of DVD setup adjustments

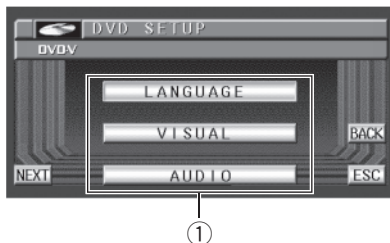

You can use this menu to change audio, subtitle, parental lock and other DVD settings.

- When watching a DVD/Video CD on the rear display independently, you cannot operate this menu.

① DVD setup menu display

Shows the DVD setup menu names.

1 Touch ■.

SETUP will be displayed instead of **MENU**.

2 Touch **SETUP** when the disc is stopped.

The DVD setup menu is displayed.

- When **SETUP** is not displayed, you can display it by touching the screen.
- You can also display **DVD SETUP** by pressing **MENU** on the remote control when the disc is stopped.

3 Touch any of **LANGUAGE**, **VISUAL**, **AUDIO** or **OTHERS** to display the DVD setup function names.

The DVD setup function names in selected menu are displayed.

- To display **OTHERS**, touch **NEXT** after touching **SETUP**.
- To go to the next group of function names, touch **NEXT**.
- To return to the previous group of function names, touch **PREV**.

- To return to the previous display, touch **BACK**.
- To return to the playback display, touch **ESC**.

Note

If you do not operate the DVD setup function within about 30 seconds, the display is automatically returned to the playback display. □

Setting the subtitle language

You can set a desired subtitle language. If the selected subtitle language is recorded on the DVD, subtitles are displayed in that language.

1 Touch **SETUP** and **LANGUAGE** and then touch **SUB.T LANG**.

A subtitle language menu is displayed and the currently set language is highlighted.

- To switch to the second language select menu, touch **NEXT**.
- To return to the first language select menu, touch **PREV**.

2 Touch the desired language.

A subtitle language is set.

- If you have selected **OTHERS**, refer to *When you select OTHERS on the next page*.

Notes

- If the selected language is not recorded on the disc, the language specified on the disc is displayed.
- You can also switch the subtitle language by touching **SUB.T** during playback. (Refer to *Changing the subtitle language during playback (Multi-subtitle)* on page 31.)
- Even if you use **SUB.T** to switch the subtitle language, this does not affect the settings here.

When you select OTHERS

When you select **OTHERS**, a language code input display is shown. Refer to *Language code chart for DVD* on page 79 to input the four-digit code of the desired language.

1 Touch 0—9 to input the language code.

- To cancel the inputted numbers, touch **C**.
- You can also input the desired number by using the joystick and **0-9**.

2 While the inputted number is displayed, touch ENTER.

Setting the audio language

You can set the preferred audio language.

1 Touch SETUP and LANGUAGE and then touch AUDIO LANG.

An audio language menu is displayed and the currently set language is highlighted.

- To switch to the second language select menu, touch **NEXT**.
- To return to the first language select menu, touch **PREV**.

2 Touch the desired language.

The audio language is set.

- If you have selected **OTHERS**, refer to *When you select OTHERS on this page*.



Notes

- If the selected language is not recorded on the disc, the language specified on the disc is outputted.
- You can also switch the audio language by touching **AUDIO** during playback. (Refer to *Changing audio language during playback (Multi-audio)* on page 31.)

- Even if you use **AUDIO** to switch the audio language, this does not affect the settings here. 

Setting the menu language

You can set the preferred language for displays of menus recorded on a disc.

1 Touch SETUP and LANGUAGE and then touch MENU LANG.

A menu language menu is displayed and the currently set language is highlighted.

- To switch to the second language select menu, touch **NEXT**.
- To return to the first language select menu, touch **PREV**.

2 Touch the desired language.

The menu language is set.

- If you have selected **OTHERS**, refer to *When you select OTHERS on this page*.



Note

If the selected language is not recorded on the disc, the language specified on the disc is displayed. 

Setting assist subtitles on or off

Assist subtitles offer explanations for the aurally impaired. However, they are only displayed if they are recorded on the DVD. You can turn assist subtitles on or off as desired.

1 Touch SETUP and LANGUAGE and then touch NEXT.

Setting up the DVD player

2 Touch A SUB TITL.

3 Touch ▲ to turn assist subtitles on.

- To turn assist subtitles off, touch ▼. 

Setting angle icon display

You can set it up so that the angle icon appears on scenes where the angle can be switched.

1 Touch SETUP and VISUAL and then touch M. ANGLE.

2 Touch ▲ to turn angle icon display on.

- To turn angle icon display off, touch ▼. 

Setting the aspect ratio

There are two kinds of display. A wide screen display has a width-to-height ratio (TV aspect) of 16:9, while a regular display has a TV aspect of 4:3. Be sure to select the correct TV aspect for the display connected to **REAR VIDEO OUTPUT**.

- When using a regular display, select either **LETTER BOX** or **PANSCAN**. Selecting **16:9** may result in an unnatural picture.
- If you select the TV aspect, the unit's display changes to the same setting.

1 Touch SETUP and VISUAL and then touch TV ASPECT.



2 Touch any of the following touch panel keys to select the TV aspect.

- **16:9** – Wide screen picture (16:9) is displayed as it is (initial setting)
- **LETTER BOX** – The picture is the shape of a letterbox with black bands at the top and bottom of the screen

- **PANSCAN** – The picture is cut short at the right and left of the screen



Notes

- When playing discs that do not specify **PANSCAN**, playback is with **LETTER BOX** even if you select **PANSCAN** setting. Confirm whether the disc package bears the  mark. (See page 12.)
- Some discs do not enable changing of the TV aspect. For details, refer to the disc's instructions. 

Setting the parental lock

Some DVD video discs let you use parental lock to restrict the viewing of violent and adult-oriented scenes by children. You can set the parental lock level in steps as desired.

- When you set a parental lock level and then play a disc featuring parental lock, code number input indications may be displayed. In this case, playback will begin when the correct code number is input.

Setting the code number and level

When you first use this function, register your code number. If you do not register a code number, parental lock will not operate.

1 Touch SETUP and VISUAL and then touch PARENTAL.

2 Touch 0—9 to input a four digit code number.

3 While the inputted number is displayed, touch ENTER.

The code number is set, and you can now set the level.

Setting up the DVD player

4 Touch any of 1—8 to select the desired level.

The parental lock level is set.

- **LEVEL 8** – Playback of the entire disc is possible (initial setting)
- **LEVEL 7–LEVEL 2** – Playback of discs for children and non-adult-oriented discs is possible
- **LEVEL 1** – Playback of discs for children only is possible



Notes

- We recommend to keep a record of your code number in case you forget it.
- The parental lock level is recorded on the disc. You can confirm it by looking at the disc package, included literature or on the disc itself. With discs that do not feature a recorded parental lock level, you cannot use parental lock.
- With some discs, parental lock operates to skip certain scenes only, after which normal playback resumes. For details, refer to the disc's instructions.

Changing the level

You can change the set parental lock level.

1 Touch **SETUP** and **VISUAL** and then touch **PARENTAL**.

2 Touch **0—9** to input the registered code number.

3 Touch **ENTER**.

This enters the code number, and you can now change the level.

- If you input an incorrect code number, the icon  is displayed. Touch **C** and input the correct code number.
- If you forget your code number, refer to *If you forget your code number* on this page.

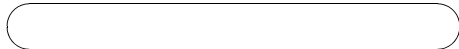

4 Touch any of 1—8 to select the desired level.

The new parental lock level is set.

If you forget your code number

Refer to *Changing the level* on this page, and touch **C** 10 times. The registered code number is canceled, letting you register a new one. 

Setting for digital output

Set digital output correctly to match the components you are using with this unit. There is no need to change settings if this unit is not connected for digital output.

- When using this unit with a Pioneer multi-channel processor (DEQ-P8000), select **DOLBY/LPCM**.
- When using this unit with a head unit features digital input (e.g., DEX-P9), select **LPCM**.



Important

Incorrect setting may result in noise and damage to speakers so be sure to read the manuals of the connected components.

1 Touch **SETUP** and **AUDIO** and then touch **DIGTL OUT**.

2 Touch either of the following touch panel keys to select the digital output setting.

- **DOLBY/LPCM** – The Dolby Digital signal is output as it is (initial setting)
- **LPCM** – The Dolby Digital signal is converted to and output as a linear PCM signal

Setting up the DVD player



Notes

- Linear PCM output of DTS audio is not possible. If you select **LPCM**, DTS audio is not output.
- When using an amplifier and decoder that are not Dolby Digital compatible, select **LPCM**.

Setting digital and analog audio output

You can set linear PCM audio output for both digital and analog output. Set audio output correctly to match the components you are using with this unit.

- When using digital connections, select **48kHz**.
- When using analog connections, select **96kHz**.



Important

If the setting is incorrect there will be no sound so be sure to read the manuals of the connected components.

1 Touch SETUP and AUDIO and then touch AUDIO OUT.

2 Touch either of the following touch panel keys to select the audio output setting.

- **48kHz** – A 48 kHz signal is output regardless of the audio sampling frequency. A 96 kHz signal is converted to a 48 kHz signal. (initial setting)
- **96kHz** – The signal is output with the same frequency as the audio sampling frequency. With a 96kHz signal, you can enjoy exceptionally high sound quality.



Notes

- With discs featuring 96 kHz recording, if you select **96kHz**, audio is not output from digital output.
- With discs that do not feature a CSS (Content Scrambling System) copy guard signal, a 96 kHz digital signal is output.
- When using this unit with a Pioneer multi-channel processor (DEQ-P8000), select **48kHz**. If you select **96kHz**, no sound will be output when playing discs featuring 96 kHz recordings.

Automatic playback of DVDs

When a DVD disc with DVD menu is inserted, this unit will cancel the DVD menu automatically and start playback from the first chapter of the first title.

- Some DVDs may not operate properly. If this function is not fully operated, turn this function off and start playback.

1 Touch SETUP and NEXT and then touch OTHERS.

2 Touch DVD A. PLAY.

3 Touch ▲ to turn automatic playback on.

- To turn automatic playback off, touch ▼.
- When the automatic playback is on, you cannot operate repeating play of DVD disc (refer to *Repeating play* on page 29).

Setting remote control code type

There are three remote control code types, code type **A**, code type **B** and code type **H/U**. Switch the remote code according to the combined components.

- **H/U** – Operating this unit with ADD-ON mode (**M**)
- **A** – Operating this unit with IP-BUS mode (**S**) when combined with a DVD navigation unit
- **B** – Operating this unit with IP-BUS mode (**S**) when combined with a multi-DVD player

1 Set the remote control selection switch on the left side of the remote control to the appropriate position with a pen tip or other pointed instrument .

- If you select **H/U** mode, there is no need to take the following procedure.
- If you select **A/B** mode, take the following procedure and change the code type to the appropriate type.

2 Press 7 and 0 on the remote control simultaneously to change the code type.

Initially, the code type is set to **A**. Each time you press **7** and **0** simultaneously on the remote control the code type switches between **A** and **B**.



Note

When the remote control operation switch is set to **DVD**, changing the remote control code type enables you to operate the Pioneer DVD player with the supplied remote control.

When operating the following components only which combined with this unit, be sure to select codes as follows:

- **A** – Operating a multi-DVD player
- **B** – Operating a DVD navigation unit (▣)

Initial Settings

Adjusting initial settings



Initial settings lets you perform initial setup of different settings for this unit.

① Function display

Shows the function names.

1 Press AV SOURCE and hold until the unit turns off.

2 Touch A.MENU and then touch INITIAL to display the function names.

The function names are displayed and operable ones are highlighted.

- When **A.MENU** is not displayed, you can display it by touching the screen.
- You can also display **MENU** by clicking the joystick.
- To return to the previous display, touch **BACK**.
- To return to the display of each source, touch **ESC**. 

Switching the warning tone

If the front panel is not detached from this unit within five seconds of turning off the ignition, a warning tone will sound. You can turn off the warning tone.

- Only when using this unit with ADD-ON mode (**M**), you can operate this function.

1 Touch A.MENU and INITIAL and then touch DT. WARNING.

2 Touch ▲ to turn warning tone on.

- To turn warning tone off, touch ▼. 

Switching the auxiliary setting

It is possible to use auxiliary equipment with this unit. Activate the auxiliary setting when using auxiliary equipment connected to this unit.

- Only when using this unit with ADD-ON mode (**M**), you can operate this function.

1 Touch A.MENU and INITIAL and then touch AUX.

2 Touch ▲ to turn auxiliary setting on.

- To turn auxiliary setting off, touch ▼. 

Switching the automatic disc playback

You can turn automatic disc playback on or off when you insert a disc into the disc loading slot. When this function is on, the disc will be automatically played after it is inserted into the disc loading slot.

Initially, this function is set to on.

1 Touch A.MENU and INITIAL and then touch DVD D. AUTO.

2 Touch ▲ to turn automatic disc playback on.

- To turn automatic disc playback off, touch ▼. 

Switching the wired remote control setting

When using this unit with a Pioneer head unit featuring jack for the wired remote control, you can operate the basic function of each source by touch panel key.

- Only when using this unit with IP-BUS mode (**S**), you can operate this function.

1 Touch A.MENU and INITIAL and then touch WIRED RMT.

2 Touch ▲ to turn wired remote control on.

- To turn wired remote control off, touch ▼. 

2 Touch ▲ or ▼ to select the remote control code type.

Touch ▲ to select **CODE A**. Touch ▼ to select **CODE B**. 

Selecting remote control code type

When using this unit with a Pioneer DVD player, changing the remote control code type enables you to operate this unit only. Select the appropriate remote code according to the combined components.

- Only when using this unit with IP-BUS mode (**S**), you can operate this function.
- Select **CODE A** when combined with a DVD navigation unit.
- Select **CODE B** when combined with a multi-DVD player.

Important

When changing the remote control code type, switch the remote control selection switch on the left side of the remote control to the appropriate position. (Refer to page 62.)

1 Touch A.MENU and INITIAL and then touch REM CODE.

Introduction of setup adjustments

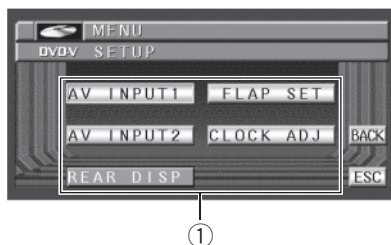

① Setup menu display

Shows the setup function names.

● Touch A.MENU and then touch SETUP to display the setup function names.

The setup function names are displayed and operable ones are highlighted.

- When **A.MENU** is not displayed, you can display it by touching the screen.
- You can also display **MENU** by clicking the joystick.
- To return to the previous display, touch **BACK**.
- To return to the display of each source, touch **ESC**.



Note

If you do not operate the setup function within about 30 seconds, the display is automatically returned to the source display. 

Setting the video input 1

You can switch the setting according to the connected component.

- Select **VIDEO** to watch video of a connected component as **AV-1** source.
- Select **DVD** to watch video of a connected Pioneer DVD head unit.

1 Touch **A.MENU** and **SETUP** and then touch **AV INPUT1**.

2 Touch **◀** or **▶** to select the video input 1 setting.

Touch **◀** or **▶** until the desired setting appears in the display.

- **OFF** – No video component is connected
- **VIDEO** – External video component
- **DVD** – Pioneer DVD head unit (e.g., DVH-P5000MP)
- Only when using this unit with IP-BUS mode **(S)**, you can select **DVD**. 

Setting the video input 2

You can switch the setting according to the connected component.

- Select **VIDEO** to watch video of a connected component as **AV-2** source.
- Select **B. CAMERA** when a rear view camera is installed on your vehicle.

1 Touch **A.MENU** and **SETUP** and then touch **AV INPUT2**.

2 Touch **◀** or **▶** to select the video input 2 setting.

Touch **◀** or **▶** until the desired setting appears in the display.

- **OFF** – No video component is connected
- **VIDEO** – External video component
- **B. CAMERA** – Rear view camera

Setting for rear view camera



CAUTION

Pioneer recommends the use of a camera which outputs mirror reversed images, otherwise screen image may appear reversed.

This unit features a function that automatically switches to the rear view camera video (**VIDEO 2/BACK CAMERA INPUT** jack) when a rear view camera is installed on your vehicle. When the gear shift is in **REVERSE (R)** position, the video automatically switches to a rear view camera video. (For more details, consult your dealer.)

- Confirm the setting immediately whether the display changes to a rear view camera video when the gear shift is moved to **REVERSE (R)** from another position.
- When the display changes to a rear view camera video during normal drivings, switch to another setting.
- To return to the source display, press **V.ADJ.**

1 Touch A.MENU and SETUP and then touch AV INPUT2.

2 Touch ◀ or ▶ to select B. CAMERA.

3 Touch ▼ to select POLARITY.

4 Touch ◀ or ▶ to select an appropriate setting for polarity.

Each time you touch ◀ or ▶ it switches between the following polarity:

- **BATTERY** – When the polarity of the connected lead is positive while the gear shift is in **REVERSE (R)** position
- **GND** – When the polarity of the connected lead is negative while the gear shift is in **REVERSE (R)** position 

Selecting the video of rear display

When the navigation image is displayed on front display, you can select either showing the navigation image on rear display or a video of a selected source.

- Only when a Pioneer navigation unit is connected to this unit, you can switch the video of rear display.
- When selecting **SOURCE** in **REAR DISP.**, when the selected source is an audio source, nothing is displayed on rear display.

1 Touch A.MENU and SETUP and then touch REAR DISP.

2 Touch ◀ or ▶ to select the video on rear display.

Touch ◀ or ▶ until the desired video setting appears in the display.

- **SOURCE** – Display the video of the selected source on rear display
- **NAVI** – Display the navigation image on rear display 

Setting the automatic open function

To prevent the display from hitting the shift lever of an automatic vehicle when it is in **P** (park) position, or when you do not wish the display to open/close automatically, you can set the automatic open function in the manual mode.

Furthermore, to adjust the LCD panel slide position, you can turn the set back on or off.

1 Touch A.MENU and SETUP and then touch FLAP SET.

2 Touch ▲ and the LCD panel slides to the back.

- Touch ▼ and the LCD panel slides to the front.

3 Touch ◀ or ▶ to select the display to open/close automatically or manually.

Touch ◀ to select **MANUAL**, and you have to press **OPEN/CLOSE** to open/close the display.

Other Functions

Touch **▶** to select **AUTO**, and the display automatically opens/closes when power to this unit is turned on. 

Setting the clock

Use these instructions to set the clock.

1 Touch A.MENU and SETUP and then touch CLOCK ADJ.

2 Touch OFF to turn the clock display on. **ON** will appear in the display instead of **OFF**. Clock display is now on.

▪ To turn the clock display off, touch **ON**.

3 Touch ◀ or ▶ to select the segment of the clock display you wish to set.

Each time you touch **◀** or **▶** it will select one segment of the clock display:

Hour—Minute

As you select segments of the clock display the segment selected will be highlighted.



4 Touch ▲ or ▼ to set the clock.

Each time you touch **▲** it increases the selected hour or minute. Each time you touch **▼** it decreases the selected hour or minute.

Notes

- You can match the clock to a time signal by touching **JUST**.
 - If the minute is **00—29**, the minutes are rounded down. (e.g., **10:18** becomes **10:00**.)

— If the minute is **30—59**, the minutes are rounded up. (e.g., **10:36** becomes **11:00**.)

- Even when the sources are off, the clock display appears on the display. 

Using the AUX source

An IP-BUS-RCA Interconnector such as the CD-RB20/CD-RB10 (sold separately) lets you connect this unit to auxiliary equipment featuring RCA output. For more details, refer to the IP-BUS-RCA Interconnector owner's manual.

- Only when using this unit with ADD-ON mode (**M**), you can use the AUX source.

Selecting AUX as the source

● **Touch the source icon and then touch AUX to select AUX as the source.**

- When the source icon is not displayed, you can display it by touching the screen.
- If the auxiliary setting is not turned on, **AUX** cannot be selected. For more details, see *Switching the auxiliary setting* on page 63.

Setting the AUX title

The title displayed for the **AUX** source can be changed.

1 After you have selected AUX as the source, touch A.MENU and FUNCTION and then touch NAME EDIT.

2 Touch ABC to select the desired character type.

Touch **ABC** repeatedly to switch between the following character types:
 Alphabet (upper case), numbers and symbols
 —Alphabet (lower case)—European letters, such as those with accents (e.g., **á, à, ä, ç**)

- You can select to input numbers and symbols by touching **123**.

3 Touch ▲ or ▼ to select a letter of the alphabet.

Each time you touch ▲ it will display a letter of the alphabet in **A B C ... X Y Z**, numbers and symbols in **1 2 3 ... |}** order. Each time you touch ▼ it will display a letter in the reverse order, such as **Z Y X ... C B A**.



4 Touch ► to move the cursor to the next character position.

When the desired letter is displayed, touch ► to move the cursor to the next position and then select the next letter. Touch ◀ to move backwards in the display.

5 Touch OK to store the entered title in memory.

6 Touch ESC to return to the playback display. ◻

Switching the background display

You can switch background displays while listening to each source.

- In the following cases, the background display will not change:
 - When **AV INPUT1** (video input 1) and/or **AV INPUT2** (video input 2) are not set to **VIDEO** (refer to page 65).

- When the DVD/Video CD playback is not turned on for rear display (refer to page 20).
 - When a Pioneer navigation unit is not connected to this unit.
- Dolphin movie will not appear when the touch panel keys or the list is displayed.

IP-BUS mode (S)

● Press ENTERTAINMENT.

Each time you press **ENTERTAINMENT** the display changes in the following order:
 Video of currently selected source—**DOLPHIN** (background visual)—**AV-1** (video input 1)
 —**AV-2** (video input 2)—**DVD** (DVD player)
 —**NAVI** (navigation unit wallpaper)

- When this player which is turned off is selected as a source, you cannot use **ENTERTAINMENT**.



Note

When the selected source is an audio source, when you select the video of currently selected source, nothing is displayed on the display.

ADD-ON mode (M)

● Press ENTERTAINMENT.

Each time you press **ENTERTAINMENT** the display changes in the following order:

Audio source

Background still picture—**BGV** (background visual)—**AV-1** (video input 1)—**AV-2** (video input 2)—**DVD** (DVD player)—**NAVI** (navigation unit wallpaper)

Video source

Video of currently selected source—background still picture—**BGV** (background visual)—**AV-1** (video input 1)—**AV-2** (video input 2)
 —**DVD** (DVD player)—**NAVI** (navigation unit wallpaper) ◻

Other Functions

Using the PGM button

You can operate the preprogrammed functions for each source by using

BOOKMARK (BOOK.M).

- Only when using this unit with ADD-ON mode (M), you can operate this function.

- **Press BOOKMARK (BOOK.M) to turn pause on when selecting the following sources:**

- Built-in DVD player
- Multi-CD Player

- To turn pause off, press

BOOKMARK (BOOK.M) again.

- **Press BOOKMARK (BOOK.M) and hold to turn BSSM on when selecting television as the source.**

Press **BOOKMARK (BOOK.M)** and hold until the BSSM turns on.

- To cancel the storage process, press

BOOKMARK (BOOK.M) again.

When combined with a Pioneer head unit

Operating each source by touch panel key

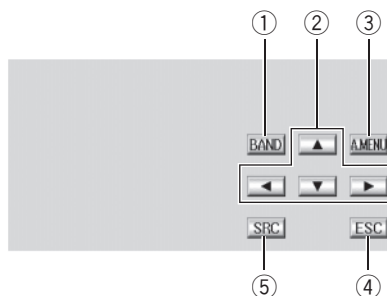

When using this unit with a Pioneer head unit featuring jack for the wired remote control, you can operate the basic function of each source by touch panel key.

- You can use the touch panel keys only when turned wired remote control on. (Refer to *Switching the wired remote control setting* on page 64.)

① **BAND key**

Touch to select among three FM bands and one AM band and to cancel the control mode of functions.

② **▲/▼/◀/▶ keys**

Touch to do manual seek tuning, fast forward, reverse and track search controls. Also used for controlling functions.

③ **A.MENU key**

Touch to display **MENU** only for this unit.

④ **ESC key**

Touch to hide the touch panel keys.

⑤ SRC key

This unit is turned on by selecting a source. Touch to cycle through all the available sources. 

Introduction of DVD operation

You can use this unit with a separately sold DVD player or multi-DVD player.

For details concerning operation, refer to the DVD player's or multi-DVD player's operation manual. This section provides information on DVD operations with this unit which differs from that described in the DVD player's or multi-DVD player's operation manual.

- Only the remote control can operate the following functions. To perform the following functions, switch the remote control operation mode to **DVD**. (Refer to page 17.)

Turning the DVD player on or off

- **Press REAR.S to turn the DVD player on.**
 - To turn the DVD player off, press **REAR.S** again.

Selecting a disc

- You can operate this function only when a multi-DVD player is connected to this unit.
- **Press BACK or ENTERTAINMENT to select a disc.** 

Additional Information

Troubleshooting

Common

Symptom	Cause	Action (See)
Power doesn't turn on. The unit doesn't operate.	Leads and connectors are incorrectly connected.	Confirm once more that all connections are correct.
	The fuse is blown.	Rectify the reason for the fuse blowing, then replace the fuse. Be very sure to install the correct fuse with the same rating.
	Noise and other factors are causing the built-in microprocessor to operate incorrectly.	Press RESET . (Page 12)
Operation with the remote control isn't possible. The unit does not operate correctly even when the appropriate remote control buttons are pressed.	The remote control operation mode is incorrect.	Switch to the correct remote control mode. (Page 17)
	The remote control code is incorrect.	Make sure the remote control selection switch setting and code type setting are the same. (Page 62, Page 64)
	Battery power is low.	Load new battery. (Page 13)
	Some operations are prohibited with certain discs.	Check by using another disc.
Playback is not possible.	The disc is dirty.	Clean disc. (Page 74)
	The loaded disc is a type this unit cannot play.	Check what type the disc is.
	Non compatible video system disc is loaded.	Change to a disc compatible to your video system.
No sounds are heard. The volume level will not rise.	Cables are not connected correctly.	Connect the cables correctly.
	With some discs, 96 kHz output is prohibited.	Switch the output setting to 48 kHz. (Page 61)
	The unit is performing still, slow motion or frame-by-frame playback.	There is no sound during still, slow motion or frame-by-frame playback.
There is no picture.	The parking brake cord is not connected.	Connect a parking brake cord, and apply the parking brake.
	The parking brake is not applied.	Connect a parking brake cord, and apply the parking brake.
The icon  is displayed, and operation is not possible.	The operation is prohibited for the disc.	This operation is not possible.
	The operation is not compatible with the disc's organization.	This operation is not possible.
The picture stops (pauses) and the unit cannot be operated.	Reading of data has become impossible during playback.	After pressing ■ once, start playback once more.
There is no sound. Volume level is low.	The volume level is low.	Adjust the volume level.
	The attenuator is on.	Turn the attenuator off.
There is audio and video skipping.	The unit is not firmly secured.	Secure the unit firmly.

Additional Information

Symptom	Cause	Action (See)
The picture is stretched, the aspect is incorrect.	The aspect setting is incorrect for the display.	Select the appropriate setting for your display. (Page 59)
When the ignition switch is turned ON (or turned to ACC), the motor sounds.	The unit is confirming whether a disc is loaded or not.	This is a normal operation.
Nothing is displayed. The touch panel keys cannot be used.	The rear view camera is not connected. B. CAMERA is at incorrect setting.	Connect a rear view camera. Press V.ADJ to return to the source display and then select the correct setting for B. CAMERA . (Page 65)

Problems during DVD playback

Symptom	Cause	Action (See)
Playback is not possible.	The loaded disc has a different region number from this unit.	Replace the disc with one featuring the same region number as this unit. (Page 8, Page 81)
A parental lock message is displayed and playback is not possible.	Parental lock is on.	Turn parental lock off or change the level. (Page 59)
Parental lock cannot be canceled.	The code number is incorrect.	Input the correct code number. (Page 59)
	You have forgotten your code number.	Press CLEAR 10 times to cancel the code number. (Page 60)
Dialog language (and subtitle language) cannot be switched.	The DVD playing does not feature multiple language recordings.	You cannot switch among multiple languages if they are not recorded on the disc.
	You can only switch between items indicated in the disc menu.	Switch using the disc menu.
No subtitles are displayed.	The DVD playing does not feature subtitles.	Subtitles are not displayed if they are not recorded on the disc.
	You can only switch between items indicated in the disc menu.	Switch using the disc menu.
Playback is not with the audio language and subtitle language settings selected in DVD SETUP .	The DVD playing does not feature dialog or subtitles in the language selected in DVD SETUP .	Switching to a selected language is not possible if the language selected in DVD SETUP is not recorded on the disc.
Switching the viewing angle is not possible.	The DVD playing does not feature scenes shot from multiple angles.	You cannot switch between multiple angles if the DVD does not feature scenes recorded from multiple angles.
	You are trying to switch to multiple angle viewing of a scene that is not recorded from multiple angles.	Switch between multiple angles when watching scenes recorded from multiple angles.
The picture is extremely unclear/distorted and dark during playback.	The disc features a signal to prohibit copying. (Some discs may have this.)	Since this unit is compatible with the copy guard analog copy protect system, when playing a disc that has a signal prohibiting copying, the picture may suffer from horizontal stripes or other imperfections when viewed on some displays. This does not mean this unit is malfunctioning.

Additional Information

Problems during Video CD playback

Symptom	Cause	Action (See)
The PBC (playback control) menu display cannot be called up.	The Video CD playing does not feature PBC.	This operation is not possible with Video CDs not featuring PBC.
Repeat play and track/time search are not possible.	The Video CD playing features PBC.	This operation is not possible with Video CDs featuring PBC.

Problems during multi-channel processor connection

Symptom	Cause	Action (See)
No sounds are heard. The volume level will not rise.	Optical cables are not connected correctly.	Connect the cables correctly.
	Multi-channel processor is not compatible with a 96 kHz signal.	Switch the output setting to 48 kHz. (Page 61)



Error messages

When problems occur with disc playback, an error message appears on the display. Refer to the table below to identify the problem, then take the suggested corrective action. If the error persists, contact your dealer or your nearest PIONEER Service Center.

Message	Cause	Action (See)
ERROR-02	Dirty disc	Clean disc.
	Scratched disc	Replace disc.
	The disc is loaded upside down	Check that the disc is loaded correctly.
ERROR-05	Electrical or mechanical	Press RESET .
DIFFERENT REGION DISC	The disc does not have the same region number as this unit	Replace the DVD video with one bearing the correct region number.
NON PLAYABLE DISC	This type of disc cannot be played by this unit	Replace the disc with one this unit can play.
THERMAL PROTECTION IN MOTION	The temperature of this unit is outside the normal operating range	Wait until the unit's temperature returns to within normal operating limits.
PROTECT	All the files on the inserted disc are secured by digital rights management (DRM)	Replace disc.
TRK SKIPPED	The inserted disc contains WMA files that are protected by digital rights management (DRM)	Replace disc.



Additional Information

DVD player and care

- Use only normal, round discs. If you insert irregular, non-round, shaped discs they may jam in the DVD player or not play properly.

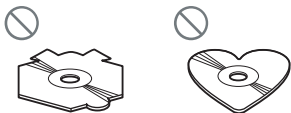

- Check all discs for cracks, scratches or warping before playing. Discs that have cracks, scratches or are warped may not play properly. Do not use such discs.
- Avoid touching the recorded (non-printed) surface when handling the disc.
- Store discs in their cases when not in use.
- Keep discs out of direct sunlight and do not expose the discs to high temperatures.
- Do not attach labels, write on or apply chemicals to the surface of the discs.
- To clean a disc, wipe the disc with a soft cloth outward from the center.



- If the heater is used in cold weather, condensation may form on components inside the DVD player. Condensation may cause the DVD player to not operate properly. If you think that condensation is a problem turn off the DVD player for an hour or so to allow it to dry out and wipe any damp discs with a soft cloth to remove the moisture.
- Road shocks may interrupt disc playback. ▣

DVD discs

- With some DVD video discs, it may not be possible to use certain functions.
- It may not be possible to play back some DVD video discs.
- When DVD-R/DVD-RW discs are used, playback is possible only for discs which have been finalized.
- When DVD-R/DVD-RW discs are used, playback is possible only for discs which have been recorded with the Video format (video mode). It is not possible to play back DVD-RW discs which have been recorded with the Video Recording format (VR mode).
- It may not be possible to play back DVD-R/DVD-RW discs which have been recorded with the Video format (video mode), because of disc characteristics, scratches or dirt on the disc, or dirt, condensation, etc. on the lens of this unit.
- It is not possible to play back DVD-ROM/DVD-RAM discs.
- Playback of discs recorded on a personal computer may not be possible, depending on the application settings and the environment. Please record with the correct format. (For details, contact the manufacturer of the application.) ▣

CD-R/CD-RW discs

- When CD-R/CD-RW discs are used, playback is possible only for discs which have been finalized.
- It may not be possible to play back CD-R/CD-RW discs recorded on a music CD recorder or a personal computer because of disc characteristics, scratches or dirt on the disc, or dirt, condensation, etc., on the lens of this unit.
- Playback of discs recorded on a personal computer may not be possible, depending

Additional Information

on the application settings and the environment. Please record with the correct format. (For details, contact the manufacturer of the application.)

- Playback of CD-R/CD-RW discs may become impossible in case of direct exposure to sunlight, high temperatures, or the storage conditions in the vehicle.
- Titles and other text information recorded on a CD-R/CD-RW disc may not be displayed by this unit (in the case of audio data (CD-DA)).
- This unit conforms to the track skip function of the CD-R/CD-RW disc. The tracks containing the track skip information are skipped automatically (in case of audio data (CD-DA)).
- If you insert a CD-RW disc into this unit, time to playback will be longer than when you insert a conventional CD or CD-R disc.
- Read the precautions with CD-R/CD-RW discs before using them. 

MP3 and WMA files

- MP3 is short for MPEG Audio Layer 3 and refers to an audio compression technology standard.
- WMA is short for Windows Media™ Audio and refers to an audio compression technology that is developed by Microsoft Corporation. WMA data can be encoded by using Windows Media Player version 7 or later.
- With some applications used to encode WMA files, this unit may not operate correctly.
- With some applications used to encode WMA files, album names and other text information may not be correctly displayed.
- This unit allows playback of MP3/WMA files on CD-ROM, CD-R and CD-RW discs. Disc recordings compatible with level 1

and level 2 of ISO9660 and with the Romeo and Joliet file system can be played back.

- It is possible to play back multi-session compatible recorded discs.
- MP3/WMA files are not compatible with packet write data transfer.
- The maximum number of characters which can be displayed for a file name, including the extension (.mp3 or .wma), is 64, from the first character.
- The maximum number of characters which can be displayed for a folder name is 64.
- In case of files recorded according to the Romeo file system, only the first 64 characters can be displayed.
- When playing discs with MP3/WMA files and audio data (CD-DA) such as CD-EXTRA and MIXED-MODE CDs, both types can be played only by switching mode between MP3/WMA and CD-DA.
- The folder selection sequence for playback and other operations becomes the writing sequence used by the writing software. For this reason, the expected sequence at the time of playback may not coincide with the actual playback sequence. However, there also is some writing software which permits setting of the playback order.
- Some audio CDs contain tracks that merge into one another without a pause. When these discs are converted to MP3/WMA files and burned to a CD-R/CD-RW/CD-ROM, the files will be played back on this player with a short pause between each one, regardless of the length of the pause between tracks on the original audio CD.



Important

- When naming an MP3 or a WMA file, add the corresponding filename extension (.mp3 or .wma).

Additional Information

- This unit plays back files with the filename extension (.mp3 or .wma) as an MP3 or a WMA file. To prevent noise and malfunctions, do not use these extensions for files other than MP3 or WMA files.

MP3 additional information

- Files are compatible with the ID3 Tag Ver. 1.0, 1.1, 2.2, 2.3 and 2.4 formats for display of album (disc title), track (track title), artist (track artist) and comments. Ver. 2.x of ID3 Tag is given priority when both Ver. 1.x and Ver. 2.x exist.
- The emphasis function is valid only when MP3 files of 32, 44.1 and 48 kHz frequencies are played back. (16, 22.05, 24, 32, 44.1, 48 kHz sampling frequencies can be played back.)
- There is no m3u playlist compatibility.
- There is no compatibility with the MP3i (MP3 interactive) or mp3 PRO formats.
- The sound quality of MP3 files generally becomes better with an increased bit rate. This unit can play recordings with bit rates from 8 kbps to 320 kbps, but in order to be able to enjoy sound of a certain quality, we recommend using only discs recorded with a bit rate of at least 128 kbps.

WMA additional information

- This unit plays back WMA files encoded by Windows Media Player version 7 and 8.
- You can only play back WMA files in the frequencies 32, 44.1 and 48 kHz.
- The sound quality of WMA files generally becomes better with an increased bit rate. This unit can play recordings with bit rates from 48 kbps to 192 kbps, but in order to be able to enjoy sound of a certain quality, we recommend using discs recorded with a higher bit rate.

- This unit does not play back WMA files recorded as VBR (variable bit rate).

About folders and MP3/WMA files

- An outline of a CD-ROM with MP3/WMA files on it is shown below. Subfolders are shown as folders in the folder currently selected.

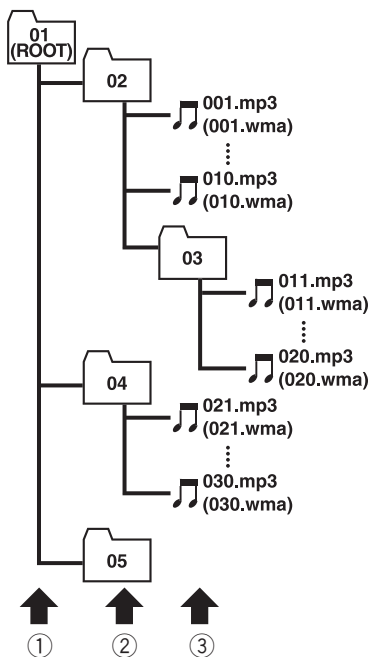

- ① First level
- ② Second level
- ③ Third level

Additional Information



Notes

- This unit assigns folder numbers. The user can not assign folder numbers.
- It is not possible to check folders that do not include MP3/WMA files. (These folders will be skipped without displaying the folder number.)
- MP3/WMA files in up to 8 tiers of folders can be played back. However, there is a delay in the start of playback on discs with numerous tiers. For this reason we recommend creating discs with no more than 2 tiers.
- It is possible to play back up to 253 items from folders on one disc. □

Using the display correctly



CAUTION

- If liquid or foreign matter should get inside this unit, turn off the power immediately and consult your dealer or the nearest authorized PIONEER Service Station. Do not use the unit in this condition because doing so may result in a fire, electric shock, or other failure.
- If you notice smoke, a strange noise or smell, or any other abnormal signs from the display, turn off the power immediately and consult your dealer or the nearest authorized PIONEER Service Station. Using this unit in this condition may result in permanent damage to the system.
- Do not disassemble or modify this unit, as there are high-voltage components inside which may cause an electric shock. Be sure to consult your dealer or the nearest authorized PIONEER Service Station for internal inspection, adjustments or repairs.

Handling the display

- When the display is subjected to direct sunlight for a long period of time, it will become very hot resulting in possible

damage to the LCD screen. When not using this unit, close the display and avoid exposing it to direct sunlight.

- The display should be used within the temperature ranges shown below.
Operating temperature range: +14 to +122 °F
Storage temperature range: -4 to +176 °F
At temperatures higher or lower than the operating temperature range the display may not operate normally.
- The LCD screen of this unit is exposed in order to increase its visibility within the vehicle. Please do not press strongly on it as this may damage it.
- Do not place anything on the display when it is opened. Also, do not attempt to carry out angle adjustment, or open/close the display by hand. Applying strong force to the display may damage it.
- Do not push the LCD screen with much force as this may scratch it.
- Be careful not to place anything between the display and the main body when the display is opening or closing. If an object gets between the display and main body, the display may stop working.
- Be careful of fingers, long hair, and loose articles of clothing which could possibly get caught between the display and the main body and cause serious injury.

Liquid crystal display (LCD) screen

- If the display is near the vent of an air conditioner when it is opened, make sure that air from the air conditioner is not blowing on it. Heat from the heater may damage the LCD screen, and cool air from the cooler may cause moisture to form inside the display resulting in possible damage. Also, if the display is cooled down by the cooler, the screen may become dark, or the life span of the small fluorescent tube used inside the display may be shortened.

Additional Information

- Small black dots or white dots (bright dots) may appear on the LCD screen. These are due to the characteristics of the LCD screen and do not indicate a problem with the display.
- At low temperatures, the LCD screen may be dark for a while after the power is turned on.
- The LCD screen will be difficult to see if it is exposed to direct sunlight.
- When using a portable phone, keep the antenna of the portable phone away from the display to prevent disruption of the video by the appearance of spots, colored stripes, etc.

Keeping the display in good condition

- When removing dust from the screen or cleaning the display, first turn the system power off, then wipe with the **supplied cloth**.
- When wiping the screen, take care not to scratch the surface. Do not use harsh or abrasive chemical cleaners.

Small fluorescent tube

- A small fluorescent tube is used inside the display to illuminate the LCD screen.
 - The fluorescent tube should last for approximately 10,000 hours, depending on operating conditions. (Using the display at low temperatures reduces the service life of the fluorescent tube.)
 - When the fluorescent tube reaches the end of its useful life, the screen will be dark and the image will no longer be projected. If this happens, consult your dealer or the nearest authorized PIO-NEER Service Station. ▣

Additional Information

Language code chart for DVD

Language (code), input code	Language (code), input code	Language (code), input code
Japanese (ja), 1001	Guarani (gn), 0714	Pashto, Pushto (ps), 1619
English (en), 0514	Gujarati (gu), 0721	Quechua (qu), 1721
French (fr), 0618	Hausa (ha), 0801	Rhaeto-Romance (rm), 1813
Spanish (es), 0519	Hindi (hi), 0809	Kirundi (rn), 1814
German (de), 0405	Croatian (hr), 0818	Romanian (ro), 1815
Italian (it), 0920	Hungarian (hu), 0821	Kinyarwanda (rw), 1823
Chinese (zh), 2608	Armenian (hy), 0825	Sanskrit (sa), 1901
Dutch (nl), 1412	Interlingua (ia), 0901	Sindhi (sd), 1904
Portuguese (pt), 1620	Interlingue (ie), 0905	Sangho (sg), 1907
Swedish (sv), 1922	Inupiak (ik), 0911	Serbo-Croatian (sh), 1908
Russian (ru), 1821	Indonesian (in), 0914	Sinhalese (si), 1909
Korean (ko), 1115	Icelandic (is), 0919	Slovak (sk), 1911
Greek (el), 0512	Hebrew (iw), 0923	Slovenian (sl), 1912
Afar (aa), 0101	Yiddish (ji), 1009	Samoan (sm), 1913
Abkhazian (ab), 0102	Javanese (jw), 1023	Shona (sn), 1914
Afrikaans (af), 0106	Georgian (ka), 1101	Somali (so), 1915
Amharic (am), 0113	Kazakh (kk), 1111	Albanian (sq), 1917
Arabic (ar), 0118	Greenlandic (kl), 1112	Serbian (sr), 1918
Assamese (as), 0119	Cambodian (km), 1113	Siswati (ss), 1919
Aymara (ay), 0125	Kannada (kn), 1114	Sesotho (st), 1920
Azerbaijani (az), 0126	Kashmiri (ks), 1119	Sundanese (su), 1921
Bashkir (ba), 0201	Kurdish (ku), 1121	Swahili (sw), 1923
Byelorussian (be), 0205	Kirghiz (ky), 1125	Tamil (ta), 2001
Bulgarian (bg), 0207	Latin (la), 1201	Telugu (te), 2005
Bihari (bh), 0208	Lingala (ln), 1214	Tajik (tg), 2007
Bislama (bi), 0209	Laothian (lo), 1215	Thai (th), 2008
Bengali (bn), 0214	Lithuanian (lt), 1220	Tigrinya (ti), 2009
Tibetan (bo), 0215	Latvian (lv), 1222	Turkmen (tk), 2011
Breton (br), 0218	Malagasy (mg), 1307	Tagalog (tl), 2012
Catalan (ca), 0301	Maori (mi), 1309	Setswana (tn), 2014
Corsican (co), 0315	Macedonian (mk), 1311	Tonga (to), 2015
Czech (cs), 0319	Malayalam (ml), 1312	Turkish (tr), 2018
Welsh (cy), 0325	Mongolian (mn), 1314	Tsonga (ts), 2019
Danish (da), 0401	Moldavian (mo), 1315	Tatar (tt), 2020
Bhutani (dz), 0426	Marathi (mr), 1318	Twi (tw), 2023
Esperanto (eo), 0515	Malay (ms), 1319	Ukrainian (uk), 2111
Estonian (et), 0520	Maltese (mt), 1320	Urdu (ur), 2118
Basque (eu), 0521	Burmese (my), 1325	Uzbek (uz), 2126
Persian (fa), 0601	Nauru (na), 1401	Vietnamese (vi), 2209
Finnish (fi), 0609	Nepali (ne), 1405	Volapük (vo), 2215
Fiji (fj), 0610	Norwegian (no), 1415	Wolof (wo), 2315
Faroese (fo), 0615	Occitan (oc), 1503	Xhosa (xh), 2408
Frisian (fy), 0625	Oromo (om), 1513	Yoruba (yo), 2515
Irish (ga), 0701	Oriya (or), 1518	Zulu (zu), 2621
Scots-Gaelic (gd), 0704	Punjabi (pa), 1601	
Galician (gl), 0712	Polish (pl), 1612	



Additional Information

Terms

Aspect ratio

This is the width-to-height ratio of a TV screen. A regular display has an aspect ratio of 4:3. Wide screen displays have an aspect ratio of 16:9, providing a bigger picture for exceptional presence and atmosphere.

Bit rate

This expresses data volume per second, or bps units (bits per second). The higher the rate, the more information is available to reproduce the sound. Using the same encoding method (such as MP3), the higher the rate, the better the sound.

Chapter

DVD titles are in turn divided into chapters which are numbered in the same way as the chapters of a book. With DVD video discs featuring chapters, you can quickly find a desired scene with chapter search.

Dolby Digital

Dolby Digital provides multi-channel audio from up to 5.1 independent channels. This is the same as the Dolby Digital surround sound system used in theaters.



DTS

This stands for Digital Theater Systems. DTS is a surround system delivering multi-channel audio from up to 6 independent channels.



ID3 tag

This is a method of embedding track-related information in an MP3 file. This embedded information can include the track title, the artist's name, the album title, the music genre,

the year of production, comments and other data. The contents can be freely edited using software with ID3 Tag editing functions. Although the tags are restricted as to the number of characters, the information can be viewed when the track is played back.

ISO9660 format

This is the international standard for the format logic of CD-ROM folders and files. For the ISO9660 format, there are regulations for the following two levels.

Level 1:

The file name is in 8.3 format (the name consists of up to 8 characters, half-byte English capital letters and half-byte numerals and the “_” sign, with a file-extension of three characters.)

Level 2:

The file name can have up to 31 characters (including the separation mark “.” and a file extension). Each folder contains less than 8 hierarchies.

Extended formats

Joliet:

File names can have up to 64 characters.

Romeo:

File names can have up to 128 characters.

Linear PCM (LPCM)/Pulse code modulation

This stands for linear pulse code modulation, which is the signal recording system used for music CDs and DVDs. Generally, DVDs are recorded with higher sampling frequency and bit rate than CDs. Therefore, DVDs can provide higher sound quality.

m3u

Playlists created using the “WINAMP” software have a playlist file extension (.m3u).

MP3

MP3 is short for MPEG Audio Layer 3. It is an audio compression standard set by a working

Additional Information

group (MPEG) of the ISO (International Standards Organization). MP3 is able to compress audio data to about 1/10th the level of a conventional disc.

MPEG

This stands for Moving Pictures Experts Group, and is an international video image compression standard. Some DVDs feature digital audio compressed and recorded using this system.

Multi-angle

With regular TV programs, although multiple cameras are used to simultaneously shoot scenes, only images from one camera at a time are transmitted to your TV. Some DVDs feature scenes shot from multiple angles, letting you choose your viewing angle as desired.

Multi-audio (Multilingual dialog)

Some DVDs feature dialog recorded in multiple languages. Dialog in up to 8 languages can be recorded on a single disc, letting you choose as desired.

Multi-session

Multi-session is a recording method that allows additional data to be recorded later. When recording data on a CD-ROM, CD-R or CD-RW, etc., all data from beginning to end is treated as a single unit or session. Multi-session is a method of recording more than 2 sessions on one disc.

Multi-subtitle

Subtitles in up to 32 languages can be recorded on a single DVD, letting you choose as desired.

Optical digital output/input

By transmitting and receiving audio signals in a digital signal format, the chance of sonic quality deteriorating in the course of transmission is minimized. An optical digital output/

input is designed to transmit and receive digital signals optically.

Packet write

This is a general term for a method of writing on CD-R, etc., at the time required for a file, just as is done with files on floppy or hard discs.

Parental lock

Some DVD video discs with violent or adult-oriented scenes feature parental lock which prevents children from viewing such scenes. With this kind of disc, if you set the unit's parental lock level, playback of scenes inappropriate for children will be disabled, or these scenes will be skipped.

Playback control (PBC)

This is a playback control signal recorded on Video CDs (Version 2.0). Using menu displays provided by Video CDs with PBC lets you enjoy playback of simple interactive software and software with search functions. You can also enjoy viewing high- and standard-resolution still images.

Region number

DVD players and DVD discs feature region numbers indicating the area in which they were purchased. Playback of a DVD is not possible unless it features the same region number as the DVD player. This unit's region number is displayed on the bottom of the unit.

Title

DVD video discs have high data capacity, enabling recording of multiple movies on a single disc. If, for example, one disc contains three separate movies, they are divided into title 1, title 2 and title 3. This lets you enjoy the convenience of title search and other functions.

Additional Information

VBR

VBR is short for variable bit rate. Generally speaking CBR (constant bit rate) is more widely used. But by flexibly adjusting the bit rate according to the needs of audio compression, it is possible to achieve compression-priority sound quality.

WMA

WMA is short for Windows Media™ Audio and refers to an audio compression technology that is developed by Microsoft Corporation. WMA data can be encoded by using Windows Media Player version 7 or later. Microsoft, Windows Media, and the Windows logo are trademarks, or registered trademarks of Microsoft Corporation in the United States and/or other countries. ▣

Additional Information

Specifications

General

Power source	14.4 V DC (10.8 – 15.1 V allowable)
Grounding system	Negative type
Max. current consumption	5.0 A
Dimensions (W × H × D):	
DIN	
Chassis	178 × 50 × 160 mm (7 × 2 × 6-1/4 in.)
Nose	188 × 58 × 30 mm (7-3/8 × 2-1/4 × 1-1/8 in.)
D	
Chassis	178 × 50 × 165 mm (7 × 2 × 6-1/2 in.)
Nose	170 × 46 × 25 mm (6-3/4 × 1-3/4 × 1 in.)
Weight	2.2 kg (4.8 lbs)

Display

Screen size/aspect ratio	6.5 inch wide/16:9 (effective display area: 144 × 77 mm)
Pixels	336,960 (1,440 × 234)
Type	TFT active matrix, transmissive type
Color system	NTSC
Operating temperature range	+14 – +122 °F
Storage temperature range	-4 – +176 °F
Angle adjustment	50 – 110° (initial settings: 110°)

DVD Player

System	DVD video, Video CD, Compact disc audio system
Usable discs	DVD video, Video CD, Compact disc
Region number	1
Signal format:	
Sampling frequency	44.1/48/96 kHz
Number of quantization bits	16/20/24; linear
Frequency response	5 – 44,000 Hz (with DVD, at sampling frequency 96 kHz)

Signal-to-noise ratio	97 dB (1 kHz) (IHF-A network) (CD: 96 dB (1 kHz) (IHF-A network))
Dynamic range	95 dB (1 kHz) (CD: 94 dB (1 kHz))
Distortion	0.008 % (1 kHz)
Output level:	
Video	1.0 Vp-p/75 Ω (±0.2 V)
Audio	1.0 V (1 kHz, 0 dB)
Number of channels	2 (stereo)
MP3 decoding format	MPEG-1 & 2 Audio Layer 3
WMA decoding format	Ver. 7 & 8



Note

Specifications and the design are subject to possible modifications without notice due to improvements. 

A

Angle icon 32, 59
 Aspect ratio 59, 80
 Audio language 31, 58

B

Bookmark 32
 Brightness 24

C

Chapter 80
 Code number 59
 Color 24
 Contrast 24

D

Direct search 31
 Dolby Digital 11, 80
 DTS 11, 80

H

Hue 25

L

Language code chart 79
 Linear PCM (LPCM) 80

M

Menu language 58
 MPEG 81
 Multi-angle 32, 81
 Multi-audio 31, 81
 Multi-subtitle 31, 81

O

Optical digital output/input 81

P

Parental lock 59, 81
 PBC (playback control) 33
 Playback control (PBC) 81

R

Region number 8, 81

S

Subtitle language 31, 57

T

Title 81
 TV aspect 59

V

Video CD 8

W

Wide screen mode 24

*Register your product at
Enregistrez votre produit au*

<http://www.pioneerelectronics.com>

*See "Product registration" page
Voir la page "Enregistrement du produit"*

PIONEER CORPORATION

4-1, MEGURO 1-CHOME, MEGURO-KU, TOKYO 153-8654, JAPAN

PIONEER ELECTRONICS (USA) INC.

P.O. Box 1540, Long Beach, California 90801-1540, U.S.A.
TEL: (800) 421-1404

PIONEER EUROPE NV

Haven 1087, Keetberglaan 1, B-9120 Melsele, Belgium
TEL: (0) 3/570.05.11

PIONEER ELECTRONICS ASIACENTRE PTE. LTD.

253 Alexandra Road, #04-01, Singapore 159936
TEL: 65-6472-1111

PIONEER ELECTRONICS AUSTRALIA PTY. LTD.

178-184 Boundary Road, Braeside, Victoria 3195, Australia
TEL: (03) 9586-6300

PIONEER ELECTRONICS OF CANADA, INC.

300 Allstate Parkway, Markham, Ontario L3R OP2, Canada
TEL: 1-877-283-5901

PIONEER ELECTRONICS DE MEXICO, S.A. de C.V.

Bldv.Manuel Avila Camacho 138 10 piso
Col.Lomas de Chapultepec, Mexico, D.F. 11000
TEL: 55-9178-4270

先鋒股份有限公司

總公司：台北市中山北路二段44號13樓
電話：(02) 2521-3588

先鋒電子（香港）有限公司

香港九龍尖沙咀海港城世界商業中心
9樓901-6室
電話：(0852) 2848-6488

Published by Pioneer Corporation.
Copyright © 2004 by Pioneer Corporation.
All rights reserved.

Printed in Japan

<CRB1967-A> UC

<KMMZF> <04C00000>