

Pioneer *sound.vision.soul*

Hardware Manual

ENGLISH

DVD Navigation Unit

AVIC-80DVD

Introduction



Dear Customer:

Selecting fine audio equipment such as the unit you've just purchased is only the start of your musical enjoyment. Now it's time to consider how you can maximize the fun and excitement your equipment offers. This manufacturer and the Electronic Industries Association's Consumer Electronics Group want you to get the most out of your equipment by playing it at a safe level. One that lets the sound come through loud and clear without annoying blaring or distortion—and, most importantly, without affecting your sensitive hearing.

Sound can be deceiving. Over time your hearing "comfort level" adapts to higher volumes of sound. So what sounds "normal" can actually be loud and harmful to your hearing. Guard against this by setting your equipment at a safe level BEFORE your hearing adapts.

To establish a safe level:

- Start your volume control at a low setting.
- Slowly increase the sound until you can hear it comfortably and clearly, and without distortion.

Once you have established a comfortable sound level:

- Set the dial and leave it there.

Taking a minute to do this now will help to prevent hearing damage or loss in the future. After all, we want you listening for a lifetime.

We Want You Listening For A Lifetime

Used wisely, your new sound equipment will provide a lifetime of fun and enjoyment. Since hearing damage from loud noise is often undetectable until it is too late, this manufacturer and the Electronic Industries Association's Consumer Electronics Group recommend you avoid prolonged exposure to excessive noise. This list of sound levels is included for your protection.

Decibel

Level	Example
30	Quiet library, soft whispers
40	Living room, refrigerator, bedroom away from traffic
50	Light traffic, normal conversation, quiet office
60	Air conditioner at 20 feet, sewing machine
70	Vacuum cleaner, hair dryer, noisy restaurant
80	Average city traffic, garbage disposals, alarm clock at two feet.

THE FOLLOWING NOISES CAN BE DANGEROUS UNDER CONSTANT EXPOSURE

90	Subway, motorcycle, truck traffic, lawn mower
100	Garbage truck, chain saw, pneumatic drill
120	Rock band concert in front of speakers, thunderclap
140	Gunshot blast, jet plane
180	Rocket launching pad

Information courtesy of the Deafness Research Foundation.



How To Read This Manual

This manual mainly describes hardware-related information such as the part names of the Navigation System or precautions for use. Please read this manual before using your Navigation System. The following issues are described in each chapter:

How to use this manual

Introduction

This chapter describes precautions for the use of the Navigation System.

How to Use Remote Control and Names of Parts

This section describes the functions of the Steering Remote Control used to operate the Navigation System. In addition, this chapter describes matters that are important to know before using the Navigation System, such as the names of each part, inserting/ejecting discs, or how to set a PC card.

Appendix

In this chapter, how to handle the Navigation System or discs, specifications of the Navigation System and how to reset the system are described.

Terminology

Before moving on, take a few minutes to read the following information about the conventions used in this manual. Familiarity with these conventions will help you greatly as you learn how to use your new equipment.

- Buttons on your Remote Control or display are referred to as:
Ex.) **NAVI** button, **NAVI MENU** button.
- Items in various menus or touch keys displayed on the screen are referred to like this:
Ex.) "**Destination**", "**Settings**".
- Extra information, alternative use and other notes are presented like this:
Ex.)
 - PC card can be set or removed regardless of the power ON/OFF of the main unit (ON/OFF of the engine).
- The references are indicated like this:
Ex.)
 - "Resetting the System" → Page 11

Table of Contents

Introduction 1

- How To Read This Manual 2
 - How to use this manual 2
 - Terminology 2
- Table of Contents 3
- Important Safety Information 3
- Notes Before Using the System 4
 - Important 4
 - Precaution 4
 - After-sales service for Pioneer products 5
 - Product registration 5

Chapter 1

How to Use Remote Control and Names of Parts 7

- Preparing the Remote Control 7
 - Inserting the battery for the Remote Control 7
- Getting to Know the Components and What They Do 8
 - The Steering Remote Control 8
 - Microphone 9
 - Main unit 9

Appendix 11

- Handling and Care of the Disc 11
- Resetting the System 11
- Specifications 12

Important Safety Information

Before using your Navigation System, be sure to read and fully understand the following safety information:

- Read the manual before operating this Navigation System.
- This Navigation System is intended solely as an aid to you in the operation of your car. It is not a substitute for your attentiveness, judgment, and care when driving.
- Do not operate this Navigation System if doing so in any way will divert your attention from the safe operation of your car. Always observe safe driving rules and follow all existing traffic regulations.
- Never allow others to use the system unless they have read and understood the operating instructions.
- Never use this Navigation System to route to hospitals, police stations, or similar facilities in an emergency. The map data may not include a comprehensive list of emergency service facilities.
- Route and guidance information displayed by this equipment is for reference purposes only. It may not accurately reflect the latest permissible routes, road conditions, or traffic restrictions.
- Traffic restrictions and advisories currently in force should always take precedence over guidance given by this product. Always obey current traffic restrictions, even if this product provides contrary advice.
- Failure to input correct information about the local time may result in the product providing improper routing and guidance instructions.
- Never set the volume of your Navigation System so high that you cannot hear outside traffic and emergency cars.
- To promote safety, certain functions are disabled unless the parking brake is on.
- The data encoded in the disc for this product is the intellectual property of the provider, and the provider is responsible for such content.
- As with any accessory in your car's interior, you should not allow this Navigation System to divert your attention from the safe operation of your car. If you experience difficulty in operating the system or reading the display, please make adjustments while safely parked.

Notes Before Using the System

Information to User

Alteration or modifications carried out without appropriate authorization may invalidate the user's right to operate the equipment.

Important

The serial number of this device is located on the bottom of this product. For your own security and convenience, be sure to record this number on the enclosed warranty card.

Precaution

- CAUTION: USE OF CONTROL OR ADJUSTMENT OR PERFORMANCE OF PROCEDURES OTHER THAN THOSE SPECIFIED HEREIN MAY RESULT IN HAZARDOUS RADIATION EXPOSURE.
- CAUTION: THE USE OF OPTICAL INSTRUMENTS WITH THIS PRODUCT WILL INCREASE EYE HAZARD.

Parking brake interlock

Certain functions offered by this Navigation System could be dangerous if used while driving. To prevent them being used while in motion, there is an interlock with your car's parking brake. If you attempt to use these functions during driving, it may be inoperable. If so, stop in a safe place, apply the parking brake, then operate.

Color difference of the map display between day and night



Night display (Ex. touch panel display)

The examples in this manual are illustrated using the daytime display. When driving at night, the colors you see may differ from those shown. To use this function, the Orange/white lead to this unit must be connected correctly.

➤ **Day/Night Display** → Operation Manual

Avoiding low battery

When using this unit, make sure to start your engine first. Using this unit without starting the engine will run down the battery.

About voice guidance (AVH-P7500DVD, AVH-P6500DVD)

There may be no voice guidance depending on a combined display unit. In that case, an external speaker (commercially available) must be connected to the SP-OUT jack (3.5 Ø MINI JACK, 1 W max [8 Ω]) on this unit's back.

After-sales service for Pioneer products

Please contact the dealer or distributor from where you purchased the product for its after-sales service (including warranty conditions) or any other information. In case the necessary information is not available, please contact the companies listed below:

Please do not ship your product to the companies at the addresses listed below for repair without making advance contact.

U.S.A

Pioneer Electronics
(USA) Inc.
CUSTOMER
SUPPORT DIVISION
P.O. Box 1760
Long Beach, CA
90801-1760
800 421-1404

CANADA

Pioneer Electronics of
Canada, Inc.
CUSTOMER
SATISFACTION
DEPARTMENT
300 Allstate Parkway
Markham, Ontario
L3R OP2
(905) 479-4411
1-877-283-5901

For warranty information, please see the Limited Warranty sheet included with your product.

Product registration

Visit us at the following site:

 <http://www.pioneerelectronics.com>

1. Register your product. We will keep the details of your purchase on file to help you refer to this information in the event of an insurance claim such as loss or theft.
2. Receive updates on the latest products and technologies.
3. Download owner's manuals, order product catalogues, research new products, and much more.

How to Use Remote Control and Names of Parts

Preparing the Remote Control

Some navigation operations can be performed with the Steering Remote Control provided. Prior to using the remote control, refer to the following to install the battery. If you are not combining with a touch panel display, you will need a separately sold remote control (CD-R11) to perform all navigation operations.

- ▷ For information on operating with the CD-R11 → "Operation Manual (For remote controlled types)" and the CD-R11 "Owner's manual".

Inserting the battery for the Remote Control

The following battery is used with the remote control.

Steering Remote : CR2032 (3V)

Steering Remote

Remove the cover on the back of the remote control and insert the lithium battery with the positive side (+) up. When changing the battery, use a probe with a fine non-metallic tip to remove the lithium battery.

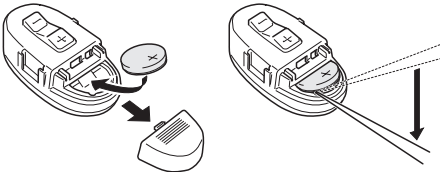

Warning

- **Keep the lithium battery out of reach of children. Should the battery be swallowed, immediately consult a doctor.**

Caution

- **Do not recharge, disassemble, heat or dispose of the battery in fire.**
- **Use a CR2032 (3V) lithium battery only. Never use other types of battery with this unit.**
- **Do not handle the battery with metallic tools.**
- **Do not store the lithium battery with metallic materials.**
- **When disposing of used batteries, please comply with governmental regulations or environmental public institution's rules that apply in your country/area.**
- **Always check carefully that you are loading the battery with its (+) and (-) poles facing in the proper directions.**
- **Remove the battery if remote control is not to be used for a month or longer.**
- **In the event of battery leakage, wipe the remote control completely clean and install a new battery.**

Getting to Know the Components and What They Do

Before using this unit, get to know the name of each component and how it is used.

The Steering Remote Control

Operation mode

By switching the Operation mode (Main mode, DIN mode, Navigation mode) you can use one remote control to operate different equipment.

Main mode :

Operates Pioneer AV Head Unit (e.g. AVH-P7500DVD, AVH-P6500DVD, AVH-P6400CD, AVH-P6400)

DIN mode :

Other Pioneer Head Unit operation

Navigation mode :

Navigation operation

First of all, set the Operation mode switching method. The Operation mode switching changes in accordance with the settings as below.

	Switching method	Setting method
Setting A	Main mode ↓ Navigation mode	Press the VOICE button while pressing the A.MENU button.
Setting B	DIN mode ↓ Navigation mode	Press the BACK button while pressing the A.MENU button.
Setting C	Navigation mode only	Press the SRC (SOURCE) button while pressing the A.MENU button.

- When using with the Pioneer AV Head Unit, set to Setting A. If you wish to operate another Pioneer Head Unit, set to Setting B. If you wish to use Navigation operation only, set to Setting C. ("Setting A" is default or factory setting.)

Main mode and DIN mode operation

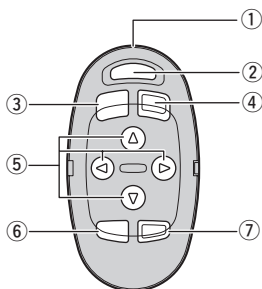

(1) Transmitter

This transmits the remote control signals.

(2) NAVI/AUDIO button

Pressing this button switches the Operation mode.

(3) VOICE button

You can use the **VOICE** button to start voice recognition, allowing you to operate the Navigation System by speech.

(4) SRC (SOURCE) button

Switches between sources and switches power ON/OFF. (Depending on the connected units, operation may differ slightly. Refer to "Switching the Sources" in the connected unit's instructions.)

(5) ▲, ▼, ◀, ▶ button

Operates the same as the Head Unit's ▲, ▼, ◀, ▶ button or the Joystick.

(6) BACK button

Main mode : **BACK** button

Return to the previous screen.

DIN mode : **FUNCTION** button

FUNCTION menu is displayed.

(7) A.MENU button

Main mode : **AUDIO MENU** button

Display the menu.

DIN mode : **AUDIO** button

AUDIO menu is displayed.

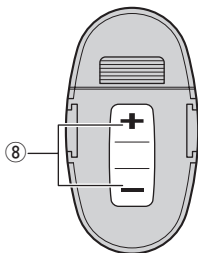
**(8) +/- button**

The Pioneer Head Unit's sound volume can be adjusted.

Navigation mode (navigation operation)

- The **SRC (SOURCE)** button, and **◀/▶** buttons are not used in Navigation mode.

(1) Transmitter

See Main/DIN mode.

(2) NAVI/AUDIO button

See Main/DIN mode.

(Setting C does not need this button.)

(3) VOICE button

See Main/DIN mode.

(5) ▲/▼ button

The map can be enlarged or reduced. If a menu list extends over several pages, switch to the previous page or the next page.

(6) NAVI button

Press this button to view the map or return to guidance. Also, when the map is scrolling, pressing this button returns you to the display of the map of your surroundings.

(7) GUIDE/TRAFFIC button

Press this button if you want to hear the voice guidance again.

(8) +/- button

The volume of the navigation guide voice can be adjusted.

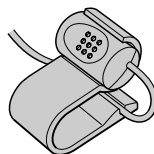
Microphone**(1) Microphone**

After pressing the **VOICE** button to start voice operation, this microphone hears your commands.

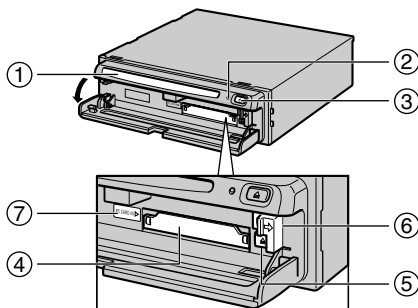
Main unit**(1) Disc loading slot****(2) Reset button**

If the system malfunctions, reset it by pressing this recessed button with a ballpoint pen or similar pointed object.

➤ "Resetting the System" → Page 11

(3) Disc eject button**(4) PC card slot****(5) PC card eject button**

Remove the PC card by pressing this button.

(6) PC card lock lever

This lever is used to remove the PC card.

(7) PC card lock lamp

The red light goes on when the PC card is inserted and a proper connection is made.

Setting and removing the disc

Insert the disc in the Disc loading slot with the label-side up. To remove the disc, press the Disc eject button on the right-hand side of the Disc loading slot.

- Do not try to use discs other than a disc designed for this system. Please use only the disc specified by Pioneer.

Setting the PC card

Open the cover at the front of the main unit. Hold the PC card label-side up; the arrow shows the direction of insertion. Insert the card firmly until the PC card eject button pops out. If the main unit power is on, the PC card lock lamp changes from green to red, showing that the PC card is inserted correctly and ready for use.

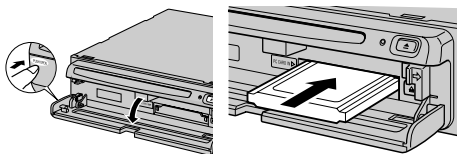

Removing the PC Card

Caution

- **Do not remove the PC card while the PC card lock lamp is red. It may damage the main unit of the Navigation System or the PC card.**

Open the cover on the front of the main unit. Slide the PC card lock lever to the right (1), and hold it there. Check that the PC card lock lamp has changed to green, and then press the PC card eject button (2). (Keep holding the PC card lock lever to the right until the PC card is removed completely.)

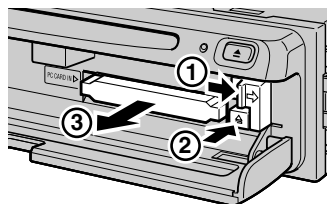

- PC card can be set or removed regardless of the power ON/OFF of the main unit (ON/OFF of the engine).
- You can only use a card that conforms to the PCMCIA Type II (5V) standard. If you attempt to use a card complying with a different standard, the card slot may be damaged, or a malfunction may occur.
- Do not remove the card while editing the data on the PC card. The data stored on the Navigation unit and data on the PC card could be corrupted.

Appendix

Handling and Care of the Disc

Some basic precautions are necessary when handling your discs.

Discs you can use

- Do not use discs other than those intended for this product. Use only discs approved by Pioneer.

DVD-ROM drive and care

- Use only normal, round discs, if you insert irregular, non-round, shaped discs they may jam in the DVD player or not play properly.



- Check all discs for cracks, scratches or warping before playing. Discs that have cracks, scratches or are warping may not play properly. Do not use such discs.
- Avoid touching the recorded (non-printed side) surface when handling the disc.
- Store discs in their cases when not in use.
- Keep discs out of direct sunlight and do not expose the discs to high temperatures.
- Do not attach labels, write on or apply chemicals to the surface of the discs.
- To clean dirt from a disc, wipe the disc with a soft cloth outward from the center of the disc.



- If the heater is used in cold weather, moisture may form on components inside the DVD-ROM drive. Condensation may cause the DVD-ROM drive to not operate properly. If you think that condensation is a problem turn off the DVD-ROM drive for an hour or so to allow the DVD-ROM drive to dry out and wipe any damp discs with a soft cloth to remove the moisture.
- Road shocks may interrupt disc playback.

Ambient conditions for playing disc

- At extremely high temperatures, a temperature cutout protects the Navigation System by switching it off automatically.
- Despite our careful design of the product, as a result of mechanical wear, ambient conditions for use, or handling of the disc, small scratches that do not affect actual operation may appear on the disc surface. This is not a sign of the malfunction of the unit. Consider it to be normal wear and tear.

Resetting the System

On occasion, you may need to reset your Navigation System.

When a reset is necessary

You should reset the system in the following situations:

- After installation of this unit in your car.
- If there appear to be problems with the operation of the system.
- If there are problems with the display.
- When changing the combination of the equipment.

Using the reset button

The reset button is recessed in the front of the main unit to prevent it being pressed accidentally. Look for it at the top right-hand corner of the front panel.

Insert a pointed implement such as a ballpoint pen into the small hole and push.

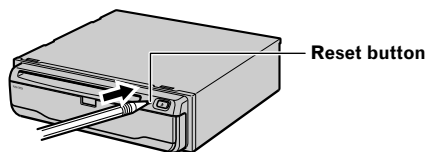

If you have connected other equipment (for example, a display or AV Head Unit) to this by cable, be sure to reset that equipment too.

Specifications

Main unit

(GPS receiver)

System	L1, C/Acode GPS SPS (Standard Positioning Service)
Reception system	8-channel multi-channel reception system
Reception frequency	1,575.42 MHz
Sensitivity	-130 dbm
Position update frequency..	Approx. once per second

(Common)

Max. output impedance	1 Vp-p, 75 Ω
Maximum current consumption	2 A
Power source	DC 14.4 V (10.8 - 15.1 V allowed)
Ground type.....	Negative type

GPS antenna

Antenna.....	Micro strip flat antenna/ right-handed helical polar- ization
Antenna cable.....	5.0 m (16 ft. 5 in.)

Dimensions

Main unit.....	178(W) \times 50(H) \times 178(D) mm (7 \times 2 \times 7 in.)
GPS antenna.....	34(W) \times 13(H) \times 36(D) mm (1-3/8 \times 1/2 \times 1-3/8 in.)
Steering remote control	35(W) \times 65(H) \times 24(D) mm (1-3/8 \times 2-1/2 \times 1 in.)

Weight

Main unit	1.5 kg (3.3 lbs)
GPS antenna	105 g (0.23 lbs)
Steering remote control	51 g (including holder and battery) (0.2 lbs)

Note:

- The specifications and design are subject to change without prior notice. The product purchased may differ in detail from illustrations in this manual.

Register your product at

<http://www.pioneerelectronics.com>

See "Product registration" page

PIONEER CORPORATION

4-1, MEGURO 1-CHOME, MEGURO-KU, TOKYO 153-8654, JAPAN

PIONEER ELECTRONICS (USA) INC.

P.O. Box 1540, Long Beach, California 90801-1540, U.S.A.
TEL: (800) 421-1404

PIONEER EUROPE NV

Haven 1087, Keetberglaan 1, B-9120 Melsele, Belgium
TEL: (0) 3/570.05.11

PIONEER ELECTRONICS ASIACENTRE PTE. LTD.

253 Alexandra Road, #04-01, Singapore 159936
TEL: 65-6472-1111

PIONEER ELECTRONICS AUSTRALIA PTY. LTD.

178-184 Boundary Road, Braeside, Victoria 3195, Australia
TEL: (03) 9586-6300

PIONEER ELECTRONICS OF CANADA, INC.

300 Allstate Parkway, Markham, Ontario L3R 0P2, Canada
TEL: (905) 479-4411

PIONEER ELECTRONICS DE MEXICO, S.A. de C.V.

Bldv.Manuel Avila Camacho 138 10 piso
Col.Lomas de Chapultepec, Mexico, D.F. 11000
TEL:55-9178-4270

先鋒股份有限公司

總公司: 台北市中山北路二段44號13樓
電話: (02) 2521-3588

先鋒電子(中國)有限公司

香港辦事處: 香港銅鑼灣告士打道280號世界貿易中心
17樓1704-06室
電話: (0852) 2848-6488

Published by Pioneer Corporation.
Copyright © 2003 by Pioneer Corporation.
All rights reserved.

Publication de Pioneer Corporation.
Copyright © 2003 Pioneer Corporation.
Tous droits de reproduction et de traduction
réservés.