



DVD-V7200

Industrial DVD Player

RS-232C

COMMAND PROTOCOL MANUAL

PRELIMINARY

Version 2.20

October 7, 1999

Pioneer Corporation
Pioneer New Media Technologies, Inc.

This manual is copyrighted with all rights reserved. No part of this document may be reprinted, produced, translated or utilized in any form or by any means now known or hereafter invented including, but not limited to, any electronic, mechanical, photocopying and recording or information storage and retrieval system means, without the express written permission from Pioneer New Media Technologies, Inc.

Every effort has been made to ensure that the information in this manual is accurate. Pioneer is not responsible for printing or clerical errors.

Information in this document is subject to change without notice.

Copyright (c) 1998 Pioneer New Media Technologies, Inc.

Document No. DVDV7200RS002-0398

Printed in the United States of America.

Mention of third-party products is for informational purposes only and contributes neither an endorsement nor a recommendation. Pioneer assumes no responsibility with regard to the performance or use of these products.

No investigation has been made of common-law trademark rights in any word. Words that are known to have current registrations are shown with an initial capital. Many, if not all, hardware and/or software products referenced in this manual are identified by their trade names. Most, if not all, of these designations are claimed a legally protected trademarks by the companies that make the product. It is not Pioneer's intent to use any of these names generically and cautions the reader to investigate any claimed trademark before using it for any purpose other than to refer to the product to which the trademark is attached.

Pioneer makes no warranty of any kind, expressed or implied, about the contents of this manual, the merchantability of the product or the product's fitness for any particular purpose.

Every precaution has been taken in the preparation of this manual. Although we tried to thoroughly check that all instructions and information in this manual are accurate and correct, Pioneer can not be and is not responsible, in whole or in part, for any damage or loss to your data and/or equipment that results from your use of this document or from any information contained herein including, but not limited to, any errors, omissions or typos that may have resulted in an incorrect operation or installation.

FCC INFORMATION

The equipment described in this manual has been tested and found to comply with the limits for a Class B digital device in accordance with the specifications in Part 15 of FCC rules. These specifications are designed to provide reasonable protection against radio and television reception interference in a residential installation. There is no guarantee that interference will not occur in a particular installation.

To determine if your player is causing interference, turn the device off. If the interference stops, it was most likely caused by the player. To eliminate the interference, you may try one or more of the following corrective measures:

- verify the cables and connectors between components are shielded.
- increase separation between the player and components.
- connect the changer into an outlet or circuit different from that which the components are connected.
- consult dealer or experienced radio/television technician for help.

The Federal Communications Commission offers a handbook that may help you with eliminating interference. The handbook is titled *Interference Handbook* (stock number 004-000-00493-1) and may be ordered from the U.S. Government Printing Office, Washington, D.C. 20402.

Warning: Any changes or modifications to this product that are not authorized by Pioneer could void the FCC Certification and negate the user's authority to operate the equipment.

DOC CLASS B COMPLIANCE

This digital apparatus does not exceed the Class B limits for radio noise emissions from digital apparatus set out in the radio interference regulations of the Canadian Department of Communications.

SAFETY CAUTION

Care should always be taken when working with electronic devices. To protect you and your DVD-V7200 player from damage or harm, it is important that you first read and then carefully follow the instructions in this documentation. Take particular care to heed all warnings and cautions marked on the unit and outlined in this document and the accompanying *DVD-V7200 Industrial Player Operating Instructions*. **IGNORING ANY OR ALL INSTRUCTIONS AND WARNINGS MAY CAUSE INJURY TO THE PERSON(S) OPERATING THE EQUIPMENT, DAMAGE TO THE PRODUCT OR BOTH.**

Table of Contents

1.	INTRODUCTION	1
2.	INTERFACE	2
2.1	Interface Connector	2
2.2	Serial Interface Pin Specification	2
2.3	Computer Control Functions	2
2.3.1	Serial Control (see Chapters 3, 4, 5 and 6)	2
2.3.2	External Switch Control (see Chapter 9)	3
2.3.3	External Power Control	3
3.	SERIAL CONTROL	4
3.1	Serial Interface Specifications	4
3.1.1	Signal Interface	4
3.1.2	Data Type	4
3.1.3	Data Transfer Speed (Baud rate)	4
3.2	Communication with a Computer	4
3.3	Command and Status	5
3.4	Error Messages	7
3.5	Initial Setting	7
4.	COMMAND STRUCTURE	9
4.1	Command Mnemonic	11
4.2	Argument	11
4.3	Command String	13
4.4	Status Returns	13
4.5	Error Message	13
4.6	Request Status Return	13
4.7	Timing	14
5.	COMMAND DESCRIPTIONS	15
5.1	Open	15
5.2	Close	15
5.3	Reject	15
5.4	Start	16
5.5	Play	16
5.6	Pause	17
5.7	Still (DVD, VCD)	18
5.8	Step Forward (DVD, VCD)	18
5.9	Step Reverse (DVD)	18
5.10	Scan Forward	19
5.11	Scan Reverse	19

5.12	Scan Stop	19
5.13	Multi-Speed Forward (DVD, VCD)	20
5.14	Multi-Speed Reverse (DVD)	20
5.15	Speed (DVD, VCD)	21
5.16	Search.....	22
5.17	Search & Play.....	23
5.18	Stop Marker.....	24
5.19	Lead-Out Symbol.....	25
5.20	Clear	26
5.21	Frame (DVD)	26
5.22	Block Number (CD, VCD).....	27
5.23	Time (except disc which time code is not recorded).....	27
5.24	Chapter (DVD).....	27
5.25	Title (DVD).....	28
5.26	Index (CD, VCD)	28
5.27	TRACK (CD, VCD)	28
5.28	Select Subtitle (DVD)	29
5.29	Select Audio (DVD).....	29
5.30	Select Aspect.....	29
5.31	Select Angle (DVD).....	30
5.32	Select Parental-Level (DVD)	30
5.33	Audio Control.....	30
5.34	Video Control.....	31
5.35	Display Control.....	31
5.36	Key Lock	32
5.37	Stack Group Set (DVD).....	33
5.38	Barcode /Command Stack Play (DVD).....	33
5.39	Video Blackboard Display (DVD)	34
5.40	Video Blackboard Clear	34
5.41	Blackboard / Stack Data Upload.....	35
5.42	Blackboard / Stack Data Download	41
5.43	Weekly Timer Data Upload	42
5.44	Weekly Timer Data Download.....	46
5.45	Text File Data Upload	47
6.	CURRENT Player CONDITION REQUEST DESCRIPTIONS.....	49
6.1	P-Block Number Request	49
6.2	Title/Track Number Request.....	49
6.3	Chapter Number Request (DVD)	50
6.4	Time Code Request.....	50
6.5	Index Number Request (CD, VCD).....	51

6.6	Frame Number Request (DVD).....	51
6.7	Block Number Request (CD, VCD)	52
6.8	Total Frame Request (DVD).....	52
6.9	TOC Information Request (CD/VCD).....	52
6.10	Disc Region Code Request	53
6.11	DVD Disc Status Request.....	53
6.12	LD Disc Status Request (LB-compatible DVD)	54
6.13	CD Disc Status Request.....	54
6.14	Register A Set	55
6.15	Register B Set.....	57
6.16	Register D Set	58
6.17	Print Character.....	58
6.18	Clear Screen.....	59
6.19	Real Time Clock Set.....	59
6.20	Advanced Feature Menu Set.....	60
6.21	Communication Control Set.....	61
6.22	Player Active Mode Request.....	62
6.23	Player Model Name Request.....	62
6.24	Real Time Clock Request	63
6.25	Advanced Feature Menu Request.....	63
6.26	Player Region Code Request.....	64
6.27	CCR Mode Request	64
6.28	Input Number Request.....	64
6.29	Error Code Request.....	64
6.30	Input Unit Request	65
6.31	Input Barcode Data Request	65
6.32	Register A Request	66
6.33	Register B Request.....	66
6.34	Register D Request	67
6.35	Menu Call (DVD)	67
6.36	Numeric Button (DVD)	68
6.37	Button Select (DVD)	68
6.38	Enter Button (DVD)	69
6.39	Get Information (DVD)	70
7.	OPERATING MODES.....	73
7.1	Open.....	73
7.2	Park.....	73
7.3	Setup.....	73
7.4	Random Access	73
7.5	Reject.....	74

8.	DVD-V7200 INTERNAL REGISTERS.....	75
8.1	Current Time/Frame	75
8.2	P-TIME.....	75
8.3	Current Title/Track (Current Chapter).....	75
8.4	Current Index.....	75
8.5	Serial Digit Buffer.....	75
8.6	Remote Control Use Address Flag.....	75
8.7	Remote Control Digit Buffer.....	75
8.8	Remote Control Data Register.....	76
8.9	Laser Barcode Buffer	76
8.10	Serial Use Address Flag.....	76
8.11	Search Time/Frame	76
8.12	Search Title/Track (Search Chapter).....	76
8.13	Search Index.....	76
8.14	Mark Time/Frame	76
8.15	Mark Title/Track (Mark Chapter).....	76
8.16	Mark Index.....	77
8.17	Video Control.....	77
8.18	Audio Control.....	77
8.19	Display Control.....	77
8.20	Registers	77
9.	EXTERNAL SWITCH CONTROL.....	80
9.1	Function Assignment.....	80
9.2	Controller	81
9.2.1	Simple Circuit	82
9.2.2	Diode Matrix Circuit.....	83
10.	ADDITIONAL NOTES	84
	Appendix A - Complete Command List by Name	85
	Appendix B - Complete Command List by Mnemonic.....	87
	Appendix C - DVD Command List.....	89
	Appendix D - LB Compatible DVD Command List.....	91
	Appendix E - CD Command List.....	93
	Appendix F - VCD Command List	95

1. INTRODUCTION

This document defines the RS-232C command protocol for the Pioneer DVD-V7200 Industrial DVD Player.

The DVD-V7200 is capable of playing DVD, CD and VCD discs. The device has three control methods: front panel, remote control or computer interface through the RS-232C serial port.

This manual addresses the various commands and precautions required when using the player with a computer. Please refer to the *DVD-V7200 Operating Instructions* included in this bundle for details on operating the unit via the front panel and/or remote control.

Chapter 2 describes the Interface Connector Specifications and the Computer Control features of the DVD-V7200.

Chapter 3 discusses Baud Rate Settings, Interface Operation, Control Protocol, and Internal Operation via computer.

Chapter 4 explains the Player Command Structure in detail.

Chapter 5 reviews each command in detail.

Chapter 6 defines Address and Player Condition requests.

Chapter 7 relates to the various operating modes.

Chapter 8 discusses the internal registers.

Chapter 9 details the external switch control functions.

NOTE: In this manual, a DVD disc containing a modified program from a current educational Laser Disc (LD) is handled as a Laser BarCode (LB) compatible DVD disc. The disc has two formats: CAV and CLV.

Please be careful the following. The commands in this manual, it is not the same as LD players one. Both are exactly like but a little different in the detailed using.

CAUTION: The material in this manual is subject to change without notice.

2. INTERFACE

2.1 Interface Connector

A computer may be connected to the DVD-V7200 through either the RS-232 serial port or the parallel port by using a 15-pin D-Sub connector (e.g., a JAE DALC-J15SAF connector with suitable plug such as the JAE DA-15PF-N).

The pins are identified below:

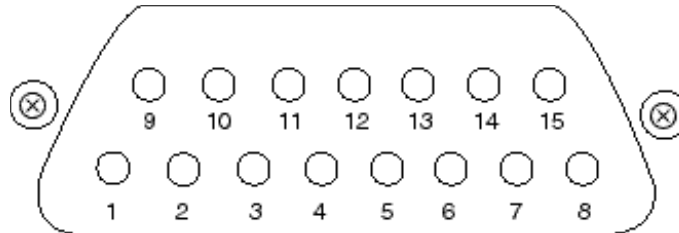

2.2 Serial Interface Pin Specification

Pin No.	Terminal	Input/Output	Function
1	GND	--	ground
2	TxD	Output	send data
3	RxD	Input	receive data
4	DTR	Output	enable data receiving
5	POWER	Output	external power control
6	SW1	Input	
7	SW2	Input	
8	SW3	Input	
9	SW4	Input	
10	SW5	Input	
11	SW6	Input	
12	SW7	Input	
13	SW8	Input	
14	DLTST	INPUT	used only service support (do not make connection)
15	V +8V	OUTPUT	used only service support (do not make connection)

2.3 Computer Control Functions

2.3.1 Serial Control (see Chapters 3, 4, 5 and 6)

The player and computer are based upon the RS-232C protocol and are connected through the TxD, RxD, DTR and GND terminals.

2.3.2 External Switch Control (see Chapter 9)

Control the player with the External Option Switches (SW#).

Please make sure the Key Lock condition. If the player is in the Key Lock mode, the player ignores the control. (Please refer to the Key Lock command description.)

2.3.3 External Power Control

Control the player's power with the Power pin within the Interface Connector.

If the player detects a high signal throughput (100m/sec or more) during the Standby mode, the player powers on. If the player detects the same signal during the Power On mode, the player powers off and switches to the Standby mode.

The specifications for the Power pin are as follows:

Maximum Input Voltage	Less Than μ 12V
High Level Signal	More Than 4.5V
Low Level Signal	Less Than 0.5V

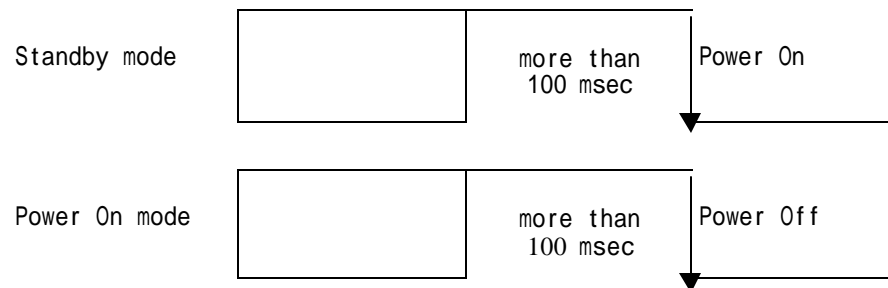

Please make sure the Key Lock condition. If the player is in the Key Lock mode, the player ignores the control. (Please refer to the Key Lock command description.)

3. SERIAL CONTROL

3.1 Serial Interface Specifications

3.1.1 Signal Interface

The signal interface is an RS-232C connection.

3.1.2 Data Type

Data Length: 8 bit

Stop Bit: 1 bit

Parity bit: No Parity

3.1.3 Data Transfer Speed (Baud rate)

The data transfer speed can be set to either 4800 or 9600 baud on the Industrial player menu screen and/or with the Advanced Feature Menu Set command.(Please refer to the DVD-V7200 Operating Instructions and/or the Advanced Feature Menu Set command description.)

NOTE: The factory default is 4800 baud. The player memorizes the transfer speed every time and that is retained after the power cycle reaches completion.

3.2 Communication with a Computer

The DVD-V7200 communicates to the computer through the player's RS-232C port using pins 2 and 3 for communication and Pin 1 for grounding. Control or "handshaking" lines other than the TxD and RxD connections are not required. Please refer to the diagram below for clarification.

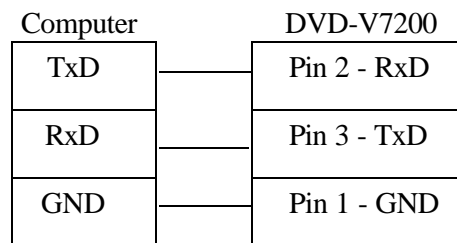

In some computer, the CTS port should be set to HIGH during the communication. It is the best thing to connect the CTS of the computer to the DTR of the player. In normal operation and communication is available, the DTR in the player is set to HIGH thus the unit is able to receive a command at any time.

3.3 Command and Status

The computer transmits a command to the DVD-V7200 and the player responds with the message, 'execution complete'.

Example

<u>COMPUTER</u>		<u>DVD-V7200</u>
(1) "Search to Frame 1000"	P	(2) Search Execution
	Ü	(3) Complete
(4) "Play to Frame 2000"	P	(5) Play Execution
	Ü	(6) Complete

NOTE: The length of a command string is limited to 32 characters. Please refer to COMMAND STRUCTURE.

When using a computer to control the DVD-V7200 player, follow the command protocols listed below:

- ASCII character codes are used for the actual commands and status response
- Command mnemonic is expressed as two (2) ASCII characters
- Uppercase letters are recommended; however, usually there are no distinctions between the use of uppercase or lowercase letters
- Some commands require an argument, (e.g. chapter number or speed)
- Use a command as the terminator of the argument

The player executes a command as soon as the carriage return <CR> is received. The <CR> acts as the command line terminator.

Example

```
CH<CR>      : Set chapter for address mode
10SE<CR>    : Search to chapter 10
```

The player has a command buffer, which stores a command string of up to 32 characters in length.

Example

```
10SE 20PL<CR> : Search to chapter 10 then play to 20
```

The command string enters into the buffer with the left character and continues sequentially from left to right. When the <CR> is entered, the commands are executed sequentially beginning with the first command in the buffer. In the example above, the first command is 10SE.

NOTE: The player ignores codes in the command string such as <SPACE> or <LF> (line feed) which do not affect the player's operation.

NOTE: Some commands, sent after a specialty command which includes an AUTOSTOP setting, (PL, MF, MR, etc.), cause the player to execute the new command before the AUTOSTOP is enacted (see Chapter 5, Command Descriptions).

When all the commands in a string have finished executing, the player transmits or *returns* the "complete" message.

The player returns an R after a command has been executed. This response is called the Automatic Status. The Automatic Status signals the computer program to send the next command. If this function is not used, the command processing time must be taken into consideration before the next command is sent.

If an error occurs, the player returns an error message such as E04. The message indicates an error has occurred as well as the type of error. Error messages are in the form of EXX where XX represents a 2-digit error code.

In some cases, an incorrect command sends the player to search within a non-recorded area and the player returns an error message. Use the Request Status function to determine the unit's current status (actual player hardware failures are rare).

Apply one of the following methods to reset the player after an error has occurred:

- Use ?P to determine the Active mode of the player
- Use ?X, ?W, ?M, ?H, ?H ?S to determine the player information, model name, clock time, player region code, the setting of Industrial Player Menu, etc.
- Use ?F, ?T, ?C, or ?R to determine the current frame, time, chapter, title/track number, respectively.
- Use ?V, ?D, ?K, ?G, ?Y, or ?Q to determine the disc information, disc type, total frame number, TOC information, etc.

The status functions are summarized below:

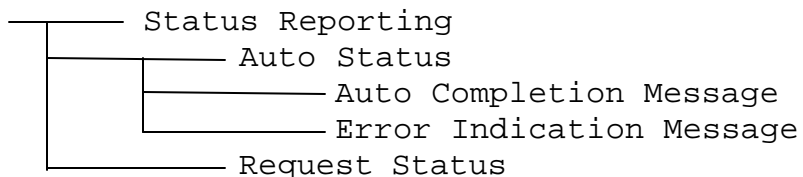

3.4 Error Messages

If an error occurs during a command execution, the player returns an error code. The table below lists each code with a description of the error:

Code	Message	Description
E00	Communication error	<i>Communication Line Error due to framing error or buffer overflow</i>
E04	Feature not available	<i>Non-Usable Function has been tried – either the command mnemonic is wrong or the command can not be used in this mode</i>
E06	Missing argument	<i>Correct parameter is not specified</i>
E11	Disc does not exist	<i>There is no disc in the tray</i>
E12	Search error	<i>Search address can not be found</i> <i>Read error of Text File; (When the command (UU) is executed)</i>
E15	Picture stop	<i>Playback has been stopped by a picture stop code while in the Auto Play mode</i>
E16	Interrupt by other device	<i>The command(s) sent via the serial line were not executed before commands were sent from the front panel buttons and/or remote control unit</i> <i>Forced end of the data transfer while Text File sends to PC (When the command (UU) is executed)</i>
E99	Panic	<i>Unrecoverable Error occurred – possible that a disc cannot be loaded and/or playing can not continue</i>

3.5 Initial Setting

The following table provides the default internal register and switch settings. Take care to set each to the required parameters when creating an application program.

Register/Switch	Setting at Power ON
Key Lock	2 : If set 2 at power OFF 0 : All other cases
Video Switch	1 : ON
Audio Switch	3 : Audio 1
Display Switch	0 : OFF
Address mode	1 : Time
Speed Parameter	30 : ½ Speed
CCR	3 : Mode 3
Register A	3 : Title/Chapter and Frame Display (DVD) Track/Time Display (CD, VCD)
Register B	0 : Normal Squelch
Register D	0 : CR

4. COMMAND STRUCTURE

The DVD-V7200 supports the commands listed below.

COMMAND		SUPPORTING FORMATS			
Name	Mnemonic	DVD	LB comp. DVD	CD	VCD
Open	OP	X	X	X	X
Close	CO	X	X	X	X
Reject	RJ	X	X	X	X
Start	SA	X	X	X	X
Play	(adrs) PL	X	X	X	X
Pause	PA	X	X	X	X
Still	ST	X	X		X
Step Forward	SF	X	X		X
Step Reverse	SR	X	X		
Scan Forward	NF	X	X	X	X
Scan Reverse	NR	X	X	X	X
Scan Stop	NS	X	X	X	X
Multi-Speed Forward	(adrs) MF	X	X		X
Multi-Speed Reverse	(adrs) MR	X	X		
Speed	arg SP	X	X		X
Search	adrs SE	X	X	X	X
Search & Play * 1	adrs SL	X	X	X	X
Stop Marker	adrs SM	X	X	X	X
Lead Out Symbol	LO	X	X	X	X
Clear	CL	X	X	X	X
Frame	FR	X	X		
Block Number	BK			X	X
Time	TM	X	X	X	X
Chapter	CH	X	X		
Title	TI	X	X		
Index	IX			X	X
Track	TR			X	X
Select Subtitle	arg SU	X	X		
Select Audio	arg AU	X	X		
Select Aspect	arg AP	X	X		
Select Angle	arg AG	X	X		
Select Parental-Level	arg PT	X	X		
Audio Control	arg AD	X	X	X	X
Video Control	arg VD	X	X	X	X
Display Control	arg DS	X	X	X	X
Keylock	arg KL	X	X	X	X
Stack Group Set	arg GP	X	X		
Barcode / Command Stack Play	arg BS	X	X		
Video Blackboard Display	arg VS	X	X		
Video Blackboard Clear	CB	X	X		
Blackboard / Stack Data Upload *1	BU	X	X	X	X
Blackboard / Stack Data Download *1	BD	X	X	X	X

PIONEER DVD-V7200 Industrial DVD Player RS-232 Command Protocol Manual

Weekly Timer Data Upload *1	WU	X	X	X	X
Weekly Timer Data Download *1	WD	X	X	X	X
Text File Data Upload *1	UU	X	X		

COMMAND		SUPPORTING FORMATS			
Name	Mnemonic	DVD	LB comp. DVD	CD	VCD
Current Address Request	?A	X	X	X	X
Title/Track Number Request	?R	X	X	X	X
Chapter Number Request	?C	X	X		
Time Code Request	?T	X	X	X	X
Index Number Request	?I			X	X
Frame Number Request	?F	X	X		
Block Number Request	?B			X	X
Total Frame Request	?Y	X	X		
TOC Information Request	?Q			X	X
Disc Region Code Request	?G	X	X		
DVD Disc Status Request	?V	X	X		
LD Disc Status Request	?D		X		
CD Disc Status Request	?K			X	X
Register A Set (Display)	arg RA	X	X	X	X
Register B Set (Squelch)	arg RB	X	X	X	X
Register D Set (TxD Term) *1	arg RD	X	X	X	X
Print Character	arg PR	X	X	X	X
Clear Screen	CS	X	X	X	X
Real Time Clock Set	WW	X	X	X	X
Advanced Feature Menu Set *1	arg MS	X	X	X	X
Communication Control Set	arg CM	X	X	X	X
Player Active Mode Request	?P	X	X	X	X
Player Model Name Request	?X	X	X	X	X
Real Time Clock Request	?W	X	X	X	X
Advanced Feature Menu Request *1	?S	X	X	X	X
Player Region Code Request	?H	X	X	X	X
CCR Mode Request	?M	X	X	X	X
Input Number Request	?N	X	X	X	X
Error Code Request	?E	X	X	X	X
Input Unit Request	#I	X	X	X	X
Input Barcode Data Request	#B	X	X	X	X
Register A Request	\$A	X	X	X	X
Register B Request	\$B	X	X	X	X
Register D Request *1	\$D	X	X	X	X
Menu Call *2	arg MC	X	X		
Numeric Button *2	arg NB	X	X		
Button Select *2	arg CU	X	X		
ENTER Button *2	(arg) ET	X	X		
Get Information *2	arg GI	X	X		

NOTE: Any command prefaced with an *1 is supported by a firmware Version 2.00.

NOTE: Any command prefaced with an *2 is supported by a firmware Version 2.20.

NOTE: A command with an argument or address parameter is prefaced by `arg` (argument) or `ards` (address). If the `arg` or `ards` is in parentheses (), the parameter is optional.

4.1 Command Mnemonic

Each command is expressed as two (2) ASCII alphabetic characters. There is no distinction between uppercase and lowercase letters except the Character strings in PR command.

NOTE: All command without Text File Data Upload (UU), Reject (RJ) and Open (OP) can not use while the video text is displayed on the screen. When any command without these are issued, the player returns the error code E04.

4.2 Argument

An argument is expressed in either ASCII characters or ten digits and consists of either an address or an integer. A Control Register uses an integer value to set a specified value or condition.

If a command requires an argument, it is always placed before the command.

Example : $N_1N_2N_3$
 minimum 000 ~ maximum 300 (except MS command)
 Minimum 000 ~ maximum 520703 (Only MS command)

NOTE: If a command requires an argument but one is not supplied, the player returns an error message.

An Address can be a title, a chapter, a track, an index number, a frame number, or a time code depending upon how the address flag is set. The Address must not exceed the maximum allowed value of ten characters and/or digits.

Address Type	Media Type	Format	Range (Min-Max)
Title Number	DVD	N_1N_2	0 ~ 99
Chapter Number	DVD	N_1N_2	0 ~ 99
Frame Number	DVD/VCD	$N_1N_2N_3N_4N_5N_6N_7^a$	0 ~ 1079999
Time Code	DVD	$N_1N_2N_3N_4N_5^b$	0 ~ 59959
	CD/VCD	$N_1N_2N_3N_4^c$	0 ~ 9959
Track Number	CD/VCD	N_1N_2	1 ~ 99
Index Number	CD/VCD	N_1N_2	1 ~ 99
Block Number	CD/VCD	$N_1N_2N_3N_4N_5N_6^d$	0 ~ 995974

^a $N_aN_bN_c$ minutes N_dN_e seconds are calculated into frame number.

^b $N_1N_2N_3$ minutes N_4N_5 seconds.

^c N_1N_2 minutes N_3N_4 seconds.

^d N_1N_2 minutes N_3N_4 seconds N_5N_6 block.

4.3 Command String

A command string consists of multiple commands on one line. The maximum length of a command string is 32 characters. All command strings are terminated by the Carriage Return <CR> code (0DH hex).

Example : FR2000SE 2300PL<CR>

NOTE: The Real Time Clock Set (RW) , Print Character (PR), Blackboard/Stack Data Upload (BU), Blackboard/Stack Data Download (BD), Weekly Timer Data Upload (WU), Weekly Timer Data Download (WD), Text File Data Upload (UU) commands should be assigned individually.

Once the <CR> termination command is added to the string, the command string is evaluated and executed from left to right in sequential order.

If an error occurs during the execution of a command string, the remainder of the string following that command is not executed.

If a new command string is input before the execution of the current string is complete, the current string is aborted and the remaining commands are cleared.

To cancel a currently executing string, send the termination command <CR> alone .

If a new command without Text File Data Upload (UU) is input while the execution of the current command stack, the remaining of the current command stack are cleared.

4.4 Status Returns

The completion message used in the Automatic Status is "R".

Example: R<CR>

4.5 Error Message

An error message is indicated by the letter E and followed by a two-character error code.

Example: EN₁N₂<CR>

The error message occurs when the given command cannot be processed.

4.6 Request Status Return

In response to a single request command, the status returns as a line of letters terminated by <CR> .

If multiple request commands are sent to the player within the same command string, the

player returns a separate status value upon completion of each command. A status value is a character string with a <CR> termination code.

Example: ?C?F<CR> ⇒ 02<CR>
 10260<CR>

When the request command is at the end of the command string, the R within the completion message is omitted.

Example: ST?F<CR> ⇒ 23005<CR> (completion omitted)

Example: ?FST<CR> ⇒ 23005<CR>R<CR> (not omitted)

4.7 Timing

The time it takes to receive a command and return a Status Value is defined as follows:

T1 represents the time from when the termination of the command string <CR> is received to the beginning of the execution of the command extension. The maximum is approximately 24ms.

T2 represents the time it takes to execute the command. Depending upon the command type and the player's condition, the minimum is 14ms.

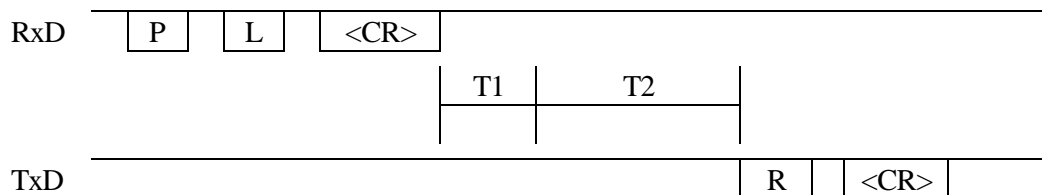

5. COMMAND DESCRIPTIONS

5.1 Open

Function : Door Opens (Tray Ejects)

Format : OP

Explanation : If the command is sent while the player is in the Park mode, the tray ejects and the player enters the Open mode. After the tray is ejected, the player returns the completed status message.

If the player is in any mode other than Open or Park, the disc stops, the player enters Open mode and the door opens.

If the player is already in Open mode, an error message is returned.

Execution:

Command String	Status Return	DVD-V7200
OP<CR>	R<CR>	Park mode to Open mode

5.2 Close

Function : Door is closed (Tray is closed)

Format : CO

Explanation : If the command is sent while the player door is open, the door is closed and the player enters the Park mode. After the door closes, the player returns the completed status message.

If the player is in any mode other than Open or if the player door is already closed, an error message is returned.

Execution :

Command String	Status Return	DVD-V7200
CO<CR>	R<CR>	Open mode to Park mode

5.3 Reject

Function : Disc rotation stops

Format : RJ

Explanation : If the command is sent while the player is in Random Access mode or Setup mode, the player enters Reject mode and the disc stops rotating. Once the disc

completely stops, the player enters Park mode and returns the completed status message.

If the command is sent while the player is in Park mode, the player enters Open mode and it opens the tray.

Execution :

Command String	Status Return	DVD-V7200
RJ<CR>	R<CR>	Random Access mode to Park mode

NOTE: Sending a second Eject command causes the player to open the tray.

5.4 Start

Function : Disc rotation starts

Format : SA

Explanation : If the command is sent while the player is in Open, Park or Reject mode, the player immediately enters Setup mode and the disc begins rotating. The player is ready for playback when the device reaches the beginning of the program (DVD, CD or VCD disc pauses or stills at the first track). The player returns the completed status when the disc pauses or stills.

If the player receives the command while playing a menu, the player returns an error message. However, if the disc program does not allow new commands once playback begins, the player ignores the command.

Execution :

Command String	Status Return	DVD-V7200
SA<CR>	R<CR>	Park mode to Pause mode
SA<CR>	E11<CR>	Open mode to Park mode <i>Error – No disc in tray</i>

5.5 Play

Function : Pictures and sound are reproduced (Option - Auto Stop)

Format : (Address)PL

Explanation : If the command is sent while the player is in Open, Park, or Reject mode, a DVD disc plays according to the menu selection or from the first title in case of no menu, and a CD/VCD disc plays from the first track. The player returns the completed status message after the Play mode begins.

If the player is in Random Access mode when the Play command is sent, the player enters Play mode and returns the completed status message. The Play mode is the only mode in which audio plays back simultaneously with video.

If an address is specified, an Auto Stop occurs on the selected sequence. The specified address is written as a Mark Frame or Mark Time and is compared with the current address. If the current address matches the specified address, the player enters Still mode and returns the completed status message.

The Auto Stop command is canceled if another command is sent before the player reaches the specified address. When this occurs, the player enters normal Play mode (the Stop Marker command is similar in function to Auto Stop).

If a Picture Stop code is detected before the player reaches the specified address, the player enters Still mode and returns an error message. However, if the disc program does not allow a stop, the player ignores the command and it may return the error message.

The available address modes are listed below:

Address Mode	DVD	LB-compatible DVD	CD	VCD
FR (frame)	X	X		
TM (time)	X	X	X	X
CH (chapter)	X	X		
TI (title)	X	X		
BK (block)			X	
IX (index)			X	X
TR (track)			X	X

Sometimes, an Auto Stop command within a VCD Block Number Address misses the specified address. Depending upon when the command is sent, a playback address may be missed by a maximum of ten-blocks.

Execution :

Command String	Status Return	DVD-V7200
PL<CR>	R<CR>	Park mode to Play mode
TM0325PL<CR>	<i>plays to 3 minutes 25 seconds</i> R<CR>	Pause mode to Play mode Play mode to Still mode

5.6 Pause

Function : Playback ceases temporarily

Format : PA

Explanation : If the command is sent while the player is in Random Access mode, the pause occurs at the current disc location. The player returns the completed status message immediately.

In Pause mode, Still and Video Squelch are ACTIVE. However, if the disc program does not allow a pause, the player ignores the command and returns the error message (E04).

Execution :

Command String	Status Return	DVD-V7200
PA<CR>	R<CR>	Play mode to Pause mode
PL<CR>	R<CR>	Return to Play mode

5.7 Still (DVD, VCD)

Function : Playback is stopped on a selected visual

Format : ST

Explanation : If the command is sent while the player is in Random Access mode, playback stops at the current disc position and the player enters Still mode. The player returns the completed status message immediately. However, if the disc program does not allow a pause, the player ignores the command and returns the error message (E04).

Execution :

Command String	Status Return	DVD-V7200
ST<CR>	R<CR>	Play mode to Still mode
PL<CR>	R<CR>	Return to Play mode

5.8 Step Forward (DVD, VCD)

5.9 Step Reverse (DVD)

Function : Playback is moved forward or in reverse by one frame

Format : SF (Step Forward)

SR (Step Reverse)

Explanation : If the command is sent while the player is in Random Access mode, the picture moves one frame forward or one frame in reverse. After the move is accomplished, the Player enters Still mode and returns the completed status message.

If the disc program does not allow a pause, the player ignores the command and

returns the error message (E04).

NOTE: One DVD Step Reverse is equal to between 15 and 30 frames

NOTE: A Video CD does not support the Step Reverse command

Execution :

Command String	Status Return	DVD-V7200
SF<CR>	<i>Moves 1 frame forward</i>	Play mode
	R<CR>	Still mode
SRSRSR<CR>	<i>Moves 3 frames backwards</i>	Play mode
	R<CR>	Still mode

5.10 Scan Forward,

5.11 Scan Reverse

5.12 Scan Stop

Function : Playback moves quickly forward or in reverse

Format : NF (Quick Forward scanning of the disc)

NR (Quick Reverse scanning of the disc)

NS (Stop Quick Forward scanning and return to normal playback)

Explanation : If the command is sent while the player is in Random Access mode, the screen proceeds forward (NF) or in reverse (NR) quickly. When scanning is finished, the player resumes the Random Access mode and returns the completed status message.

If the SCAN command is sent while the player is in fast forward or reverse playback, the player enters Scan mode.

Once the NS command is sent, the player resets to the normal Playback mode and returns the completed status message.

Execution :

Command String	Status Return	DVD-V7200
NF<CR> or NR<CR>	R<CR>	Play mode to Scan mode
NS<CR>	R<CR>	Return to Play mode

5.13 Multi-Speed Forward (DVD, VCD)

5.14 Multi-Speed Reverse (DVD)

Function : Playback occurs at the speed specified in the Speed Register
(Option - Auto Stop)

Format : (Address)MF (Multi-Speed Forward)
(Address)MR (Multi-Speed Reverse) (Address > 0)

Explanation : If the player is in Random Access mode when the command is executed, the player enters Multi-Speed mode and returns the completed status message immediately.

While in Multi-Speed mode, pictures are reproduced at the speed specified by the Speed Register. No audio tracks are played during Multi-Speed playback.

If an address is specified, an Auto Stop occurs on the selected sequence. The specified address is written as a Mark Frame or Mark Time and is compared with the current address. If the current address matches the specified address, the player enters Pause or Still mode and returns the completed status message. This command functions in a similar manner as the Stop Marker command.

If another command is issued before the player reaches the specified Address, the Auto Stop command is canceled and the player enters normal Multi-Speed mode. However, if the disc program does not allow a pause, the player ignores the command.

NOTE: There is no multi-speed reverse option without 1/2 speed in DVD. VCD offers 1/2 to 1/16 speed forward only.

Sometimes an Auto Stop command within some Multi-Speed commands misses the specific address. Depending upon when the command is sent, a playback address may be missed by a maximum of ten-blocks.

The available address modes in each disc type are listed below:

Address Mode	DVD	LB-compatible DVD	CD	VCD
FR (frame)	X	X		
TM (time)	X	X		X
CH (chapter)	X	X		
TI (title)				
BK (block)				
IX (index)				X
TR (track)				X

When playing back a VCD disc, sometimes an Auto Stop command within a Block Number address misses the specified address. Depending upon when the command is sent, a playback address may be missed by a maximum of ten-blocks.

Execution :

Command String	Status Return	DVD-V7200
MF<CR>	R<CR>	Play mode to Multi-Speed mode
TM0325MF<CR>	<i>plays to 3 minutes 25 seconds</i> R<CR>	Pause mode to Multi-Speed mode Pause mode

5.15 Speed (DVD, VCD)

Function : Specifies the speed for Multi-Speed playback

Format : Integer SP

Explanation : The command rewrites the contents of the Speed Register and returns the completed status message. The current mode of the player does not change.

The speed parameter indicates the number of fields per second. The range is 0 through 45 with a default value of 30 fields per seconds. The relationship between the integer, speed parameter and the actual speed of the player is as follows:

Integer	Speed Parameter	Speed
30	23~45	1/2
15	12~22	1/4
7	6~11	1/8
4	3~5	1/16
1	0~2	Step1

NOTE: Forward speeds greater than 1x are not available.

NOTE: There is no multi-speed reverse option without 1/2 speed in DVD. VCD offers 1/2 to 1/16 speed forward only.

Execution :

Command String	Status Return	DVD-V7200
4SPMF<CR>	R<CR>	Play mode to $\frac{1}{16}$ speed forward
30SP<CR>	R<CR>	Multi-Speed to $\frac{1}{2}$ Multi-Speed

5.16 Search

Function : Search to specified address

Format : Address SE

Explanation : The specified address is written into the Search Register in accordance with the current search address mode.

When the Search command is sent to the player, the specified address is compared with the current address. The pick-up is moved so that the difference becomes 0.

Upon reaching the specified address, the player enters the Pause mode in CD and the still mode in the others type discs and then returns the completed status message. If the player misses the specified address or can not find it out , an error message (E06 or E12) is returned. However, if the disc program does not allow a time or chapter search, the player ignores the command and an error message (E04) is returned. And also, if the disc program does not allow a pause, the player ignores the command.

The available address modes are listed below:

Address Mode	DVD	LB-compatible DVD	CD	VCD
FR (frame)	X	X		
TM (time)	X	X	X	X
CH (chapter)	X	X		
TI (title)	X	X		
BK (block)			X	
IX (index)			X	
TR (track)			X	X

Sometimes, an Auto Stop command within a VCD Block Number Address misses the specified address. Depending upon when the command is sent, a playback address may be missed by a maximum of ten-blocks.

Execution :

Command String	Status Return	DVD-V7200
FR4500SE<CR>	<i>Searches to frame 4500</i>	Play mode <i>Address Mode set = Frame</i> Still mode (DVD)
CH5SE<CR>	<i>Searches to chapter 5</i>	Play mode <i>Address mode set = Chapter</i> Still mode
TR2SE<CR>	<i>Searches to track 2</i>	Play mode <i>Address mode set = Track</i> Still mode (VCD)
IX902SE<CR>	<i>Searches to index 2, track 9</i>	Play mode <i>Address mode set = Index</i> Pause mode (CD)

5.17 Search & Play

Function : Searches to specified address and starts to play immediately in the Play mode.

Format : (Address) SL

Explanation : First of all, the specified address is written in suitable register of the player according to Address mode. Then it compared the address with the current address. The pick-up is moved so that the difference becomes 0.

The player plays a disc immediately from there after reached to the specific address. In case the player misses the address or can not find out, it returns error code (E06 or E12). And if Frame has been selected in Address Mode, the player does not execute the command.

The available address modes are listed below:

Address Mode	DVD	LB-compatible DVD	CD	VCD
FR (frame)				
TM (time)	X	X	X	X
CH (chapter)	X	X		
TI (title)	X	X		
BK (block)			X	
IX (index)			X	
TR (track)			X	X

Execution :

Command String	Status Return	DVD-V7200
CH5SL<CR>	R<CR>	Play mode Search Chapter 5 and Play mode.
TR2SL<CR>	R<CR>	Search Track 2 and Play mode.

5.18 Stop Marker

Function : Stop Marker is set to the specified address

Format : Address SM

Explanation : The specified address is written into the Mark-Frame Register or Mark-Chapter Register in accordance with the address specification flag. The player returns the completed status message immediately.

The Stop Marker is cleared when the player reaches the marked address via a Play command, a Multi-Speed operation or other action. The player enters the Pause mode (CD) or the Still mode (other disc types) with no messages returned. However, if the disc program does not allow a pause, the player ignores the command.

A Time Code or Chapter Number request notes whether or not the player reached a marked address. The Clear and Reject commands remove the marker.

The Stop Marker is the same in functionality as the Play or Multi-Speed Auto Stop commands. The primary difference is when the status message is returned. The Multi-Speed Auto Stop command returns the completed status message when the player reaches the marked address while the Stop Marker command returns the message as soon as the Stop Marker is set.

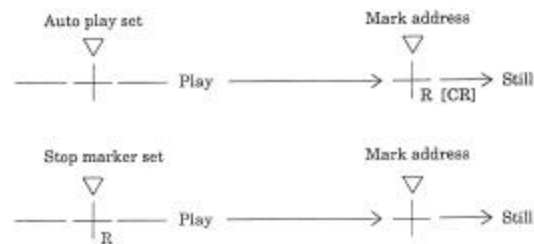

The available address modes are listed below:

Address Mode	DVD	LB-compatible DVD	CD	VCD
FR (frame)	X	X		
TM (time)	X	X	X	X
CH (chapter)	X	X		
TI (title)	X	X		
BK (block)			X	
IX (index)			X	X
TR (track)			X	X

Sometimes, an Auto Stop command within a VCD Block Number Address misses the specified address. Depending upon when the command is sent, a playback address may be missed by a maximum of a few ten-blocks.

Execution :

Command String	Status Return	DVD-V7200
TM0325SMPL<CR>	R<CR>	Pause mode to Play mode
MF<CR>	R<CR>	Multi-Speed mode
PL<CR>	R<CR>	Play mode <i>plays to 3 minutes 25 seconds</i> ⇒ <i>Still mode</i>

5.19 Lead-Out Symbol

Function : Lead-Out is set for an address

Format : LO Command <CR>

Explanation : This symbol can be used in place of a time code or a frame number as a target address for the Search or Auto Stop functions.

If the player has read the Table of Contents (TOC) from a disc, the Lead-Out Address or a Frame Number can be translated into the time of a lead-out.

The Lead-Out Search command on a CD or VCD disc stops the player at the end of a program area prior to the read-out area while the Lead-Out Search command on a DVD disc stops the player at the end of this title.

NOTE: On a VCD disc, the search address is set at several seconds prior to the lead-out point because the Lead-Out command requires the player to read video data in advance.

Execution :

Command String	Status Return	DVD-V7200
LOSE<CR>	R<CR>	Search mode to Still mode
?T<CR>	13642<CR>	<i>Time code in program end area</i>
LOPL<CR>	R<CR>	<i>Continue playing to lead-out and then return R<CR></i>

5.20 Clear

Function : Clears the digit buffer or mode

Format : CL

Explanation : The command clears the digit buffer content (input value) and returns the completed status message immediately.

The command releases the Auto Stop or the Stop Marker modes and returns the completed status message immediately. After the commands are released, the player begins normal playback. But the command does not release Multi Speed command.

The command releases the Repeat mode and execution of Command Stuck.

Execution :

Command String	Status Return	DVD-V7200
FR22000CL2300SE<CR>	<i>searches to frame 2300</i> R<CR>	Play mode Still mode
TM500SMPL<CR>	R<CR>	Play with Stop Marker
CL<CR>	R<CR>	<i>Stop Marker is released and player begins normal playback</i>

5.21 Frame (DVD)

Function : Address specification flag is set to frame

Format : FR

Explanation : Address assignment proceeds frame by frame. All subsequent addresses are handled as a frame number.

Execution :

Command String	Status Return	DVD-V7200
FR123450SE<CR>	<i>searches to frame 123450</i> R<CR>	Play mode to Search mode Still mode

[maximum number of frames is 7-digits in length (#####)]

5.22 Block Number (CD, VCD)

Function : Address specification flag is set to `block`

Format : `BK`

Explanation : Address assignment proceeds by block. All subsequent addresses are handled as a block number.

The Block refers to a physical block within a CD or a VCD. The physical block consists of 75 frames or blocks per second (different from traditional Video Frames).

But the player can not Block Number search with VCD disc.

Please refer to 8.10 Serial Use Address Flag.

Execution :

Command String	Status Return	DVD-V7200
<code>BK243020SE<CR></code>	<i>searches to 24 minutes, 30 seconds, 20 blocks</i>	Play mode to Search mode
	<code>R<CR></code>	Pause mode

5.23 Time (except disc which time code is not recorded)

Function : Address specification flag is set to `time`

Format : `TM`

Explanation : Address assignment proceeds by time code. All subsequent addresses are handled as a time code.

Please refer to 8.10 Serial Use Address Flag.

Execution :

Command String	Status Return	DVD-V7200
<code>TM12345SE<CR></code>	<i>searches to 123 minutes, 45 seconds</i>	Play mode to Search mode
	<code>R<CR></code>	Still mode

[maximum number of frames is 7-digits in length (#####)]

5.24 Chapter (DVD)

Function : Address flag is set to `chapter`

Format : `CH`

Explanation : Address assignment proceeds by chapter number. All subsequent addresses are handled as a chapter number. If the chapter number is not recorded on the disc, an error message is returned.

Please refer to 8.10 Serial Use Address Flag.

Execution :

Command String	Status Return	DVD-V7200
CH23SE<CR>	<i>searches to chapter 23</i>	Play mode to Search mode
	R<CR>	Still mode

5.25 Title (DVD)

Function : Address flag is set to `title`

Format : `TI`

Explanation : Address assignment proceeds by title. All subsequent addresses are handled as a title number.

Please refer to 8.10 Serial Use Address Flag.

Execution :

Command String	Status Return	DVD-V7200
TI5SE<CR>	<i>searches to Title 5</i>	Play mode to Search mode
	R<CR>	Still mode

5.26 Index (CD, VCD)

Function : Address flag is set to `index`

Format : `IX`

Explanation : Address assignment proceeds by index. All subsequent addresses are handled as an index number.

Please refer to 8.10 Serial Use Address Flag.

Execution :

Command String	Status Return	DVD-V7200
IX1204SE<CR>	<i>searches to index 4, track 12</i>	Play mode to Search mode
	R<CR>	Pause mode (CD)

5.27 TRACK (CD, VCD)

Function : Address flag is set to `track`

Format : TR

Explanation : Address assignment proceeds by track. All subsequent addresses are handled as a track number.

Please refer to 8.10 Serial Use Address Flag.

Execution :

Command String	Status Return	DVD-V7200
TR15SE<CR>	<i>searches to track 15</i> R<CR>	Play mode to Search mode Pause mode

5.28 Select Subtitle (DVD)

Function : Set Subtitle

Format : Integer SU

Explanation : The command sets the subtitle (caption). The player allows up to 32 subtitles for playback. If an unavailable track is selected, an error message (E06) is returned.

5.29 Select Audio (DVD)

Function : Select Audio

Format : Integer AU

Explanation : The command selects the audio channel (audio track). The player allows up to 8 audio channels for playback. If an unavailable track is selected, an error message (E06) is returned.

NOTE: If the setting is 0, the audio mute is ON.

5.30 Select Aspect

Format : Select Aspect Ratio

Function : Integer AP

Explanation : The command sets the Aspect Ratio for playback. The three ratios are Pan & Scan, Letter Box or Wide. If a disc does not offer video output options, an error message (E04) is returned.

Argument	Aspect Ratio (Video output)
1	Pan & Scan
2	Letter Box
3	Wide

5.31 Select Angle (DVD)

Function : Select Angle
 Format : Integer AG

Explanation : The command selects a viewing angle. The player allows up to 9 angles for playback. If an unavailable angle is selected, an error message (E04 or E06) is returned.

5.32 Select Parental-Level (DVD)

Function : Set Parental Level
 Format : Integer PT

Explanation : The command sets the parental level. The player allows up to 8 levels for playback. If an unavailable level is selected, an error message is returned.

5.33 Audio Control

Function : Control Audio Output
 Format : Integer AD

Explanation : The command allows changes to the audio output from the default value (7) then returns the completed status message. The player resets to the default value when the tray opens or when the power recycles.

NOTE: The player automatically resets the audio control to 3 (Audio 1),when it powers on.

The output channel assignment for each integer (argument) is listed below:

Argument	DVD ^{6c}	CD ¹	VCD
0	Off	Off	Off
1	Audio 2	---	---
2	Audio 3	---	---
3	Audio 1	---	---
4	Off	Off	Off
5	Audio 5	L	L
6	Audio 6	R	R
7	Audio 4	Stereo	Stereo

Execution :

Command String	Status Return	DVD-V7200
----------------	---------------	-----------

^c Includes LB compatible DVD

5AD<CR> R<CR> audio output = Stereo becomes
 audio output = Audio 5, L-ch

5.34 Video Control

Function : Video switch is turned ON / OFF

Format : Integer VD

Explanation : The command switches the video output on or off then returns the completed status message. The default value is 1 (video switch ON).

The squelch switch adjusts the video output when the video control is ON (during playback). If the player is in Park, Search or Pause mode, the video squelch is OFF and the color background is displayed.

When the Video Control is set to 0 (OFF), the video is squelched at all times.

Argument	Function	Video Switch
0	OFF	OFF
1	ON	ON

Execution :

Command String	Status Return	DVD-V7200
0VD<CR>	R<CR>	Video Switch = ON to Video Switch = OFF

5.35 Display Control

Function : Character display is turned ON / OFF

Format : Integer DS

Explanation : The player rewrites the Display Control Register (argument) then returns the completed status message. The default register value is 0 (display switched OFF). Arguments can display User's Area Characters, Title Number, Time Code, Chapter Number and Audio Output information.

NOTE: Argument 2 through 6 are available to display with Remote control unit. When DVD disc is played, the order of the display changing is 2, 6, 3, 4, 5 and OFF. In case when CD or VCD disc is played, the order is 2, 3, 4, OFF.

If Argument 1 is set through 232C command, the display changing is restricted with this command, so the display on the screen is not changed with Remote control unit.

Argument	Function
0	OFF

- 1 Displays user's area that is set by Register A
- 2 Title, chapter, track number, length of play, etc.
- 3 Play time or remain time of each chapter
- 4 Play time or remain time of each title
- 5 Audio and Subtitle information and Transfer rate etc
- 6 Add frame number to ARG.2 display

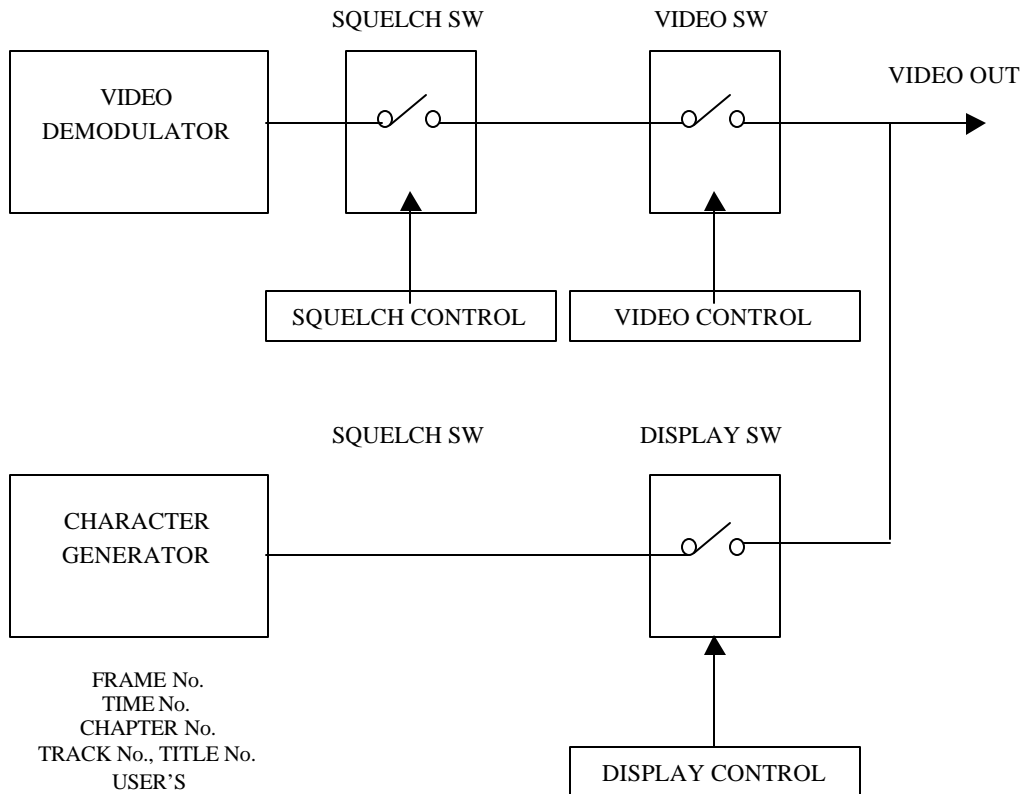

Execution :

Command String	Status Return	DVD-V7200
1DS<CR>	R<CR>	Display Switch = OFF to Display Switch = ON Display condition is set on Register A
3DS<CR>	R<CR>	Display condition = 3
DS<CR>	R<CR>	Display Switch = OFF

5.36 Key Lock

Function : The key lock switch is turned ON / OFF

Format : Integer KL

Explanation : The command enables/disables the remote control, the external switch including power control function, mouse and accessing to the front panel buttons. The default value is 0 (OFF) thus the player is unlocked.

If the key lock switch is set to 1, all buttons (front panel including power and remote control) external switch control including power control and mouse control are disabled. Use this setting for a PC-controlled player to lessen interference from outside sources such as remote control units.

If the key lock switch is set to 2, only the tray open button/key is disabled and the OP command no longer controls the tray. Thus, after powering off the player, the locked tray protects the disc from unauthorized personnel.

Argument	Function
0	Unlock
1	Locks all keys include power
2	Locks only tray open

Execution :

Command String	Status Return	DVD-V7200
1KL<CR>	R<CR>	Key Lock ON
OKL<CR>	R<CR>	Key Lock OFF (unlocked)
2KL<CR>	R<CR>	Tray Open Lock ON

5.37 Stack Group Set (DVD)

Function : Set Stack Group (Video Blackboard Stack or Barcode/Command Stack)

Format : Integer GP

Explanation : The command sets the stack group (Video Blackboard Stack or Barcode/Command Stack) for execution or access. It is added in conjunction with the BS (BARCODE/COMMAND STACK PLAY) or the VS (VIDEO BLACKBOARD DISPLAY) command (see following sections).

1 to 300, decimal system integer number is used in its argument.

5.38 Barcode /Command Stack Play (DVD)

Function : Execute Barcode/Command Stack from specific step

Format : Integer BS

Explanation : The command executes the Barcode/Command stack group from specific step after the GP command specifies the group number.

Error E06 is returned from a player in case BS command is issued with GP command that has unknown group number.

1 to 300, decimal system integer number is used in its argument.

Execution :

Command String	Status Return	DVD-V7200
25GP16BS<CR>	R<CR>	Execute from group 25/step 16

5.39 Video Blackboard Display (DVD)

Function : Execute Video Blackboard Display (displays a graphic or character)

Format : Integer VS

Explanation : The command presents the video blackboard display after the GP command specifies the group number. If the option is set to 0, the group graphics or characters are displayed on the screen. Settings between 1 and 300 cause the player to display the specified graphic or character only.

Error E06 is returned from a player in case BS command is issued with GP command that has unknown group number.

NOTE: Graphics or characters display automatically if the drawing/text is flagged with the Auto Display command.

Execution :

Command String	Status Return	DVD-V7200
25GPOVS<CR>	R<CR>	If Group 25 is available then it displays automatically
25GP32VS<CR>	R<CR>	Displays step 32 (graphic or character) from Group 25

5.40 Video Blackboard Clear

Function : Clears Video Blackboard Display

Format : CB

Explanation : The command clears graphics and characters that was displayed after GP or/and VS command with specific group and step.

In case any graphics and characters that is not displayed after issuing GP or/and VS command with specific group and step, the execution is canceled with this command.

Execution :

Command String	Status Return	DVD-V7200
CB<CR>	R<CR>	Clear the video blackboard display

5.41 Blackboard / Stack Data Upload

Function : Reads the data in the player : Blackboard data, Barcode data, Stack data

Format : BU

Explanation : The player sends the data to the computer after the command while it is Park mode.

The Communication flows as shown in below.

Flow of the communication :

(N=8420)

Computer	DVD-V7200
	---BU<CR>--->
	<---R<CR>-----
	<--1st byte data--
	<--2nd byte data--
	~
	<--(N-1)th byte data--
	<--Nth byte data<CR>--
	<---R<CR>-----

Format of the data :

BP	Contents	Numbers of bytes
0 - 1	(1) Total number of the transfer data (fixed number = 20e4H)	2 bytes
2 - 3	(2) The version of this data format (fixed value)	2 bytes
4 - 5	(3) Barcode #1 Search Pointer	2 bytes
6 - 7	Barcode #2 Search Pointer	2 bytes
~	~	~
600 - 601	Barcode #299 Search Pointer	2 bytes
602 - 603	Barcode #300 Search Pointer	2 bytes
604 - 605	(4) Number of Next Barcode Data	2 bytes
606 - 607	(5) Number of Next Barcode Group	2 bytes
608 - 609	(6) Blackboard #1 Search Pointer	2 bytes
610 - 611	Blackboard #2 Search Pointer	2 bytes
~	~	~
1204 - 1205	Blackboard #299 Search Pointer	2 bytes

1206 - 1207	Blackboard #300 Search Pointer	2 bytes
1208 - 1209	(7) Number of Next Blackboard Data	2 bytes
1210 - 1211	(8) Number of Next Blackboard Group	2 bytes
1212 - 1213	(9) Number of Next Blackboard Unit	2 bytes
1214 - 1215	(10) Next Data Address	2 bytes
1216 - 8415	(11) Barcode & Blackboard Data	7200 bytes
8416 - 8419	(12) Checksum	4 bytes

(1) Fixed data :

It indicates the total data bytes of this transfer with HEX digit.

20e4H = 8420

(2) Fixed data :

It indicates the version of this data format. It is (0000H) now. When it will be revised, it will be changed. Do not change its digits by users.

(3)

It indicates the head address of the #Nth Barcode / Command Stack data. The head address is relative address. Base address is (BP = 1216). (BP = 1216) is the head byte of Barcode & Blackboard Data in this data format.

(N = 1 ~ 300)

If the data of #Nths is not, it shows (ffffH).

(4)

It indicates the numbers of the registered Barcode / Command Stacks.

It is available from 0 to 299. And it shows with HEX digit.

(5)

It indicates the group number of the next Barcode / Command Stack.

It is available from 0 to 299. And it shows with HEX digit.

(6)

It indicates the head address of the #Nth Blackboard data. The head address is relative address. Base address is (BP = 1216). (BP = 1216) is the head byte of Barcode & Blackboard Data in this data format.

(N = 1 ~ 300)

If the data of #Nths is not, it shows (ffffH).

(7)

It indicates the numbers of the registered Picture / Text.

It is available from 0 to 299. And it shows with HEX digit.

(8)

It indicates the group number of the next Picture / Text.

It is available from 0 to 299. And it shows with HEX digit.

(9)

It indicates the umber of the next Picture / Text.

It is available from 0 to 299. And it shows with HEX digit.

(10)

It indicates the head address of the next Barcode / Command Stack data or Picture / Text data. The head address is relative address. Base address is (BP = 1216). (BP = 1216) is the head byte of Barcode & Blackboard Data in this data format.

(11)

It is the body of the data.

(12)

It is the checksum of the data. It indicates the result of added up from BP 0 to BP 8415. It shows with HEX (double word).

Format of Barcode / Command Stack data in the data :

The length of Barcode / Command Stack data is 16 bytes. This is a fixed length. Each byte is made up with (aH : Upper nibble) and one digit of the Barcode Command (Lower nibble). The Barcode Command length is available up to 16 - digits. If the command length is less than 16 - digits, it fills with (00H).

Example :

Segment Play Command : Title 02, from Frame 3600 to Frame 4800

> 4020036000048007

BP	Data	Explanations
1216 + BARCODE_SRP #n	a4H	
+ 1	a0H	
+ 2	a2H	
+ 3	a0H	
+ 4	a0H	
+ 5	a3H	
+ 6	a6H	
+ 7	a0H	
+ 8	a0H	
+ 9	a0H	
+ 10	a0H	
+ 11	a4H	
+ 12	a8H	
+ 13	a0H	
+ 14	a0H	
+ 15	a7H	

*BARCODE_SRP #n : Barcode #n Search Pointer

Outline of Barcode Command : Barcode Command has these formats as follows.

- DVD 4 digits command (Set the player, the video and the audio control)
- DVD 6 digits command (Set the attribute control)
- DVD 10 digits command (Chapter Search Command)
- DVD 12 digits command (Chapter Segment Play Command)
- DVD 14 digits command (Frame Search Command)
- DVD 16 digits command (Segment Play Command)
- LB compatible 4 digits command (Set the player, the video and the audio control)
- LB compatible 6 digits command (Chapter Search Command)
- LB compatible 8 digits command (Chapter Segment Play Command)
- LB compatible 10 digits command (Frame Search and Time Search Command)
- LB compatible 14 digits command (Frame segment Play and Time Segment Play)
- LB compatible 16 digits command (Special Effect Frame Segment Play)

NOTE: Follows two command functions in Barcode / Command Stack are not regulated in Barcode Format. So those are regulated as follows.

- 1) The mark of the end of group : The first byte is (ffH), the others are (00H).
- 2) REPEAT : (49a3H)

*Refer the details to the Barcode Format.

Format of Blackboard ; Picture data in the data :

The length of Blackboard ; Picture data is 24 bytes. This is a fixed length.

Example : Displays the picture compulsively.

Title 02, from Frame 3600 to Frame 4800. And GROUP 01, UNIT 03, Rectangle: the coordinates are (24, 36), (260, 200). Inside of the rectangle fills with blue.

BP	Data	Explanations
1216 + BARCODE_SRP #n	46H	Means "F", indicates the ID of Picture.
+ 1	04H	(1) Display mode ; This is a Forced display.
+ 2	02H	The starting Title number
+ 3	00H	The starting Address number (MSB)
+ 4	00H	The starting Address number
+ 5	0eH	The starting Address number
+ 6	10H	The starting Address number (LSB)

+ 7	02H	The ending Title number
+ 8	00H	The ending Address number (MSB)
+ 9	00H	The ending Address number
+ 10	12H	The ending Address number
+ 11	c0H	The ending Address number (LSB)
+ 12	00H	The number of Group
+ 13	01H	The number of Group
+ 14	00H	The number of Unit
+ 15	03H	The number of Unit
+ 16	71H	(2) The kind of Picture, color
+ 17	00H	The width of line
+ 18	00H	The starting point of Picture, X (MSB)
+ 19	18H	The starting point of Picture, X (LSB)
+ 20	01H	The ending point of Picture, X (MSB)
+ 21	04H	The ending point of Picture, X (LSB)
+ 22	24H	The ending point of Picture, Y
+ 23	c8H	The ending point of Picture, Y

*BARCODE_SRP #n : Barcode #n Search Pointer

(1) Display mode :

- 00H : The player do not anything.
- 01H : Pauses at the starting Address.
- 02H : Displays “*” while the player is in registered Address.
- 03H : Pauses and displays “*” while the player is in registered Address.
- 04H : Forced displays the picture.
- 05H : Pauses and forced displays the picture.
- 0dH : Pauses at the address just before registered Address.

(2) The kind of Picture, color :

- bit7, 6, 5 : The kind of Picture
 - 0 : There is no Picture.
 - 1 : Text
 - 2 : Line
 - 3 : Rectangle
 - 4 : Ellipse
 - 5 : Circle
- bit4, 3, 2 : The kind of color
 - 0 : White
 - 1 : Black

- 2 : Gray
- 3 : Red
- 4 : Blue
- 5 : Green
- 6 : Yellow
- 7 : Orange
- bit1, 0 : Paint mode
 - 0 : Only frame
 - 1 : The frame with filled color in inside it.
 - 2 : The frame with filled color in outside it.

Format of Blackboard ; Text data in the data :

The length of Blackboard ; Text data is a flexible length, from 22 bytes up to 341 bytes.

Example : Displays the text compulsively.

Title 02, from Frame 3600 to Frame 4800. And GROUP 01, UNIT 03, Text in 3rd line.

BP	Data	Explanations
1216 + BARCODE_SRP #n	54H	Means "T", indicates the ID of Picture.
+ 1	04H	(1) Display mode ; This is a Forced display.
+ 2	02H	The starting Title number
+ 3	00H	The starting Address number (MSB)
+ 4	00H	The starting Address number
+ 5	0eH	The starting Address number
+ 6	10H	The starting Address number (LSB)
+ 7	02H	The ending Title number
+ 8	00H	The ending Address number (MSB)
+ 9	00H	The ending Address number
+10	12H	The ending Address number
+11	c0H	The ending Address number (LSB)
+12	00H	The number of Group
+13	01H	The number of Group
+14	00H	The number of Unit
+15	03H	The number of Unit
+16	00H	The starting point of Text (MSB)
+17	40H	The starting point of Text (LSB)

+ 18	00H	The ending point of Text (MSB)
+ 19	44H	The ending point of Text (LSB)
+ 20	42H	Text data
~	~	~
+ m - 1	6bH	Text data
+ m	ffH	0xff

*BARCODE_SRP #n : Barcode #n Search Pointer

* 20 < m < 341

Text data includes the blanks. If your text has spaces, the player memorizes whole texts with spaces from the 1st character to the last character.

(1) Display mode :

- 00H : The player do not anything.
- 01H : Pauses at the starting Address.
- 02H : Displays “*” while the player is in registered Address.
- 03H : Pauses and displays “*” while the player is in registered Address.
- 04H : Forced displays the picture.
- 05H : Pauses and forced displays the picture.
- 0dH : Pauses at the address just before registered Address.

Execution :

Command String	Status Return	DVD-V7200
BU<CR>		Park mode
	R<CR>	Receives the command and starts
	20e40010 . . .	the transfer of the data, 8420 bytes.
	. 026743<CR>	It ends with <CR>.
	R<CR>	

5.42 Blackboard / Stack Data Download

Function : Sends the data to the player : Blackboard data, Barcode data, Stack data

Format : BD

Explanation : The Blackboard / Stack data is written in the player from the computer after received the command while it is Park mode.

Refer to the descriptions of Blackboard / Stack Data Upload.

The Communication flows as follows.

Flow of the communication :

(N=8420)

Computer	DVD-V7200
	---BU<CR>--->
	<---R<CR>-----
	--1st byte data-->
	--2nd byte data-->
	~
	--(N-1)th byte data-->
	--Nth byte data<CR>--->
	<---R<CR>-----

Execution :

Command String	Status Return	DVD-V7200
BD<CR>		Park mode
	R<CR>	Receives the command and starts the receiving data, 8420 bytes. It ends with <CR>.
20e40010...0 26743<CR>	R<CR>	

5.43 Weekly Timer Data Upload

Function : Reads the data of the Weekly Timer in the player.

Format : WU

Explanation : The player sends the data to the computer after the command while it is Park mode.

The Communication flows as follows.

Flow of the communication :

Computer	DVD-V7200
	---WU<CR>--->
	<---R<CR>-----
	<--1st byte data--
	<--2nd byte data--
	~
	<--75th byte data--

 <---76th byte data<CR>--

 <---R<CR>----

Format of the data :

BP	Contents	Numbers of bytes
0 - 1	(1) Total number of the transfer data. (fixed number = 004cH)	2 bytes
2	(2) Set the mode on Monday	1 bytes
3	(3) Set the hour of Turning on on Mon.	1 bytes
4	Set the minute of Turning on on Mon.	1 bytes
5	(4) Set the hour of Turning off on Mon.	1 bytes
6	Set the minute of Turning off on Mon.	1 bytes
7	(5) 00 (fixed data = 00H)	1 bytes
8	(6) The upper digit of Title number or Stack group number that is searched on Mon. Set it with BCD.	1 bytes
9	The lower digit of Title number or Stack group number that is searched on Mon. Set it with BCD.	1 bytes
10	(7) The upper digit of Chapter number that is searched on Mon. Set it with BCD.	1 bytes
11	The lower digit of Chapter number that is searched on Mon. Set it with BCD.	1 bytes
12	(2) Set the mode on Tuesday.	1 bytes
~	(3) - (7) ~	~
22	(2) Set the mode on Wednesday.	1 bytes
~	(3) - (7) ~	~
32	(2) Set the mode on Thursday.	1 bytes
~	(3) - (7) ~	~
42	(2) Set the mode on Friday.	1 bytes
~	(3) - (7) ~	~
52	(2) Set the mode on Saturday.	1 bytes
~	(3) - (7) ~	~
62	(2) Set the mode on Sunday.	1 bytes
63	(3) Set the hour of Turning on on Sun.	1 bytes
64	Set the minute of Turning on on Sun.	1 bytes
65	(4) Set the hour of Turning off on Sun.	1 bytes
66	Set the minute of Turning off on Sun.	1 bytes

67	(5) 00 (fixed data = 00H)	1 bytes
68	(6) The upper digit of Title number or Stack group number that is searched on Sun. Set it with BCD.	1 bytes
69	The lower digit of Title number or Stack group number that is searched on Sun. Set it with BCD.	1 bytes
70	(7) The upper digit of Chapter number that is searched on Sun. Set it with BCD.	1 bytes
71	The lower digit of Chapter number that is searched on Sun. Set it with BCD.	1 bytes
72 - 75	Checksum	4 bytes

(1) Fixed data :

It indicates the total data bytes of this transfer with HEX digit.

004cH = 76

(2)

The number that indicates the player mode when the player turns on is written in here. It specifies the player mode as follows.

Upper nibble of it

4 : The player will seek the Title and Chapter that is written in the data.

8 : The player will execute the Stack that is specified in the data.

Lower nibble of it (This indicates the day)

0 : Monday

1 : Tuesday

2 : Wednesday

3 : Thursday

4 : Friday

5 : Saturday

6 : Sunday

(3)

It indicates the hour that the player power will be turned on. Basically, the hour is used with the minute and is expressed with 00 through 23. The ffH means the hour is not written in it.

(4)

It indicates the minute of the player power will be turned on. Basically, the minute is used with the hour and is expressed with 00 through 59. The ffH means the minute is not written in it.

(5) Fixed data :

00H

(6)

It indicates the upper and lower digit of Title number or Stack group number according to the player mode that is written in it. (Refer to (2)) When the upper nibble of the mode is 4, it indicates Title number. When 8, it indicates Stack group number. It is shown with BCD.

(7)

It indicates the upper and lower digit of Chapter number or Stack group number according to the player mode that is written in it. (Refer to (2)) When the upper nibble of the mode is 4, it indicates Chapter number. When 8, it fixed 00H (upper) and 01H (lower). It is shown with BCD.

(8)

It is the checksum of the data. It indicates the result of added up from BP 0 to BP 71. It is shown with HEX (double word).

Example :

Monday, Turning on at 8:30, and turning off at 17:20. Seek Title 20th Chapter 5th.
 Tuesday, Turning on at 9:30 only. Execute Stack group 123.

BP	Data	Explanations
0	00H	
1	4cH	
2	40H	The mode of Monday
3	08H	8 o'clock (Hour of turning on)
4	30H	30 minutes (Minute of turning on)
5	17H	17 o'clock (Hour of turning off)
6	20H	20 minutes (Minute of turning on)
7	00H	Fixed data
8	00H	The upper digit of Title number
9	20H	The lower digit of Title number
10	00H	The upper digit of Chapter number
11	05H	The lower digit of Chapter number
12	81H	The mode of Tuesday
13	09H	9 o'clock
14	30H	30 minutes
15	ffH	

16	ffH	
17	00H	Fixed data
18	01H	The upper digit of Stack group
19	23H	The lower digit of Stack group
20	00H	Fixed data
21	01H	Fixed data
22		~
~		~

Execution :

Command String	Status Return	DVD-V7200
WU<CR>		Park mode
	R<CR>	Receives the command and starts
	004c4008 . . .	the transfer of the data, 76 bytes. It
	.001ab6<CR>	ends with <CR>.
	R<CR>	

5.44 Weekly Timer Data Download

Function : Sends the data of the Weekly Timer to the player.

Format : WD

Explanation : The Weekly Timer data is written in the player from the computer after received the command while it is Park mode.

Refer to the descriptions of Weekly Timer Data Upload.

The Communication flows as follows.

Flow of the communication :

Computer	DVD-V7200
	---WD<CR>--->
	<---R<CR>-----
	--1st byte data-->
	--2nd byte data-->
	~
	--75th byte data-->
	--76th byte data<CR>-->
	<---R<CR>-----

Execution :

Command String	Status Return	DVD-V7200
WD<CR>		Park mode
	R<CR>	Receives the command and starts the transfer of the data, 76 bytes. It ends with <CR>.
004c4008....0 01ab6<CR>		
	R<CR>	

5.45 Text File Data Upload

Function : Reads the data of the Text File data from the player.

Format : UU

Explanation : The Weekly Timer data is written in the player from the computer after received the command while it is Park mode. It ends with <EOF(End Of File: 1aH)>

Unless the player displays the Text File, it returns Error code.

Execution :

Command String	Status Return	DVD-V7200
UU<CR>		While Text File is been displaying
	R<CR>	Receives the command and starts the transfer of all the Text File data from the player. It ends with <EOF>.
	PIONEER ANNOUNCED NEW INDUSTRIAL DVD-VIDEO PLAYER	
	On February 2, 1999, Pioneer New Media Technologies, Inc. unveiled its or registered trademarks of their respective owners. <EOF>	
	R<CR>	

6. CURRENT PLAYER CONDITION REQUEST DESCRIPTIONS

6.1 P-Block Number Request

Function : The command returns information for the following volume groups:
 DVD – Title Numbers, Chapter Numbers, Time
 LB Compatible DVD (CAV) – Title, Chapter, CAV Frame Numbers
 LB compatible DVD (CLV) – Title, Chapter, CLV Time
 CD/VCD – Track Numbers, Index Numbers, Time, Block Numbers

Format : ?A

Explanation : The P-Block Number Request command sent to a DVD disc groups title numbers, chapter numbers and time code information together and returns the data in a single report. When the command is sent to a LB-compatible DVD disc, the player returns title numbers, chapter numbers and CAV frame numbers or CLV time codes. A request sent to a CD/VCD disc returns track numbers, index numbers, block numbers and time codes.

The continuous frame count information may be missing from a report if the P-Block Number Request is sent while the player is in normal playback mode. The player does not update frame counts while processing this command. Rather than returning an incorrect frame count, the player does not provide the data.

If the player is in Random Access Mode or is reading the lead-in/lead out area of the disc, the report contains correct values.

Execution :

Command String	Status Return	DVD-V7200
?A<CR>	1201033545<CR>	Play mode (CD) <i>track 12, index 1, 3 minutes, 35 seconds 45 blocks</i>
?A<CR>	0135001247<CR>	Play mode (DVD) <i>title 1, chapter 35, 12 minutes, 47 seconds</i>
?A<CR>	0401002552<CR>	<i>title 4, chapter 1, frame 2552</i>

6.2 Title/Track Number Request

Function : Returns the current title/track number

DVD : Title

CD/VCD : Track

Format : ?R

Explanation : The player returns the contents of the Title/Track Number Register. The track number is a 2-digit integer. Correct values will not be shown unless the player is in Random Access Mode or is playing the lead-in/out area of the disc.

Execution :

Command String	Status Return	DVD-V7200
?R<CR>	12<CR>	Play mode (CD) <i>Player plays Track 12</i>

6.3 Chapter Number Request (DVD)

Function : Returns the current chapter number

Format : ?C

Explanation : The player returns the contents of the Chapter Number Register. The chapter number is a 2-digit integer. If a disc does not have any chapter numbers, the player returns an error message (E04). Correct values will not be shown unless the player is in Random Access Mode or is playing the lead-in/out area of the disc.

Execution :

Command String	Status Return	DVD-V7200
?C<CR>	12<CR>	Play mode (CD) <i>Player plays Chapter 12</i>

6.4 Time Code Request

Function : Returns the current Time Code

Format : ?T

Explanation : The player returns the contents of the Current Time/Frame Register.

If a DVD disc is playing, a 3-digit number is assigned for minutes and a 2-digit number is assigned for seconds.

If a CD or VCD disc is playing, a 1-digit number is assigned for hours (fixed 0), a 2-digit number is assigned for minutes and a 2-digit number is assigned for seconds.

If the player is in Random Access mode or if the player is reading the lead-in/lead-out area of the disc, the value returned is current and correct.

If a disc does not have any time information, the player returns error message (E04).

If a disc time code cannot be read correctly, the player retains the previous time code.

Execution :

Command String	Status Return	DVD-V7200
		Play mode (VCD)
?T<CR>	03213<CR>	<i>32 minutes, 13 seconds</i>
?T<CR>	11742<CR>	<i>117 minutes, 42 seconds</i>

6.5 Index Number Request (CD, VCD)

Function : Returns the current Index number

Format : ?I

Explanation : The player returns the current index number as a 4-digit integer. Correct values will not be shown unless the player is in Random Access Mode or is reading the lead-in/lead-out area of the disc.

Execution :

Command String	Status Return	DVD-V7200
?I<CR>	0102<CR>	Play mode <i>track 1, index 2</i>

6.6 Frame Number Request (DVD)

Function : Returns the current frame number

Format : ?F

Explanation : The player returns the contents of the Current Frame Register.

The player may experience a conflict between the command receiving/handling and the frame number updating. Thus, continuous frame numbers may not be available when the system is in Playback mode.

If the command is sent to a disc that does not include frame numbers, the player returns an error message (E04).

Current values will not be shown unless the player is in Random Access mode or is reading the lead-in/lead-out area of the disc.

If a disc frame number cannot be read correctly, the player retains the previous value.

Execution :

Command String	Status Return	DVD-V7200
?F<CR>	0002047<CR>	Play mode <i>frame 2047</i>
?F<CR>	0095010<CR>	Play mode <i>frame 950107</i>

6.7 Block Number Request (CD, VCD)

Function : Returns the current block number

Format : ?B

Explanation : The player returns the value of the current block number as a 7-digit integer. Current values will not be shown unless the player is in Random Access mode or is reading the lead-in/lead-out area of the disc.

If a block number cannot be read correctly, the player retains the previous value.

Execution :

Command String	Status Return	DVD-V7200
?B<CR>	0115310<CR>	Play mode <i>11 minutes, 53 seconds, 10 blocks</i>

6.8 Total Frame Request (DVD)

Function : Returns the current total frame number of the title

Format : ?Y

Explanation : The player returns the current total frame number of the title.

Execution :

Command String	Status Return	DVD-V7200
?Y<CR>	0124832<CR>	Play mode <i>frame 124832</i>

6.9 TOC Information Request (CD/VCD)

Function : Returns the Table of Contents (TOC) information

Format : ?Q

Explanation : The player returns the track number of the first track, the track number of the last track and the absolute time of starting lead-out.

Status information is returned in the following format:

C₁C₂C₃C₄C₅C₆C₇C₈C₉C₁₀<CR>

C ₁ C ₂	first track number
C ₃ C ₄	last track number
C ₅ C ₆ C ₇ C ₈ C ₉ C ₁₀	absolute time of starting lead-out

Execution :

Command String	Status Return	DVD-V7200
?Q<CR>	0109665544<CR>	Play mode <i>first track is 1, last track is 9, lead-out time is 66 minutes, 55 seconds, 44 blocks</i>

6.10 Disc Region Code Request

Function : Returns the region code of the disc

Format : ?G

Explanation : The player returns the approved region code(s) designated by the disc.

Each bit indicates each region in a returned byte from a player. Bit 0 (LSB) indicates region 1, bit 1 indicates region 2....., bit 5 indicates region 6. 0 shows the disc has its playability in its region.

Execution :

Command String	Status Return	DVD-V7200
?G<CR>	F9<CR> (=11111001B)	Play mode <i>Region code 2 and 3</i>
?G<CR>	C0<CR> (=11000000B)	Play mode <i>Region code 1, 2, 3, 4, 5 and 6 (ALL)</i>

6.11 DVD Disc Status Request

Function : Returns the attributes of the DVD disc being played

Format : ?V

Explanation : The player returns the attributes of the DVD disc. If the disc is other than DVD, the player returns an error message (E04).

Status information is returned in the following format:

C₁C₂C₃C₄C₅<CR>

C ₁	Disc Mount	0 = No	1 = Yes	X = Unknown
----------------	------------	--------	---------	-------------

C ₂	Layer Structure	0 = Single	1 = Dual	X = Unknown
C ₃	Path Type	0 = Parallel	1 = Opposite	X = Unknown
C ₄	Chapter Search	0 = Disable	1 = Available	X = Unknown
C ₅	Time Search	0 = Disable	1 = Available	X = Unknown

Execution :

Command String	Status Return	DVD-V7200
?V<CR>	0XXXX<CR>	<i>Disc is not mounted</i>
?V<CR>	10010<CR>	<i>available Chapter search but disable Time search</i>
?V<CR>	E04<CR>	<i>Error – except DVD disc loaded</i>

6.12 LD Disc Status Request (LB-compatible DVD)

Function : Returns the attributes of the LD disc being played

Format : ?D

Explanation : The player returns the attributes of the LD disc. If the disc is other than LD or LB-compatible DVD, the player returns an error message (E04).

Status information is returned in the following format:

C₁C₂C₃C₄C₅<CR>

C ₁	Disc Mount	0 = No	1 = Yes	X = Unknown
C ₂	CAV/CVL	0 = CAV	1 = CLV	X = Unknown
C ₃	Disc Size	0 (fixed)		X = Unknown
C ₄	Disc Side	0 (fixed)		X = Unknown
C ₅	Chapter Code	0 = No	1 = Yes	X = Unknown

Execution :

Command String	Status Return	DVD-V7200
?D<CR>	0XXXX<CR>	<i>Disc is not mounted</i>
?D<CR>	11001<CR>	<i>CLV disc with chapter code</i>
?D<CR>	E04<CR>	<i>Error - CD or VCD disc loaded</i>

6.13 CD Disc Status Request

Function : Returns the attributes of the CD disc being played

Format : ?K

Explanation : The player returns the attributes of the CD disc. If the disc is other than CD, the player returns an error message (E04).

Status information is returned in the following format:

C₁C₂C₃C₄C₅C₆C₇C₈<CR>

C ₁	Disc Mount	0 = No	1 = Yes	X = Unknown
C ₂	Not Used	X (fixed)		
C ₃	Not Used	X (fixed)		
C ₄	Not Used	X (fixed)		
C ₅	Not Used	X (fixed)		
C ₆	VCD	0 = No	1 = Yes	X = Unknown
C ₇	Reserved	X (fixed)		
C ₈	Reserved	X (fixed)		

Execution :

Command String	Status Return	DVD-V7200
?K<CR>	0XXXXXXXX<CR>	<i>Disc is not mounted</i>
?K<CR>	1XX1XXXX<CR>	<i>CDV</i>
?K<CR>	E04<CR>	<i>DVD</i>

6.14 Register A Set

Function : The current setting of Register A is rewritten

Format : Integer RA

Explanation : The command rewrites detailed display attributes into Register A. The player offers three settings:

- Frame Number/Time code
- Title, Chapter Number/Track Number
- User's Area

Note: In case of DVD disc playback and selecting Frame Number/Time code, Frame Number is usually displayed on the screen. But in case of DVD disc and selecting both Frame Number/Time code and Time code(DVD), Time code is displayed. In case of CD or VCD disc playback, Time code is displayed both Frame Number/Time code or Time code selection.

The available display combinations are listed in the following table (Default value is 3):

Argument	Function	User's	T&CH / Track	Frame / Time	Time (DVD)
0	Display OFF	0	0	0	0
1	Frame Number (DVD)/Time Code (CD)	0	0	1	0
2	Title & Chapter Number/Track Number	0	1	0	0
3 (default)	Frame Number (DVD) / Time Code	0	1	1	0

	(CD, VCD) + Title, Chapter, Frame/Track, Time				
4	User's area	1	0	0	0
5	User's area + Argument 1	1	0	1	0
6	User's area + Argument 2	1	1	0	0
7	User's area + Argument 3	1	1	1	0
11	Time Code (DVD, CD, VCD)	0	0	1	1
13	Time Code (DVD, CD, VCD) + Title & Chapter Number/Track Number + User's Area	0	1	1	1
15	Time Code (DVD, CD, VCD) + User's Area	1	0	1	1
17	Time Code (DVD, CD, VCD) + Title & Chapter Number/Track Number + User's Area	1	1	1	1

The Display Control command turns ON and OFF the character displays. And this Register A Set command specifies what is displayed on the screen.

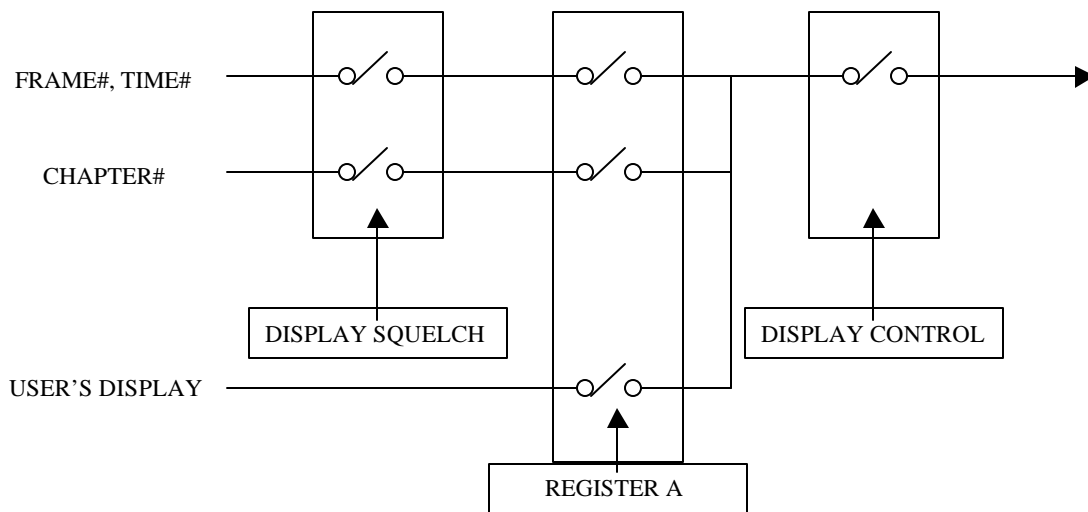

The screen display positions are pictured below.

	Title/Chapter(Track)					Time (Frame)															
Line 0	v	v	v	v	v	v	v	v	v	v	v	v	v	v	v	v	v	v	v	v	v
Line 1	v	v	v	v	v	v	v	v	v	v	v	v	v	v	v	v	v	v	v	v	v
2	v	v	v	v	v	v	v	v	v	v	v	v	v	v	v	v	v	v	v	v	v

3	v	v	v	v	v	v	v	v	v	v	v	v	v	v	v	v	v	v	v
4	v	v	v	v	v	v	v	v	v	v	v	v	v	v	v	v	v	v	v
5	v	v	v	v	v	v	v	v	v	v	v	v	v	v	v	v	v	v	v
6	v	v	v	v	v	v	v	v	v	v	v	v	v	v	v	v	v	v	v
7	v	v	v	v	v	v	v	v	v	v	v	v	v	v	v	v	v	v	v
8	v	v	v	v	v	v	v	v	v	v	v	v	v	v	v	v	v	v	v
9	v	v	v	v	v	v	v	v	v	v	v	v	v	v	v	v	v	v	v

Line 0 displays the Time Code/Frame Number and/or Title/Chapter/Track Number.

The user's area has lines numbered from 0 to 9, a total of 10 available lines. If line 0 is designated to show system information, all following lines are not displayed.

The player allows up to 320 characters (32 characters per each line with 10 lines available) to be displayed. Follow the instructions below to create a User's Display:

1. Select User's Display in Register A
2. Set the display data using Print Character command
3. Turn display switch ON (Set Display Control command)

Execution :

Command String	Status Return	DVD-V7200
1DS<CR>	R<CR>	Display Off to Display On
1RA<CR>	R<CR>	<i>Only frame number is displayed</i>

6.15 Register B Set

Function : The current setting of Register B is rewritten

Format : Integer RB

Explanation : The command rewrites Audio and Video Squelch Switch attributes into Register B. The squelch switch is controlled automatically in accordance with operating mode of the player. However, by rewriting the contents of Register B, it is possible to invalidate the squelch switch except the squelch during search.

Argument	Function		
0 (default)	Normal		
64	Audio SQ invalid		
128	Video SQ invalid		
192	VD/AD SQ invalid		

6.16 Register D Set

Function : The current setting of Register D is rewritten

Format : Integer RD

Explanation : Register D contains the termination setting of the serial communication (RS232). There are two choice: "CR", "CR + LF". The default of the Register D is 0.

Argument	Function
0 (default)	CR
64	CR + LF

6.17 Print Character

Function : Characters are written into the User's Display Area
(Not to be issued simultaneously with other commands)

Format : Integer PR <CR>
Character string <CR>

Explanation : The command writes a character string for one line into the User Display Area (turn on the User Display Specification in Register A).

Follow the instructions listed below to create printed characters.

1. Specify the line number using an integer in the range 0 ~ 9
2. Enter the command character PR
3. Enter the terminate code <CR>
4. Specify the character string to enter in the next command string
(enter a character string up to 32 characters in length)

Available characters are shown in the table below (from 20h through 9Fh):

	0	1	2	3	4	5	6	7	8	9	A	B	C	D	E	F
2		!	“	#	\$	%	&	'	()	*	+	,	-	.	/
3	0	1	2	3	4	5	6	7	8	9	:	;	<	=	>	?
4	@	A	B	C	D	E	F	G	H	I	J	K	L	M	N	O
5	P	Q	R	S	T	U	V	W	X	Y	Z	[¥]	^	_
6	'	a	b	c	d	e	f	g	h	i	j	k	L	m	n	o
7	p	q	r	s	t	u	v	w	x	y	z	{		}	~	*1
C	À	Á	Â	Ã	Ä	Å	Æ	Ç	È	É	Ê	Ë	Ì	Í	Î	Ï
D	Ð	Ñ	Ò	Ó	Ô	Õ	Ö	×	Ø	Ù	Ú	Û	Ü	Ý	Þ	ß
E	à	á	â	ã	ä	å	æ	ç	è	é	ê	ë	ì	í	î	ï
F	ð	ñ	ò	ó	ô	õ	ö	÷	ø	ù	ú	û	ü	ý	þ	ÿ

*1 can not be used

Execution :

Command String	Status Return	DVD-V7200
4RA1DS<CR>	R<CR>	<i>Register A and Display control set</i>
4PR<CR>	R<CR>	<i>Select Line 4</i>
*** DVD-V700 ***<CR>	R<CR>	<i>Displays the characters like this ***DVD-V700***</i>

6.18 Clear Screen

Function : Clears the characters shown in the User Display Area

Format : CS

Explanation : The player clears all characters from the User Display area. To clear only a particular line, use the PR command to overwrite the line with spaces.

Execution :

Command String	Status Return	DVD-V7200
CS<CR>	R<CR>	<i>All lines are cleared</i>
3PR<CR>	R<CR>	<i>Select line 3</i>
HELLO! <CR>	R<CR>	<i>Write letters on line 3, HELLO!</i>
3PR<CR>	R<CR>	<i>Select line 3</i>
<CR>	R<CR>	<i>Clear only line 3</i>

6.19 Real Time Clock Set

Function : Sets the real time clock

(Not to be issued simultaneously with other commands)

Format : WW <CR>

7 Bytes integer <CR> (=YYMMDDWWHHMMSS<CR>)

Explanation : The real time clock may be set using the following format:

YY	the last two digits of year
MM	month
DD	date
WW	day, 00 means Monday, 06 means Sunday
HH	hour 24-hour format
MM	minute
SS	second

NOTE: Input the 7-Bytes integer as a single entry. If an integer is less than 7-Bytes in length, the player returns an error message.

Execution :

Command String	Status Return	DVD-V7200
WW<CR>	R<CR>	<i>Set Real Time Clock setting mode</i>
98040102083025<CR>	R<CR>	<i>Sets Wednesday, April First, 8:30:25 AM, 1998</i>

6.20 Advanced Feature Menu Set

Function : The current setting of Industrial Player Menu is rewritten

Format : Integer MS

Explanation : The command rewrites the setting of Industrial Player Menu as like follows. Basically, the setting is expressed with some integer value. The value is made up with the sum of each argument you want. The default is 0 when the player was shipped. The player returns an error code if the command is issued when the player is showing Industrial Player Menu on the screen.

The current setting is gotten with the Advanced Feature Menu Request command (?S).

Argument	Function	Description	
		0	1
1	WEEKLY TIMER	OFF	ON
2	POWER ON START	OFF	ON
4	TITLE PLAY MODE	SINGLE	ALL
8	REPEAT MODE	(0) OFF, (8) CHAPTER	
16		(16) TITLE, (24) DISC *1)	
32	BAUD RATE	4800bps	9600bps
64	TRAY LOCK	OFF	ON
128	BLACKBOARD LOCK	OFF	ON

256	STILL MODE	FRAME	FIELD
512	Dynamic Range COMPression	[9 option, OFF or 1 to 8]	
1024		(0) OFF, (512) 1,	
2048		(1024) 2, (2048) 4,	
4096		~, (4096) 8	
8192	MARK FRAME SQUELCH	OFF	ON
16384	SQUELCH DURING SEARCH	ON	OFF
32768	SYNC OUT (DURING SQuelch)	OFF	ON
65536	STACK MODE OSD	ON	OFF
131072	SETUP LOCK (MOUSE)	OFF	ON
262144	KEYBOARD *2)	JAPANESE	ENGLISH

*1): (TitlePlayMode +1)

*2): This function is available to Japan model only.

The setting value is calculated as follows.

The value = $1 * (0 \text{ or } 1) + 2 * (0 \text{ or } 1) + 4 * (0 \text{ or } 1) + (0 \text{ or } 8 \text{ or } 16 \text{ or } 24) + 32 * (0 \text{ or } 1) + 64 * (0 \text{ or } 1) + 128 * (0 \text{ or } 1) + 256 * (0 \text{ or } 1) + 512 * (0 \text{ or } 1 \text{ to } 8) + 8192 * (0 \text{ or } 1) + 16384 * (0 \text{ or } 1) + 32768 * (0 \text{ or } 1) + 65536 * (0 \text{ or } 1) + 131072 * (0 \text{ or } 1) + 262144 * (0 \text{ or } 1)$

Execution :

Command String	Status Return	DVD-V7200
112MS<CR>	R<CR> (The return rate is 9600bps)	<i>Title repeat mode (16)</i> <i>Baud rate is 9600bps (32)</i> <i>Tray lock on (64)</i>

6.21 Communication Control Set

Function : Selects the communication mode

Format : Integer CM

Explanation : The command rewrites the contents of the Communication Control Register (CCR).

The CCR default value is set to Mode 3 (ON); however, the CCR Automatic Status may be switched OFF. Use the command to toggle to the required mode.

Argument	Mode	Auto Status
2	Mode-2	OFF
3	Mode-3	ON

Execution :

Command String	Status Return	DVD-V7200
2CM<CR>	R<CR>	CCR = 3 (<i>Default Communication Mode</i>) to CCR = 2 (<i>Communication Mode-2</i>)

6.22 Player Active Mode Request

Function : Returns the current activity mode of the player

Format : ?P

Explanation : The command confirms whether or not the player has been started and placed into the Random Access mode and so on. The player returns an Active mode classification from the table below.

P00	Open	P05	Still
P01	Park	P06	Pause
P02	Setup	P07	Search
P03	Unload	P08	Scan
P04	Play	P09	Multi-speed

The following table provides fuller explanations for each Active mode:

P00 (Open)	Disc tray is open
P01 (Park)	Disc rotation is stopped
P02 (Setup)	Preparation is being made for playback
P03 (Unload)	Disc rotation stops and disc tray opens
P04 (Play)	Audio and video are played at normal speed
P05 (Still)	Playback stops with video held on screen
P06 (Pause)	Playback stops and video is erased from screen
P07 (Search)	A specified address is searched for, a multi-track jump is in progress, or a search for user's code is in progress
P08 (Scan)	Fast forward is in progress
P09 (Multi-speed)	Playback occurs at any one of several speeds

Execution :

Command String	Status Return	DVD-V7200
?P<CR>	P04<CR>	Play mode
ST<CR>	R<CR>	Still mode
?P<CR>	P05<CR>	Play mode

6.23 Player Model Name Request

Function : Returns player model name

Format : ?X

Explanation : The command returns the player's name as P1551XX where P1551 is the name of series and XX is a 2-digit serial code (not product serial number).

Execution :

Command String	Status Return	DVD-V7200
?X<CR>	P155102<CR>	<i>Series name P1551 and serial code 02</i>

6.24 Real Time Clock Request

Function : Returns the Real Time Clock

Format : ?W

Explanation : The command returns the Real clock time in the following format:

YY	the last two digits of year
MM	month
DD	date
WW	day, 00 means Monday, 06 means Sunday
HH	hour 24-hour format
MM	minute
SS	second

Execution :

Command String	Status Return	DVD-V7200
?W<CR>	98061002142520 <CR>	<i>Wednesday, April First, 8:30:25 AM, 1998</i>

6.25 Advanced Feature Menu Request

Function : Returns the current setting of Industrial Player Menu.

Format : ?S

Explanation : The player returns the current setting of Industrial Player Menu. Basically, the return is expressed as some integer value. The value is made up with the sum of each argument you want. The default is 0 when the player was shipped. The player returns an error code if the command is issued when the player is showing Industrial Player Menu on the screen. See the description of Advanced Feature Menu Set (MS).

Execution :

Command String	Status Return	DVD-V7200
?S<CR>	112<CR>	<i>Title repeat mode (16) Baud rate is 9600bps (32) Tray lock on (64)</i>

6.26 Player Region Code Request

Function : Returns player region code

Format : ?H

Explanation : The command returns the player's region code(s).

Execution :

Command String	Status Return	DVD-V7200
?H<CR>	02<CR>	<i>Region Code 2</i>

6.27 CCR Mode Request

Function : Returns the current communication mode

Format : ?M

Explanation : The command returns the contents of the Communication Control Register (CCR).

The CCR default value is set to Mode 3 (ON).

CM2	Mode-2
CM3	Mode-3

Execution :

Command String	Status Return	DVD-V7200
?M<CR>	CM3<CR>	<i>CCR = 3 (Default Communication Mode)</i>

6.28 Input Number Request

Function : Returns input numbers

Format : ?N

Explanation : The player waits to send numbers through to any peripherals. If numbers are input, the player returns the input numbers.

Execution :

Command String	Status Return	DVD-V7200
?N<CR>		<i>Waits to input the numeric numbers</i>
7<CR>	7<CR>	<i>7 entered from keyboard</i>

6.29 Error Code Request

Function : Returns the latest error code

Format : ?E

Explanation : The player returns the most recent error codes. The report consists of Error Codes logged since the unit was turned on.

6.30 Input Unit Request

Function : Returns a code for data input through a Remote Control Unit

Format : #I

Explanation : The player returns a four-digit ASCII-Hex Code that represents input command data from a Remote Control Unit.

There are two type code, one is a four-digit code the other is a eight-digit code (extension code). When the input command data is two words (eight-digit) in length, the player truncates or shortens the information. A truncated code consists of an Upper Byte from the First Code and a Lower Byte from the Second Code. The player creates a Returning Code or Double Code from these two Bytes.

Once the player returns an Input Code, a FFFFh Code (no reactions from the Remote Control) repeats until a new code is sent from the Remote Control Unit.

Execution :

Command String	Status Return	DVD-V7200
#I<CR>	A39F<CR>	<i>Receives the Pause Key command - (A39F)</i>
#I<CR>	FFFFh<CR>	
#I<CR>	A3BE<CR>	<i>Receives the Audio Key command - (A399_AFBE)</i>
#I<CR>	FFFFh<CR>	

6.31 Input Barcode Data Request

Function : Returns input data through a Barcode Reader

Format : #B

Explanation : The player returns an ASCII Code that represents input command data from a Barcode reader.

NOTE: When the input data is unacceptable for the current disc type, the player returns an incorrect code.

Execution :

Command String	Status Return	DVD-V7200
#B<CR>	4307<CR>	<i>Receives a Play code about DVD disc</i>

6.32 Register A Request

Function : Returns the contents of Register A

Format : \$A

Explanation : The player returns a detailed list of the Register A attributes.

Status information is returned in the following format:

AC₈C₇C₆C₅C₄C₃C₂C₁<CR>

C ₈ , C ₇ , C ₆	(Fixed 0)		
C ₅		0 = Off	1 = On
C ₄	(Fixed 0)		
C ₃	Displays User's Area	0 = Off	1 = On
C ₂	Displays Title & Chapter Numbers	0 = Off	1 = On
C ₁	Displays Frame Number (DVD) or Time Code (CD, VCD)	0 = Off	1 = On

Execution :

Command String	Status Return	DVD-V7200
3RA<CR>	R<CR>	<i>Sets to Register A</i>
\$A<CR>	A0000011<CR>	<i>Requests information from Register A</i>

6.33 Register B Request

Function : Returns the contents of Register B

Format : \$B

Explanation : The player returns the Audio and Video squelch attributes from Register B.

Status information is returned in the following format:

BC₈C₇C₆C₅C₄C₃C₂C₁<CR>

C ₈	Video Squelch	0 = Permission Granted	1 = Forbidden
C ₇	Audio Squelch	0 = Permission Granted	1 = Forbidden
C ₆ to C ₁	(Fixed 0)		

Execution :

Command String	Status Return	DVD-V7200
128RB<CR>	R<CR>	<i>Sets the Register B</i>
\$B<CR>	B1000000<CR>	<i>Requests information from Register B</i>

6.34 Register D Request

Function : Returns the contents of Register D

Format : \$D

Explanation : The player returns the termination setting of TxD from Register D.

Status information is returned in the following format:

DC₈C₇C₆C₅C₄C₃C₂C₁<CR>

C ₈	Fixed 0		
C ₇	TxD termination	0 = CR	1 = CR + LF
C ₆	Fixed 0		
C ₅	Fixed 0		
C ₄	Fixed 0		
C ₃	Fixed 0		
C ₂	Fixed 0		
C ₁	Fixed 0		

Execution :

Command String	Status Return	DVD-V7200
64RB<CR>	R<CR>	<i>Sets the Register D</i>
\$D<CR>	D01000000<CR>	<i>Requests information from Register B</i>

6.35 Menu Call (DVD)

Function : Calls disc menu or goes back to the former address

Format : Integer MC

Explanation : If the disc has the disc menu in its contents, the root menu or the title menu comes up on the screen. Or while these menu have come up on the screen, the screen is returned to the address (that the player played or stilled before). The command specifies the menu type with two integer numbers.

Integer	Menu type
1	Title
2	Root

MC<CR>

If the player receives the command without any integer while playing a menu, the player go back to the address that it played or stilled before.

If the command is available in that player situation, the player returns immediately "R<CR>".
 In case the disc does not have the disc menu though the command [1 or 2 MC<CR>] is issued, an error message (E04) is returned.

*: If the command is available, the return "R<CR>" will be back on the screen right away after it's issued. But this does not show that the command is executed completely.

Execution :

Command String	Status Return	DVD-V7200
		Plays some video title
2MC<CR>	R<CR>	Shows the root menu
MC<CR>	E11<CR>	Goes back to the title before

6.36 Numeric Button (DVD)

Function : Selects the button and executes by number

Format : Integer NB

Explanation : The command selects the button in the menu that is played on the screen and executes the program that is assigned on it. The command emulates the "digit" key on the remote control unit while the button exists on the screen.

If the command is available in that player situation, the player returns immediately "R<CR>".
 If the disc that is being played does not have the button in that screen when the command is issued, an error message (E06) is returned.

*: If the command is available, the return "R<CR>" will be back on the screen right away after it's issued. But this does not show that the command is executed completely.

Execution :

Command String	Status Return	DVD-V7200
		Shows the disc menu
3BT<CR>	R<CR>	Selects and executes the button #3

6.37 Button Select (DVD)

Function : Selects the button (arrow key emulation)

Format : Integer CU

Explanation : The command selects the button in the menu that is played on the screen. The command emulates the "arrow" key on the remote control unit while the button exists on the screen. The command is specified the direction with four integer numbers.

Integer	directions
1	Up
2	Down
3	Left
4	Right

If the command is able to use in that player situation, the player returns immediately "R<CR>".

If the disc has not any button on the screen when the command is issued, an error message (E04) is returned.

*: If the command is available, the return "R<CR>" will be back on the screen right away after it's issued. But this does not show that the command is executed completely.

Execution :

Command String	Status Return	DVD-V7200
		Shows the disc menu
2CU<CR>	R<CR>	Moves to the below button from the prior one

6.38 Enter Button (DVD)

Function : Fixes the button and executes

Format : Integer ET

Explanation : The command fixes the button on the screen that is played after the execution of the command "CU" with any integer. Then a player executes the program that is assigned on the button. The command emulates the "enter" key on the remote control unit while the button exists on the screen.

If the command is able to use in that player situation, the player returns immediately "R<CR>".

If the disc that is being played has not the button in that screen when the command is issued, an error message (E04) is returned.

*: If the command is available, the return "R<CR>" will be back on the screen right away after it's issued. But this does not show that the command is executed completely.

Execution :

Command String	Status Return	DVD-V7200
		Shows the disc menu
2CU<CR>	R<CR>	Moves to the below button from the prior one

ET<CR>	R<CR>	Fixes the selection and executes the program that is assigned on it
--------	-------	---

Function : Emulates the "right" click of the mouse
 Format : argument1, argument2 ET
 Explanation : The command emulates the "right" click of the mouse while the arrow of the mouse is at the anywhere in the screen. The command specifies the position of the arrow of the mouse with two arguments. The format is below.

<u>argument 1,argument 2</u>	<u>position</u>
000000	Upper left limitation on the screen
719479	Lower right limitation on the screen
X ₁ X ₂ X ₃ Y ₁ Y ₂ Y ₃	anywhere in the screen

If the arguments are available, the player returns immediately "R<CR>".

If the arguments are not available number, an error message (E06) is returned.

*: The return "R<CR>" does not mean whether the button exists or not at the point and the button is available or not, the player check only argument number.

Execution :

Command String	Status Return	DVD-V7200
256384ET<CR>	R<CR>	Emulates the "right" click at the point (256,384) on the screen

6.39 Get Information (DVD)

Function : Gets the disc information
 Format : Integer GI
 Explanation : A player returns the information that is specified by 4 digits ID and 4 digits Sub-ID with the command.

<u>ID (000 X₁)</u>	<u>Sub-ID (00 Y₁ Y₂)</u>	<u>Return from the player</u>
0000	any number	E06 (argument error)
0001	0000 to 0023	System parameter information (4 digits data)
0001	more than 0023	E06 (argument error)
0002 or more	any number	E06 (argument error)

The player only returns system parameter information in case ID = 0001. The player returns E06 except available parameter.

The below is the simple list of the (SPRM) System Parameter. If you want more detailed information. (refer to "Table 4.6.1.2-1: System Parameters (SPRMs)" in "DVD Specifications for Read-Only Disc, Part 3 VIDEO SPECIFICATIONS")

SPRM	Explanation
0	Menu Description Language Code (M_LCD)
1	Audio stream number (ASTN) for TT_DOM
2	Sub-picture stream number (SPSTN) and On/Off flag for TT_DOM
3	Angle number (AGLN) for TT_DOM
4	Title number (TTN) for TT_DOM
5	VTS Title number (VTS_TTN) for TT_DOM
6	Title PGC number (TT_PGCN) for TT_DOM
7	Part_of_Title number (PTTN) for One_Sequential_PGC_Title
8	Highlighted Button number (HL_BTNN) for Selection state
9	Navigation Timer (NV_TMR)
10	TT_PGCN for NV_TMR
11	Player Audio Mixing Mode (P_AMXMD) for Karaoke
12	Country Code (CTY_LVL) for Parental Management
13	Parental Level (PTL_LVL)
14	Player Configuration (P_CFG) for Video
15	P_CFG for Audio
16	Initial Language Code (INI_LCD) for AST
17	INI_LCD_EXT for AST
18	INI_LCD for SPST
19	(INI_LCD_EXT) Initial Language Code extension for SPST
20	Player Region Code
21	reserved
22	reserved
23	reserved for extended playback mode

For example

SPRM(8): Highlighted Button number (HL_BTNN) for Selection state

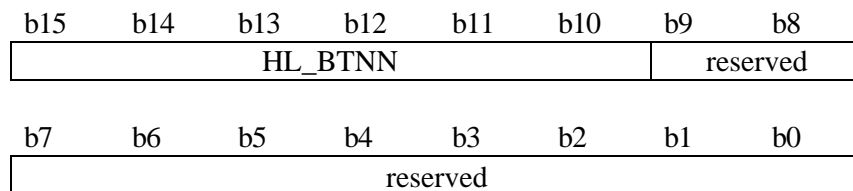

HL_BTNN..... 1 to 36: HL_BTNN value
 Others: reserved

Execution :

Command String	Status Return	DVD-V7200
00010008GI<CR>	1400<CR>	Selecting button #5 now

7. OPERATING MODES

The Operating or Active mode consists of five sub-modes; Open, Park, Setup, Random Access and Reject. A command causes the player to change from one sub-mode to another. The five sub-modes are described below.

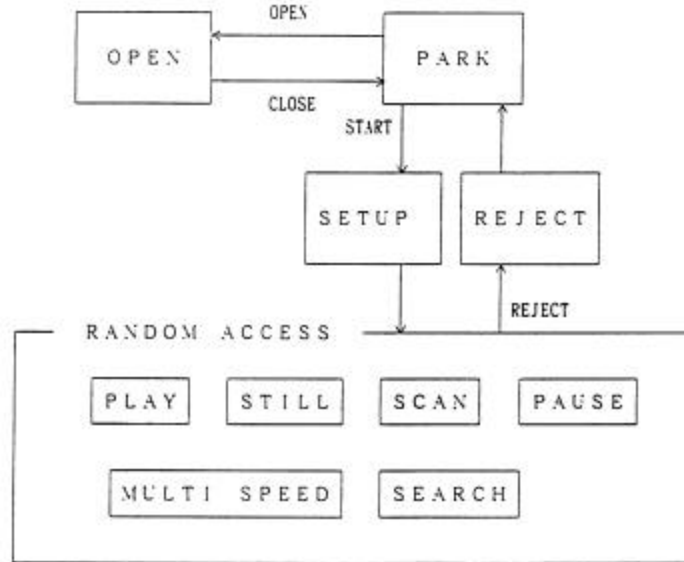

7.1 Open

The disc tray is open.

7.2 Park

The player enters the Park mode when the tray is closed.

7.3 Setup

If the Start command is sent while a disc is in the player, the disc spins up and the player proceeds with the Setup mode.

7.4 Random Access

The player enters the Random Access mode when the disc is ready for playback.

The Random Access mode is divided into six sub-modes; Play, Still, Scan, Pause, Multi Speed and Search. Various picture controls in the Random Access mode are available when playing back a DVD or VCD disc. The effects are achieved through highly, detailed mode transfers. Refer to the previous figure for mode relationship information.

7.5 Reject

When the Reject command is sent to the player, video playback stops. Once the disc rotation has stopped, the player enters the Park mode.

8. DVD-V7200 INTERNAL REGISTERS

When commands to the player are accompanied by arguments, (e.g., Title Number, Chapter Number, Time Code, etc.), argument values are set in the appropriate player registers. This chapter describes each internal register of the player.

8.1 Current Time/Frame

The register contains the current time while a DVD disc is playing; however, the register retains the frame number when a LB-compatible DVD disc (CAV) is running. A CD/VCD disc provides both a current time code and a block number within the register.

8.2 P-TIME

The P-TIME Register contains the elapsed time within a Track or a Chapter.

8.3 Current Title/Track (Current Chapter)

The register contains the current Title/Track Number (Chapter Number).

8.4 Current Index

The register contains the current Index number.

8.5 Serial Digit Buffer

The register contains the command argument values. The commands are placed in a separate, exclusive register.

When the player evaluates a command, the contents of the buffer are transferred to a specified register.

8.6 Remote Control Use Address Flag

When the Remote Control Unit sends a Search request to the player, a flag specifies if the address assigned is a title/track, chapter, time or frame.

8.7 Remote Control Digit Buffer

The register contains the numbers input by the Remote Control Unit.

8.8 Remote Control Data Register

The register contains the temporary data input by the Remote Control Unit.

8.9 Laser Barcode Buffer

The register contains the compatible Laser Barcode data transmitted via the Remote Control Unit.

8.10 Serial Use Address Flag

When the Serial Interface controls the player, a flag specifies if the address assigned is a title/track, chapter, time, frame, index, block or ID.

8.11 Search Time/Frame

The register contains a goal Title/track number (chapter number) which displays as a frame number, time code or block number.

8.12 Search Title/Track (Search Chapter)

The register contains a goal Title/track number (chapter number) during a search.

The function is identical to the Search Time/Frame command (reference 8.11 above).

8.13 Search Index

The register contains a goal index number during a search.

The function is identical to the Search Time/Frame command (reference 8.11 above).

8.14 Mark Time/Frame

The register contains a marker (representing the frame number, time code or block number) which indicates the end point of an Auto Play.

When the player performs an Auto Play, the contents of the Mark Time/Frame and the Current Time/Frame are compared.

8.15 Mark Title/Track (Mark Chapter)

The register contains the title/track (mark chapter) as a marker.

The function is identical to the Mark Time/Frame command (reference 8.14 above).

8.16 Mark Index

The register contains the index number as a marker.

The function is identical to the Mark Time/Frame command (reference 8.14 above).

8.17 Video Control

The player uses the register to control the Video ON/OFF switch.

8.18 Audio Control

The player uses the register to select the audio output.

8.19 Display Control

The player uses the register to control the Character Display ON/OFF switch.

The Character Display tracks on-screen information such as time/frame number, title/track number, etc.

8.20 Registers

There are three (3) registers, A, B and C. The registers are reserved exclusively for CPU internal operations.

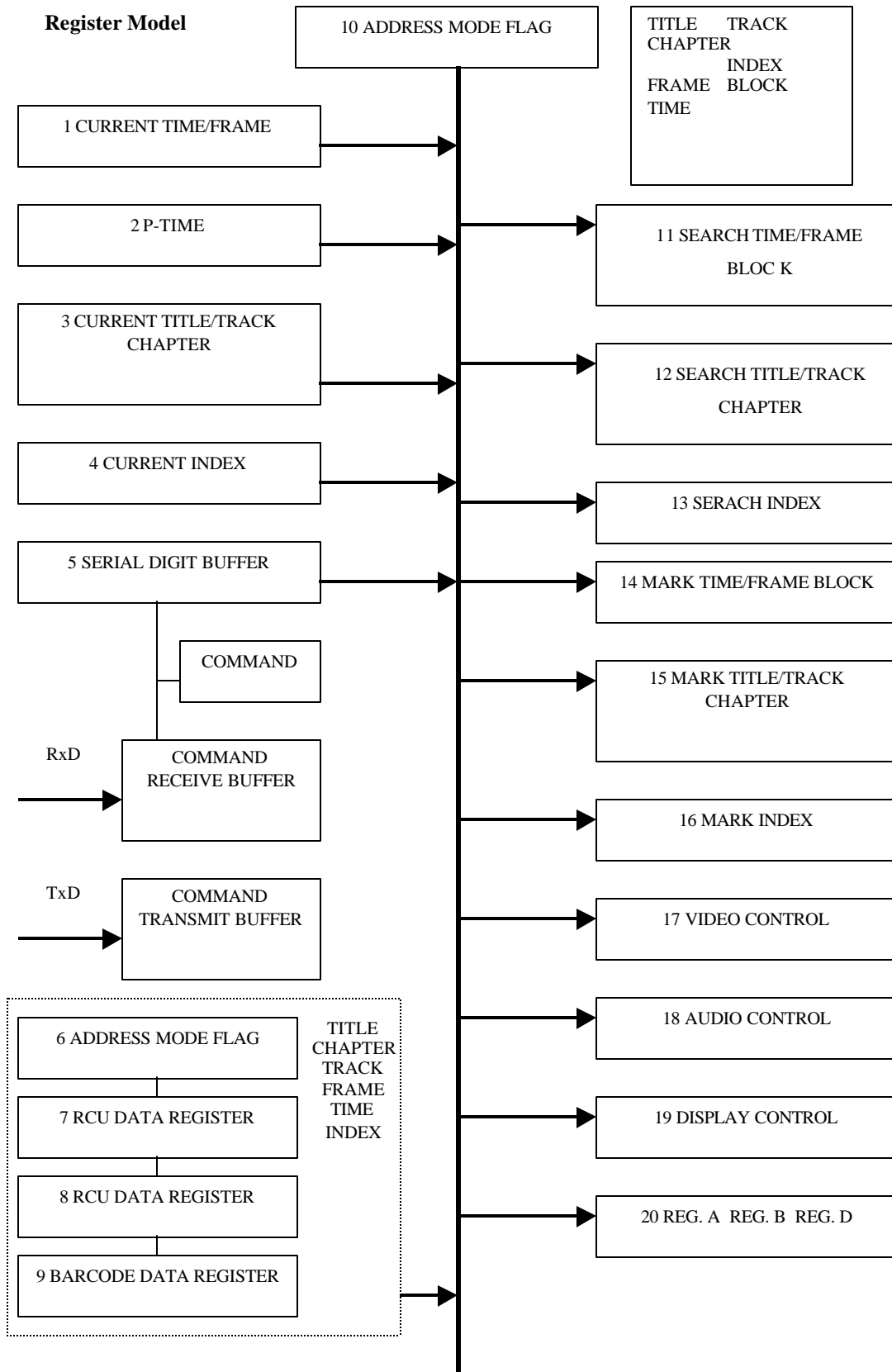

9. EXTERNAL SWITCH CONTROL

To control the player through the Serial Interface Connector, use a special switching circuit. The circuit pins must terminate to a +5 volts DC with an internal 20,000 ohms resistor.

To activate a function, create a switch contact with an electrical ground (Pin 1). Check Chapter 2 to verify pin (Pin 6 through Pin 13) and terminal (SW1 ~ SW8) assignments.

9.1 Function Assignment

Create a Circuit Controller or a Diode Matrix Circuit. Refer to the table below for assistance.

Diode Assignment List

SW1	SW2	SW3	SW4	SW5	SW6	SW7	SW8	Function
				ENTER	X	Y	Z	
X								
	X							
		X						
			X					
				X				ENTER
					X			STACK GROUP1
						X		STACK GROUP2
							X	STACK GROUP3
X			X					™
	X		X					(
	X	X						Σ
X		X						©
				X	X			PLAY
				X		X		STOP
				X			X	PAUSE
				X	X	X		STEP FORWARD
				X	X		X	STEP REVERSE
				X		X	X	RETURN
X	X							OPEN/CLOSE
		X	X					DISPLAY
X	X	X						SCAN FORWARD
X	X		X					SCAN REVERSE
X		X	X					SKIP FORWARD
	X	X	X					SKIP REVERSE
X					X			1
	X				X			2
		X			X			3
			X		X			4
X						X		5
	X					X		6
		X				X		7
			X			X		8
X							X	9
	X						X	10
		X					X	11
			X				X	12
X	X				X			13
X		X			X			14

X			X		X			15
	X	X			X			16
	X		X		X			17
		X	X		X			18
X					X	X		19
	X				X	X		20

Diode Assignment List (cont.)

SW1	SW2	SW3	SW4	SW5	SW6	SW7	SW8	Function
				ENTER	X	Y	Z	
		X			X	X		STACK GROUP4
			X		X	X		STACK GROUP5
X	X					X		STACK GROUP6
X		X				X		STACK GROUP7
X			X			X		STACK GROUP8
	X	X				X		STACK GROUP9
	X		X			X		STACK GROUP10
		X	X			X		STACK GROUP11
X						X	X	STACK GROUP12
	X					X	X	STACK GROUP13
		X				X	X	STACK GROUP14
			X			X	X	STACK GROUP15
X	X						X	STACK GROUP16
X		X					X	STACK GROUP17
X			X				X	STACK GROUP18
	X	X					X	STACK GROUP19
	X		X				X	STACK GROUP20
		X	X				X	STACK GROUP21
X					X		X	STACK GROUP22
	X				X		X	STACK GROUP23
		X			X		X	STACK GROUP24
			X		X		X	STACK GROUP25
					X	X		STACK GROUP26
					X		X	STACK GROUP27
						X	X	TITLE MENU
					X	X	X	MENU

9.2 Controller

Examples of Switch and Diode specifications are charted below.

Switch Specifications

On Resistance	Less than 1 ohm
Off Resistance	More than 1 M ohm
Type	Non-Locking

Diode Specifications

Forward Voltage Drop (VF)	Less than 0.7 (IF 1ma)
Surge Forward Current (IFSM)	Less than 100ma
Forward Current	Less than 10ma

9.2.1 Simple Circuit

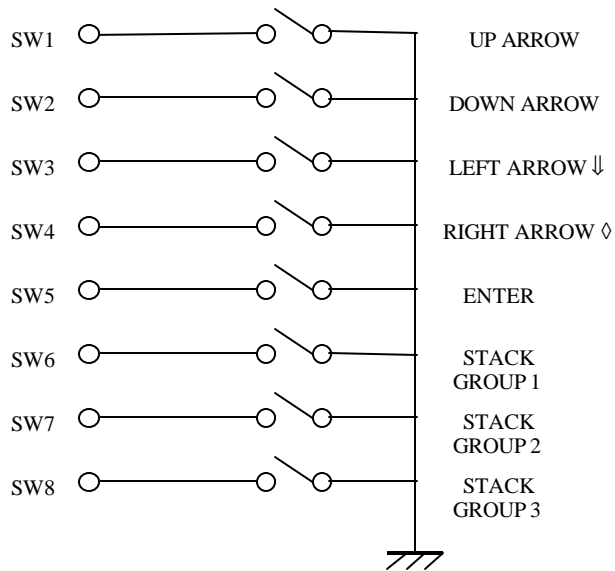

9.2.2 Diode Matrix Circuit

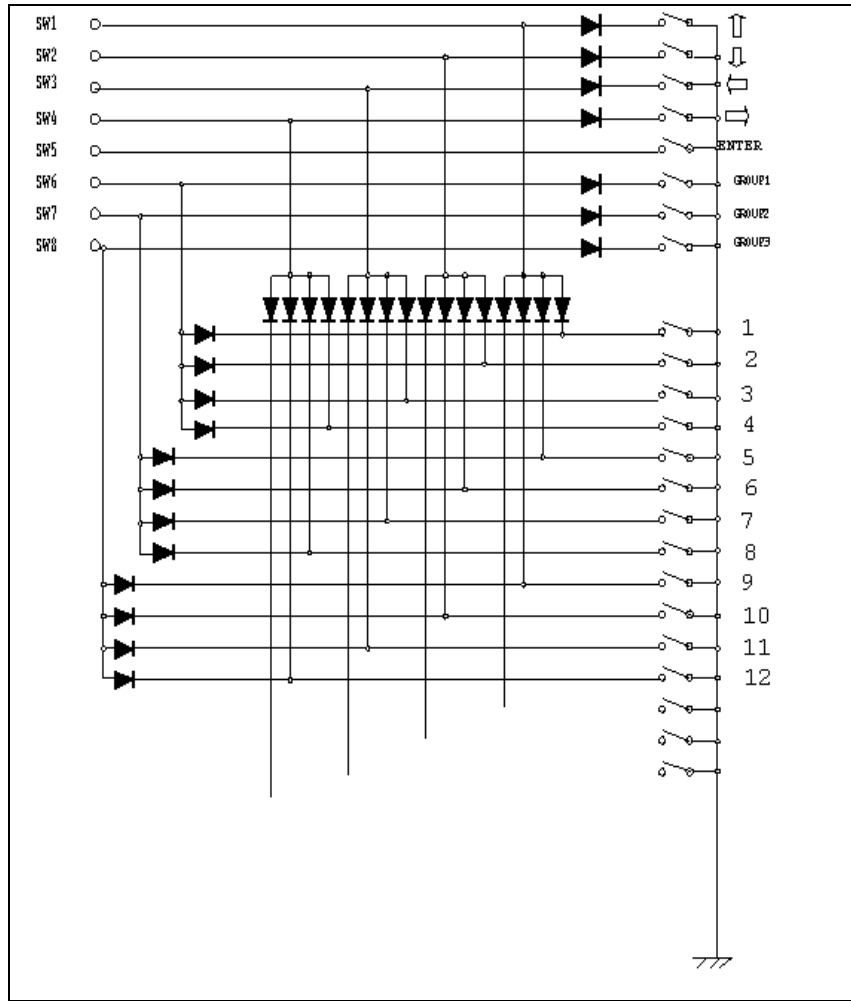

10. ADDITIONAL NOTES

1. If the disc that is currently playing has a picture stop code recorded, when the player reaches the stop code point, it enters Still Mode.
2. If Prohibit Pause is set for Stop Marker playback, an error is issued at any Stop Marker Point.
3. Whenever a computer controls the player, send the KEY LOCK command to eliminate possible interference from the front panel buttons and/or the remote control unit.
4. If an address that does not exist is set in a command for a CD or VCD disc, error E04 is returned.

APPENDIX A - COMPLETE COMMAND LIST BY NAME

NOTE: Any command prefaced with an * will be supported by firmware upgrade.

NOTE: Any command with an argument or address parameter will be prefaced by arg and ards, argument and address, respectively. If arg or ards are in (), then the parameter is optional.

COMMAND		SUPPORTING FORMATS			
Name	Mnemonic	DVD	LB comp. DVD	CD	VCD
Audio Control	arg AD	x	x	x	x
*BANK Data Download Execute	BD	x	x	x	x
*BANK Data Upload Execute	BU	x	x	x	x
*Block Text Input	arg BI	x	x	x	x
Barcode Stack Play	arg BS	x	x	x	N/A
Block Number	BK			x	x
Block Number Request	?B			x	x
CCR Mode Request	?M	x	x	x	x
CD Disc Status Request	?K			x	x
Chapter	CH	x	x		
Chapter Number Request	?C	x	x		
Clear	CL	x	x	x	x
Clear Screen	CS	x	x	x	x
Close	CO	x	x	x	x
Communication Control Set	arg CM	x	x	x	x
Current Address Request	?A	x	x	x	x
Disc Region code Request	?G	x	x		
Display Control	arg DS	x	x	x	x
DVD Disc Status Request	?V	x	x		
Error Code Request	?E	x	x	x	x
Frame	FR	x	x		
Frame Number Request	?F	x	x		
Index	IX			x	x
Index Number Request	?I			x	x
Input Barcode Data Request	#B	x	x	x	x
Input Number Request	?N	x	x	x	x
Input Unit Request	#I	x	x	x	x
Key Lock	arg KL	x	x	x	x
LD Disc Status Request	?D		x		
Lead Out Symbol	LO	x	x	x	x
LVP Model Name Request	?X	x	x	x	x
Multi-Speed Forward	(adrs) MF	x	x		x
Multi-Speed Reverse	(adrs) MR	x	x		
Open	(arg) OP	x	x	x	x
Pause	PA	x	x	x	x
Play	(adrs) PL	x	x	x	x

COMMAND		SUPPORTING FORMATS			
Name	Mnemonic	DVD	LB comp. DVD	CD	VCD
Print Character	arg PR	x	x	x	x
Real Time Clock Request	?W	x	x	x	x
Real Time Clock Set	WW	x	x	x	x
Register A Request	\$A	x	x	x	x
Register A Set (Display)	arg RA	x	x	x	x
Register B Request	\$B	x	x	x	x
Register B Set (Squelch)	arg RB	x	x	x	x
Reject	RJ	x	x	x	x
Scan Forward	NF	x	x	x	x
Scan Reverse	NR	x	x	x	x
Scan Stop	NS	x	x	x	x
Search	adrs SE	x	x	x	x
Select Angle	arg AG	x	x		
Select Aspect	arg AP	x	x		
Select Audio	arg AU	x	x	x	x
Select Subtitle	arg SU	x	x		
Speed	arg SP	x	x		x
Stack Group Set	arg GP	x	x	x	x
Start	SA	x	x	x	x
Step Forward	SF	x	x		x
Step Reverse	SR	x	x		
Still	ST	x	x		x
Stop Marker	adrs SM	x	x	x	x
Time	TM	x	x	x	x
Time Code Request	?T	x	x	x	x
Title	TI	x	x		
Title/Track Number Request	?R	x	x	x	x
TOC Information Request	(arg) ?Q	N/A	N/A	x	x
Track	TR			x	x
*UDF Data Upload Execute	UU	x	x		
Video Blackboard Display	arg VS	x	x		
Video Control	arg VD	x	x	x	x

APPENDIX B - COMPLETE COMMAND LIST BY MNEMONIC

NOTE: Any command prefaced with an * will be supported by firmware upgrade.

NOTE: Any command with an argument or address parameter will be prefaced by arg and ards, argument and address, respectively. If arg or ards are in (), then the parameter is optional.

COMMAND		SUPPORTING FORMATS			
Mnemonic	Name	DVD	LB comp. DVD	CD	VCD
#B	Input Barcode Data Request	x	x	x	x
#I	Input Unit Request	x	x	x	x
\$A	Register A Request	x	x	x	x
\$B	Register B Request	x	x	x	x
?A	Current Address Request	x	x	x	x
?B	Block Number Request			x	x
?C	Chapter Number Request	x	x		
?D	LD Disc Status Request		x		
?E	Error Code Request	x	x	x	x
?F	Frame Number Request	x	x		
?G	Disc Region code Request	x	x		
?H	Player Region Code Request	x	x	x	x
?I	Index Number Request			x	x
?K	CD Disc Status Request			x	x
?M	CCR Mode Request	x	x	x	x
?N	Input Number Request	x	x	x	x
?P	Player Active Mode Request	x	x	x	x
(arg) ?Q	TOC Information Request	N/A	N/A	x	x
?R	Title/Track Number Request	x	x	x	x
?T	Time Code Request	x	x	x	x
?V	DVD Disc Status Request	x	x		
?W	Real Time Clock Request	x	x	x	x
?X	LVP Model Name Request	x	x	x	x
arg AD	Audio Control	x	x	x	x
arg AG	Select Angle	x	x		
arg AP	Select Aspect	x	x		
arg AU	Select Audio	x	x	x	x
BD	*BANK Data Download Execute	x	x	x	x
arg BI	*Block Text Input	x	x	x	x
BK	Block Number			x	x
arg BS	Barcode Stack Play	x	x	x	N/A
BU	*BANK Data Upload Execute	x	x	x	x
CH	Chapter	x	x		

COMMAND		SUPPORTING FORMATS				
Mnemonic	Name	DVD	LB comp. DVD	CD	VCD	
	CL	Clear	x	x	x	x
arg	CM	Communication Control Set	x	x	x	x
	CO	Close	x	x	x	x
	CS	Clear Screen	x	x	x	x
arg	DS	Display Control	x	x	x	x
	FR	Frame	x	x		
arg	GP	Stack Group Set	x	x	x	x
	IX	Index			x	x
arg	KL	Key Lock	x	x	x	x
	LO	Lead Out Symbol	x	x	x	x
(adrs)	MF	Multi-Speed Forward	x	x		x
(adrs)	MR	Multi-Speed Reverse	x	x		
	NF	Scan Forward	x	x	x	x
	NR	Scan Reverse	x	x	x	x
	NS	Scan Stop	x	x	x	x
(arg)	OP	Open	x	x	x	x
	PA	Pause	x	x	x	x
(adrs)	PL	Play	x	x	x	x
arg	PR	Print Character	x	x	x	x
arg	RA	Register A Set (Display)	x	x	x	x
arg	RB	Register B Set (Squelch)	x	x	x	x
	RJ	Reject	x	x	x	x
	SA	Start	x	x	x	x
Adrs	SE	Search	x	x	x	x
	SF	Step Forward	x	x		x
Adrs	SM	Stop Marker	x	x	x	x
arg	SP	Speed	x	x		x
	SR	Step Reverse	x	x		
	ST	Still	x	x		x
arg	SU	Select Subtitle	x	x		
	TI	Title	x	x		
	TM	Time	x	x	x	x
	TR	Track			x	x
	UU	*UDF Data Upload Execute	x	x		
arg	VD	Video Control	x	x	x	x
arg	VS	Video Blackboard Display	x	x		
	WW	Real Time Clock Set	x	x	x	x

APPENDIX C - DVD COMMAND LIST

NOTE: Any command prefaced with an * will be supported by firmware upgrade.

NOTE: Any command with an argument or address parameter will be prefaced by arg and ards, argument and address, respectively. If arg or ards are in (), then the parameter is optional.

COMMAND	
Name	Mnemonic
Audio Control	arg AD
*BANK Data Download Execute	BD
*BANK Data Upload Execute	BU
Barcode Stack Play	arg BS
*Block Text Input	arg BI
CCR Mode Request	?M
Chapter	CH
Chapter Number Request	?C
Clear	CL
Clear Screen	CS
Close	CO
Communication Control Set	arg CM
Current Address Request	?A
Disc Region code Request	?G
Display Control	arg DS
DVD Disc Status Request	?V
Error Code Request	?E
Frame	FR
Frame Number Request	?F
Input Barcode Data Request	#B
Input Number Request	?N
Input Unit Request	#I
Key Lock	arg KL
Lead Out Symbol	LO
LVP Model Name Request	?X
Multi-Speed Forward	(adrs) MF
Multi-Speed Reverse	(adrs) MR
Open	(arg) OP
Pause	PA
Play	(adrs) PL
Player Active Mode Request	?P
Player Region Code Request	?H
Print Character	arg PR
Real Time Clock Request	?W
Real Time Clock Set	WW
Register A Request	\$A
Register A Set (Display)	arg RA
Register B Request	\$B

COMMAND		
Mnemonic	Name	
Register B Set (Squelch)	arg	RB
Reject		RJ
Scan Forward		NF
Scan Reverse		NR
Scan Stop		NS
Search	adrs	SE
Select Angle	arg	AG
Select Aspect	arg	AP
Select Audio	arg	AU
Select Subtitle	arg	SU
Speed	arg	SP
Stack Group Set	arg	GP
Start		SA
Step Forward		SF
Step Reverse		SR
Still		ST
Stop Marker	adrs	SM
Time		TM
Time Code Request		?T
Title		TI
Title/Track Number Request		?R
*UDF Data Upload Execute		UU
Video Blackboard Display	arg	VS
Video Control	arg	VD

APPENDIX D - LB COMPATIBLE DVD COMMAND LIST

NOTE: Any command prefaced with an * will be supported by firmware upgrade.

NOTE: Any command with an argument or address parameter will be prefaced by arg and ards, argument and address, respectively. If arg or ards are in (), then the parameter is optional.

COMMAND	
Name	Mnemonic
Audio Control	arg AD
*BANK Data Download Execute	BD
*BANK Data Upload Execute	BU
Barcode Stack Play	arg BS
*Block Text Input	arg BI
CCR Mode Request	?M
Chapter	CH
Chapter Number Request	?C
Clear	CL
Clear Screen	CS
Close	CO
Communication Control Set	arg CM
Current Address Request	?A
Disc Region code Request	?G
Display Control	arg DS
DVD Disc Status Request	?V
Error Code Request	?E
Frame	FR
Frame Number Request	?F
Input Barcode Data Request	#B
Input Number Request	?N
Input Unit Request	#I
Key Lock	arg KL
LD Disc Status Request	?D
Lead Out Symbol	LO
LVP Model Name Request	?X
Multi-Speed Forward	(adrs) MF
Multi-Speed Reverse	(adrs) MR
Open	(arg) OP
Pause	PA
Play	(adrs) PL
Player Active Mode Request	?P
Player Region Code Request	?H
Print Character	arg PR
Real Time Clock Request	?W
Real Time Clock Set	WW
Register A Request	\$A
Register A Set (Display)	arg RA

COMMAND		
Mnemonic	Name	
Register B Request		\$B
Register B Set (Squelch)	arg	RB
Reject		RJ
Scan Forward		NF
Scan Reverse		NR
Scan Stop		NS
Search	adrs	SE
Select Angle	arg	AG
Select Aspect	arg	AP
Select Audio	arg	AU
Select Subtitle	arg	SU
Speed	arg	SP
Stack Group Set	arg	GP
Start		SA
Step Forward		SF
Step Reverse		SR
Still		ST
Stop Marker	adrs	SM
Time		TM
Time Code Request		?T
Title		TI
Title/Track Number Request		?R
*UDF Data Upload Execute		UU
Video Blackboard Display	arg	VS
Video Control	arg	VD

APPENDIX E - CD COMMAND LIST

The DVD-V7200 supports the following commands.

NOTE: Any command prefaced with an * will be supported by firmware upgrade.

NOTE: Any command with an argument or address parameter will be prefaced by arg and ards, argument and address, respectively. If arg or ards are in (), then the parameter is optional.

COMMAND	
Name	Mnemonic
Audio Control	arg AD
*BANK Data Download Execute	BD
*BANK Data Upload Execute	BU
Barcode Stack Play	arg BS
Block Number	BK
Block Number Request	?B
*Block Text Input	arg BI
CCR Mode Request	?M
CD Disc Status Request	?K
Clear	CL
Clear Screen	CS
Close	CO
Communication Control Set	arg CM
Current Address Request	?A
Display Control	arg DS
Error Code Request	?E
Index	IX
Index Number Request	?I
Input Barcode Data Request	#B
Input Number Request	?N
Input Unit Request	#I
Key Lock	arg KL
Lead Out Symbol	LO
LVP Model Name Request	?X
Open	(arg) OP
Pause	PA
Play	(adrs) PL
Player Active Mode Request	?P
Player Region Code Request	?H
Print Character	arg PR
Real Time Clock Request	?W
Real Time Clock Set	WW
Register A Request	\$A
Register A Set (Display)	arg RA
Register B Request	\$B
Register B Set (Squelch)	arg RB

COMMAND	
Mnemonic	Name
Reject	RJ
Scan Forward	NF
Scan Reverse	NR
Scan Stop	NS
Search	adrs SE
Select Audio	arg AU
Stack Group Set	arg GP
Start	SA
Stop Marker	adrs SM
Time	TM
Time Code Request	?T
Title/Track Number Request	?R
TOC Information Request	(arg) ?Q
Track	TR
Video Control	arg VD

APPENDIX F - VCD COMMAND LIST

The DVD-V7200 supports the following commands.

NOTE: Any command prefaced with an * will be supported by firmware upgrade.

NOTE: Any command with an argument or address parameter will be prefaced by arg and ards, argument and address, respectively. If arg or ards are in (), then the parameter is optional.

COMMAND	
Name	Mnemonic
Audio Control	arg AD
*BANK Data Download Execute	BD
*BANK Data Upload Execute	BU
Block Number	BK
Block Number Request	?B
*Block Text Input	arg BI
CCR Mode Request	?M
CD Disc Status Request	?K
Clear	CL
Clear Screen	CS
Close	CO
Communication Control Set	arg CM
Current Address Request	?A
Display Control	arg DS
Error Code Request	?E
Index	IX
Index Number Request	?I
Input Barcode Data Request	#B
Input Number Request	?N
Input Unit Request	#I
Key Lock	arg KL
Lead Out Symbol	LO
LVP Model Name Request	?X
Multi-Speed Forward	(adrs) MF
Open	(arg) OP
Pause	PA
Play	(adrs) PL
Player Active Mode Request	?P
Player Region Code Request	?H
Print Character	arg PR
Real Time Clock Request	?W
Real Time Clock Set	WW
Register A Request	\$A
Register A Set (Display)	arg RA
Register B Request	\$B
Register B Set (Squelch)	arg RB

COMMAND	
Mnemonic	Name
Reject	RJ
Scan Forward	NF
Scan Reverse	NR
Scan Stop	NS
Search	adrs SE
Select Audio	arg AU
Speed	arg SP
Stack Group Set	arg GP
Start	SA
Step Forward	SF
Still	ST
Stop Marker	adrs SM
Time	TM
Time Code Request	?T
Title/Track Number Request	?R
TOC Information Request	(arg) ?Q
Track	TR
Video Control	arg VD

Appendix G - Error Codes

Code	Message	Description
E00	communication error	Communication Line Error due to framing error or buffer overflow.
E04	feature not available	Non-Usable Function has been tried. Either the command mnemonic is wrong or the command can not be used in this mode.
E06	missing argument	Necessary parameter is not specified.
E11	disc does not exist	There is no disc in the tray.
E12	search error	Search address can not be found.
E13	defocusing error	Laser Error - unfocused laser.
E15	picture stop	Playback has been stopped by a picture stop code while in auto play mode.
E16	interrupt by other device	The command(s) sent via the serial line were not executed before commands were sent from the front panel buttons and/or remote control unit.
E99	panic	Unrecoverable Error occurred. Is possible a disc can not be loaded and/or playing can not continue.

DVD-V7200

Industrial DVD Player RS-232 Command Protocol

Pioneer Electronic Corporation

4-1, Meguro 1-chome
Meguro-ku, Tokyo 153
JAPAN

<http://www.pioneer.co.jp>

Pioneer New Media Technologies, Inc.

2265 East 220th Street
Long Beach, California 90810
United States of America
(310) 952-2111

<http://www.pioneerusa.com>