

Pioneer *sound.vision.soul*



Raising the standard...
Pioneer's ultimate mid-size plasma display with
True Progressive XGA resolution.

43-inch XGA Professional Plasma Display

PDP-433CMX

PURE
VISION

XGA 43 inch

Unparalleled image quality in a thin, energy efficient, industrial display panel.

Pioneer's plasma displays have become the preferred standard for applications like information visualization, large area viewing, command control centers, information kiosks and retail signage. Pioneer's extensive understanding of industrial displays, leading edge product design and manufacturing ability has all gone into producing this new PDP-433CMX plasma display. The PDP-433CMX takes PDP performance to an entirely new level. Pioneer has succeeded in increasing brightness and color reproduction quality, while also increasing reliability, operating ease and versatility. Its energy star certification has established a new level of energy-efficiency and environmental friendliness for PDPs. With its 43-inch True XGA 16:9 screen (diagonally measured), it's a bit wider and far superior to the usual 42-inch models. With all of these advantages, the PDP-433CMX weighs only 69 lbs. Choose the PDP-433CMX and discover why it's the best choice for professional display applications.

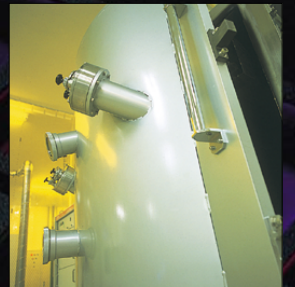
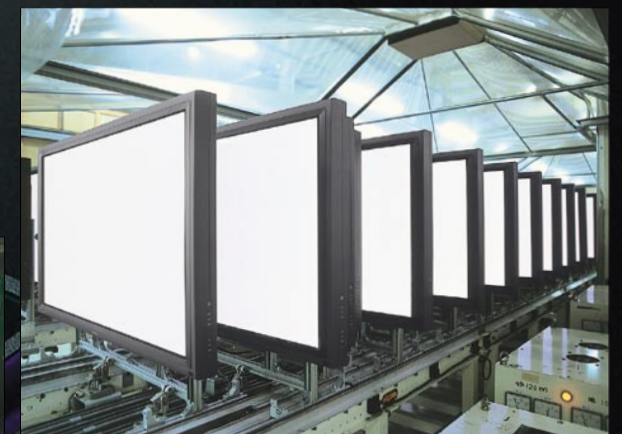

Pioneer is the world leader in PDP technology and products.

Pioneer continues to be the world leader in the introduction of improved PDP technology and products. The superior performance of the PDP-433CMX demonstrates why PDPs are truly the future of professional image displays. Unlike other PDP suppliers, Pioneer develops, designs and manufactures PDPs entirely in-house. You will see Pioneer PDPs at airports, shopping malls, showrooms, hospitals, company presentation rooms . . . in fact, anyplace where the goal is to inform or entertain with large, high quality images.

PDP Advantages



Wide, Flat and Thin

Compared to ordinary CRT monitors, the PDP screen is perfectly flat, yet elegantly slim — only 98mm (3-7/8") deep. There really is no comparison.



Lightweight for Easy Mounting

PDP units are much lighter than CRT monitors. They can be affixed to a mobile, floor or tabletop stand, or easily mounted on walls and ceilings horizontally, vertically or anything in between.



Wider Viewing Angle

PDPs provide a wider consistent viewing angle than conventional monitors — more than 160°, both horizontally and vertically. Spectators are ensured of a clear view from the sides or below the screen, which is ideal for public displays.



High Precision Imaging

PDPs deliver a high precision, distortion-free, evenly illuminated image out to the corners of the screen. Instant set-up and convergence-free operation ensures superb image quality.

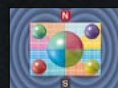

Free from Magnetic Interference

Unlike CRT devices, PDPs do not suffer from image distortion or color inaccuracy due to magnetic fields.



PURE
VISION

43-inch XGA Professional Plasma Display
PDP-433CMX

Pioneer PDP Technology Keeps Improving — And the Results Are Clearly Visible!

43-inch XGA Professional Plasma Display **PDP-433CMX**

Unparalleled Bright, High Contrast, Accurate Color Images Displayed with No Flicker.

The PDP-433CMX is currently the brightest plasma display and leads the industry with its superior contrast and color. Because PDP displays are often used in bright environments, the PDP-433CMX's high brightness and ambient light management prevents the loss of detail and the washed out appearance symptomatic of other PDPs. One of the main technologies behind this amazing performance is Pioneer's unique Deep Encased Cell Structure. Compared to the low rows of cells used in other PDPs, the Deep Encased Cells increase phosphor area by over 40%* and prevent light leakage from neighboring cells. Luminous efficiency is much higher, so the screen is much brighter and clearly visible under all conditions. * Compared to straight-type panels of the same size.

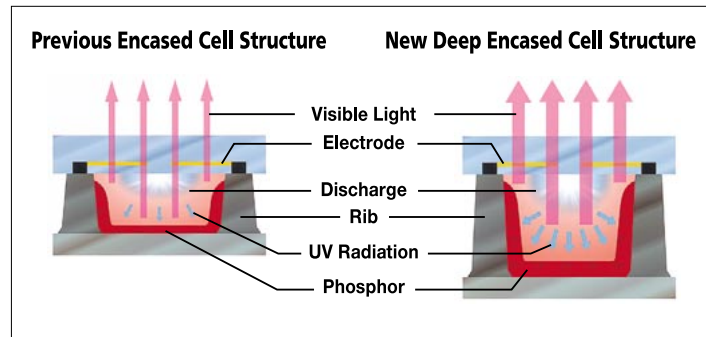

Conventional straight-type cell structure

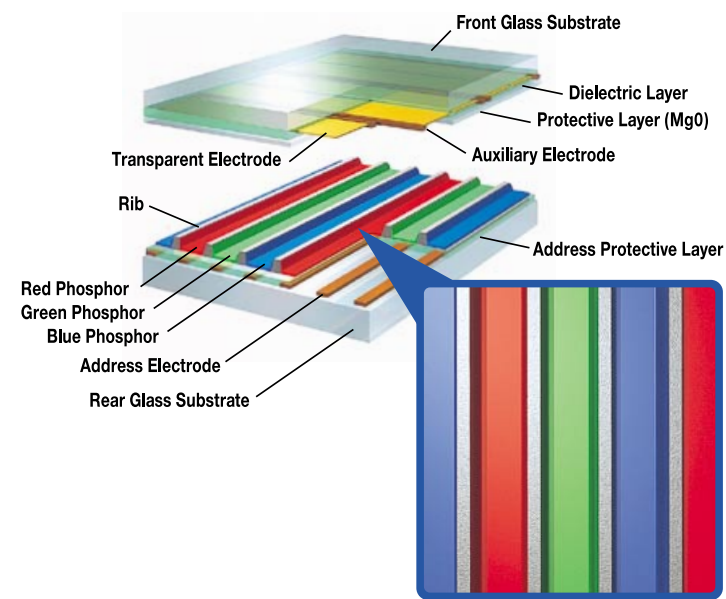

Pioneer's Deep Encased Cell Structure

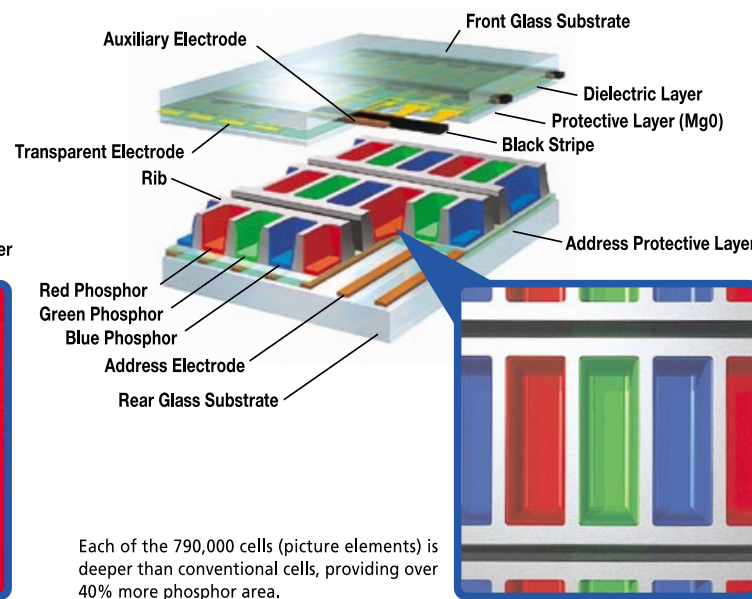

Each of the 790,000 cells (picture elements) is deeper than conventional cells, providing over 40% more phosphor area.

Pure Color Filter Improves Contrast, Color and Ambient Light Management

Pioneer's unique Pure Color Filter decreases light reflection for better contrast and filters out unnecessary elements in the red, green and blue light for purer color reproduction. You can be confident that your images will look impressive and accurate.

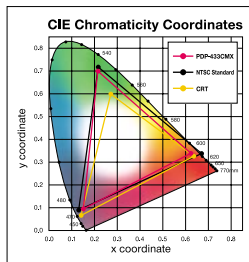

Brighter, More Accurate Colors

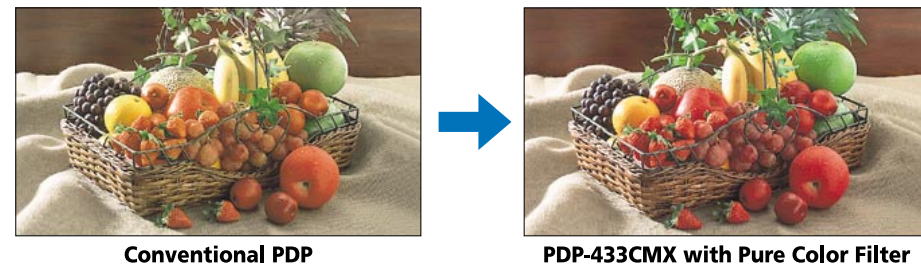

Excellent Contrast Under All Lighting Conditions

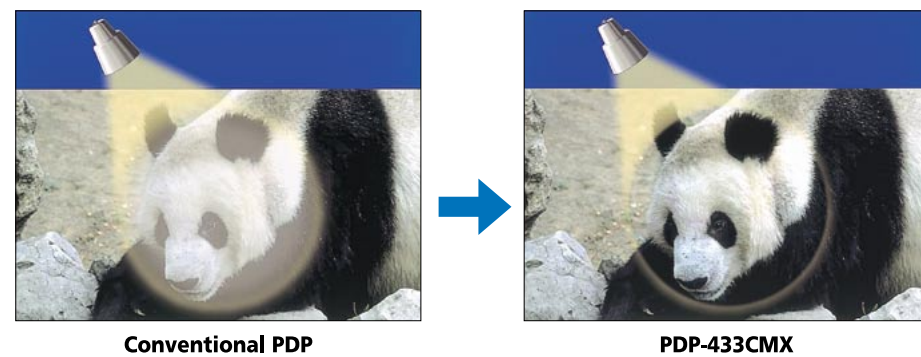

Greatly Improved Bright Contrast Means Clear Display Even in Bright Locations.

The exterior light reflectivity of the panel itself has been increased by black stripes and by improving the glass used to make the panel. The Pure Color Filter reduces the reflected external light component, resulting in bright contrast that is over two times higher than the previous level. You'll enjoy beautiful displays even in environments exposed to bright light.

Superior Grayscale Rendering

Pioneer utilizes a technology called Advanced Continuous Emission Display to achieve excellent grayscale rendering in dark areas, where conventional PDPs perform poorly. 10-bit sampling per color pixel, rather than the usual 8 bits, increases gray shades and produces smooth transitions from black to gray, with grayscale rendering about 16 times better than other PDPs. This technology eliminates the false contours (sharp edges where there should be smooth contours) and inaccurate quantization seen in other PDPs.

More Gray Shades in the Low Brightness Range

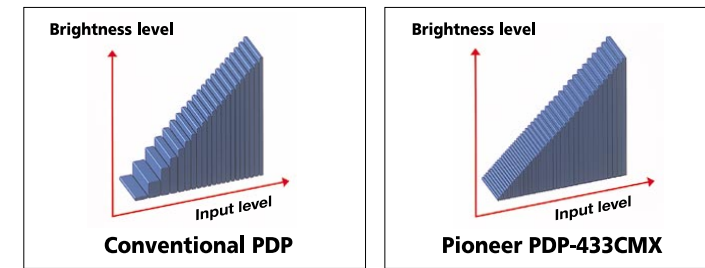

Better Rendering of Details in Dark Areas

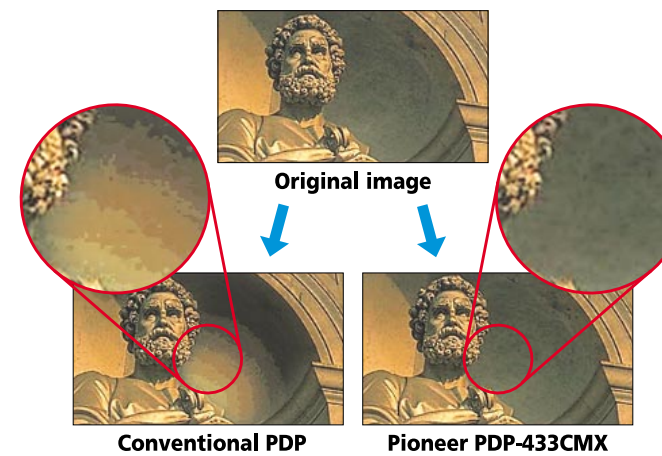

Compatibility with a Wide Range of PC Signals

With a native resolution of 1024 x 768, this high precision panel can accurately display personal computer signals ranging from 640 x 400 and 640 x 480 (VGA) to 1024 x 768 (XGA). It can also support compression display of 1280 x 768 (Wide XGA), 1280 x 1024 (SXGA) and 1600 x 1200 (UXGA) signals. In addition, Pioneer's proprietary scaling technology enables a circle to be displayed as a circle onto 1024 x 768 at 16:9 with 1280 x 768 signal input.

VGA	SVGA	XGA	WXGA	SXGA	UXGA
640 480 DOT BY DOT (640x480)	800 600 DOT BY DOT (800x600)	1024 768 DOT BY DOT (1024x768)			
4:3 (768x768)	4:3(TYPE) (768x768) *Compressed	4:3(TYPE) (768x768) *Compressed		4:3(TYPE) (720x768) *Compressed	4:3(TYPE) (768x768) *Compressed
FULL (1024x768)	FULL (1024x768)		FULL(TYPE) (1024x768) *Compressed	FULL(TYPE) (1024x768) *Compressed	FULL(TYPE) (1024x768) *Compressed

Achievement of the Industry's Lowest Power Consumption (298W)

The PDP-433CMX has achieved power consumption of 298W, astonishingly low for a 43-inch XGA-class plasma display. Standby power is only 0.9W. It also has a Power Save Mode that lowers the power consumption by as much as 20% below that of normal use. In addition, the PDP-433CMX satisfies the standards of the International Energy Star Program. * When optional card is not used.



Slim, Lightweight Design Means Greater Versatility

For a 43-inch large-screen display, the PDP-433CMX is amazingly thin and lightweight — only 3-7/8" deep and 69 lbs. 7 oz. Designed with industrial installations in mind, an efficient cooling system allows for usage in a greater variety of environmental conditions. This combination, plus its superior durability, makes it suitable for a wide range of installations and applications.

Assurance of Long-Term Dependability

A variety of system management functions ensure safe, dependable, long-term use in professional applications. These include:

- Three modes to manage and counteract image shadowing. While all PDPs are subject to image shadowing, but the PDP-433CMX has three special modes to manage and counteract it.
 1. Linear Brightness mode decreases the peak intensity of high-brightness images.
 2. Orbiter mode incorporates one-pixel-at-a-time movement of displayed images at fixed intervals.
 3. Inverse mode displays images as negative.
- **Peak Pattern Detection System**
This system also helps to prevent shadowing by monitoring the prolonged display of still images and the concentration of brightness in any segment of the panel. * Even so, displaying the same still images for long periods should be avoided as image shadowing or burn-in may occur.
- **Smart Cooling System**
Internal fans are activated only when needed, keeping fan noise to a minimum and conserving power.

WHQL Compatibility and Easy Operation

Pioneer's plasma displays are the industry's first to receive the Windows Hardware Qualification Labs(WHQL) certification of compliance. The PDP-433CMX continues this tradition by providing Plug & Play drivers to support Microsoft® Windows® and other operating systems. This is a display you can use with confidence. *Compatible with Microsoft Plug & Play (VESA DDC 1/2B) An Auto Setup function allows automatic screen adjustment with a single touch via the remote control when inputting a wide variety of computer signal types. To provide more punch into presentations, there's a Point Zoom function that lets you instantly expand any portion of the image to four different sizes.



Environmentally Friendly

All plastic parts are made of halogen-free material rather than the halogen type fire-resistant materials generally believed to be a source of dioxins during incineration. Metal parts have chrome-free plating wherever possible; we strive to minimize the use of chrome to protect the environment and those who live in it.

Additional Features Installers, System Integrators and End Users Will Appreciate

- Integrator mode permits precise white balance adjustment, as well as control of various functions such as the Off Timer, Mask Generator, Mirror Mode, OSD Management, IR/key Pad Lock-out, Unit Identification number/naming, Input naming, Color Temperature, Power Management, Baud Rate selection and many other features.
- Bi-directional RS-232C external control interface and combination terminals permit central control and management of several units.
- 2 x 2 Mode allows 2 x 2 multi-expansion display (similar to video wall) without an expansion device.
- Reporting of operational parameters and the device status has been significantly enhanced. With this communication capability, direct or remote diagnostics as well as control are now much easier.

Expansion Possible for A Wide Range of Uses

An Expansion Slot offers open architecture to further expand digital and analog capabilities for customized business applications. Please ask your dealer or contact Pioneer for more information.

Dimensions

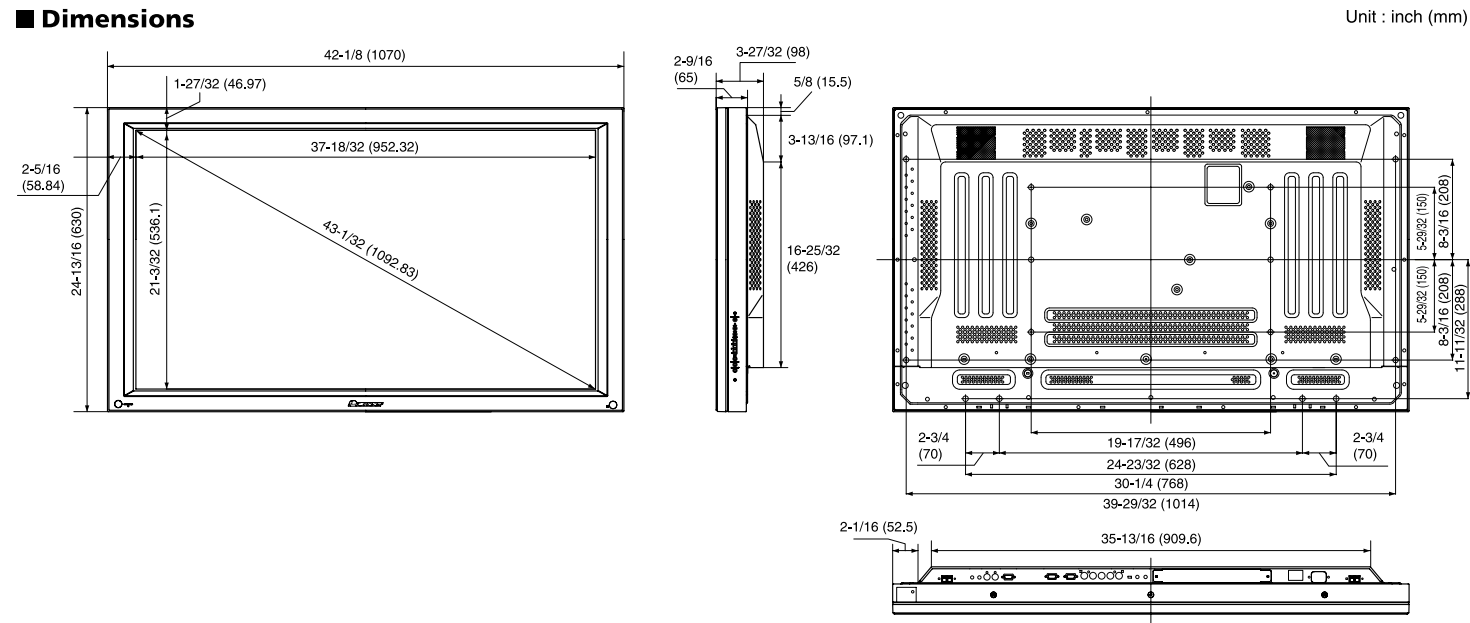

Terminal Configuration



Specifications

Effective Screen Size (W x H)	37-15/32" x 21-3/32" (952.32 x 536.1 mm) (43in. Diag.)
Aspect Ratio	16:9
Number of Pixels	1024 (Hor.) X 768 (Ver.)
Pixel Pitch	0.930 mm (Hor/RGB trio) x 0.698 mm (Ver.)
Viewing Angle	More than 160° (Hor.), more than 160° (Ver.)
Dimensions (W x H x D)	42-1/8" x 24-13/16" x 3-27/32" (1070 x 630 x 98 mm)
Weight	69 lbs. 7 oz (31.5 kg)
Power Consumption	298W (0.9W at stand by)
Power Requirements	AC 100-120V ± 10%, 50/60Hz (2.98-2.48A)
Operating Temperature	32°F- 104°F (0°C-40°C)
Operating Humidity	20%-80%
Operating Atmospheric Pressure	800-1100 hPa
Safety Regulations	UL 1950, FCC 15B classB, C-UL

Input/Output Terminals

INPUT 1	IN	Connector	Signal	Level/Impedance
		Mini D-sub 15-pin	RGB signal	RGB : 0.7Vp-p/75 Ω
			(G on Sync compatible)	G on Sync : 1Vp-p/75 Ω
*Compatible with Microsoft Plug & Play (VESA DDC 1/2B)				
	OUT	Mini D-sub 15-pin	RGB signal	75 Ω
			(G on Sync compatible)	
INPUT 2	IN	BNC x 5	RGB signal	RGB : 0.7Vp-p/75 Ω
			(G on Sync compatible)	G on Sync : 1Vp-p/75 Ω
HD/CS,VD : TTL level/75 Ω or 2.2k Ω switchable				

Audio Input/Output Terminals

	Connector	
AUDIO INPUT (INPUT 1/2)	IN	Stereo mini
AUDIO OUTPUT	OUT	Stereo mini
L/R : 500mVrms/more than 10k Ω		
L/R : 500mVrms/less than 5k Ω (FIX)		
L/R : 0-500mVrms/less than 5k Ω (VARIABLE)		
SPEAKER	OUT	
L/R : 8-16 Ω/2W + 2W (8 Ω)		

Control Terminals

RS-232C	Connector	D-sub 9-pin
(for control of computer)	Baud Rate	1200, 2400, 4800, 9600, 19200, 38400 bps
Combination IN/OUT	Connector	Mini-DIN 6-pin (x2)
Control IN/OUT	Connector	Mini jack (x2)

Computer Input Signal

Resolution (Dot x Line)	Vertical Frequency	Horizontal Frequency	Usage
640 x 400	56.4Hz	24.8kHz	NEC PC-9800
	70.1Hz	31.5kHz	NEC PC-9800
	60Hz	31.5kHz	(852 x 480) (864 x 480)
640 x 480	66.7Hz	35kHz	Apple Macintosh 13"
	72Hz	37.9kHz	
	75Hz	37.5kHz	
	85Hz	43.3kHz	
	56Hz	35.2kHz	
	60Hz	37.9kHz	
	72Hz	48.1kHz	
800 x 600	75Hz	46.9kHz	
	85Hz	53.7kHz	
	74.6Hz	49.7kHz	Apple Macintosh 16"
	60Hz	31.7kHz	
	60Hz	48.4kHz	
	70Hz	56.5kHz	
	75Hz	60kHz	() indicates Apple Macintosh 19"
1152 x 864*	85Hz	68.7kHz	
	60Hz	53.7kHz	
	72Hz	64.9kHz	
	75Hz	67.7kHz	
	75.1Hz	68.7kHz	Apple Macintosh 21"
1152 x 900*	66Hz	61.8kHz	Sun Microsystems LO
	76Hz	71.7kHz	Sun Microsystems HI
	56Hz	45.1kHz	
	60Hz	48.4kHz	
1280 x 768	70Hz	55.5kHz	
	60Hz	60kHz	
	60Hz	64kHz	
	75Hz	80kHz	
1280 x 960*	85Hz	91.1kHz	
	60Hz	75kHz	
	65Hz	81.3kHz	
	70Hz	87.5kHz	
	75Hz	93.8kHz	
1600 x 1200*	85Hz	106.3kHz	
	60Hz	75kHz	
	65Hz	81.3kHz	
	70Hz	87.5kHz	

*Compressed or partial display

Accessories

- Power Cord x 1 • Cleaning Cloth x 1 • Speed Clamp x 2 • Bead Band x 2 • Remote Control Unit x 1 • Remote Control Unit Case x 1
- AA (R6) Battery x 2 • Display Stand x 2 • Hex Hole Bolt (M8 x40) x 2 • Washer x 2 • CD-ROM x 1 • Operation Instructions
- Caution Sheet • Warranty Card

Notice

- This equipment is sold on the condition that it will be installed by a competent professional engineer with sufficient training and skill to carry out proper installation. Be sure to entrust the installation and setup of this machine only to a competent professional or retail service engineer.
- Pioneer cannot accept liability in case where the equipment is damaged due to inappropriate installation location, improper assembly, installation, set-up, operation or renovation, or by natural disasters.

Optional Video Card PDA-5002

This Card allows Video, High Definition and Digital RGB inputs.



Video Input/Output Terminals

Composite video signal: Input (BNC) x 1 Output (BNC) x 1

Y/C separate video signal: Input (S-terminal) x 1

Digital RGB Input Terminals (DVI standard)

Digital RGB signal: Input (DVI-D 24-pin) x 1

Individual resolution of (VGA, SVGA, XGA, SXGA) should apply to a vertical frequency of 60Hz.*

* Not compatible with copy protection (HDCP)

Audio Input Terminals

Audio signal: L/R Input (pin x 2) x 2

Optional Side-Mount Speakers PDP-S07-LR

2-way speakers with a dome tweeter and a newly designed perpendicularly installed oval unit. These speakers are compact, yet deliver wide-range performance.



Maximum output: 12W/8 ohms

Dimensions (WxHxD): 2-29/32" x 24-13/16" x 3-31/32" (74 x 630 x 101 mm)

Weight: 3 lbs. 8 oz (1.6 kg.) (one unit)

OPTIONS

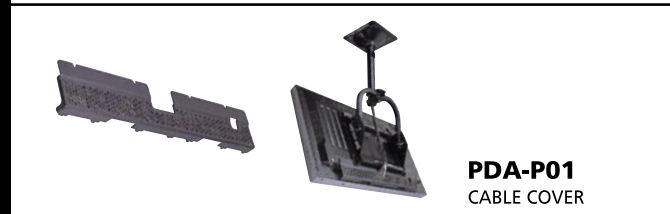
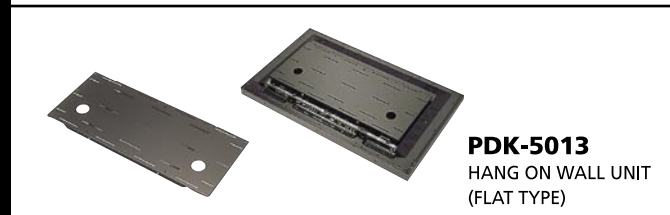
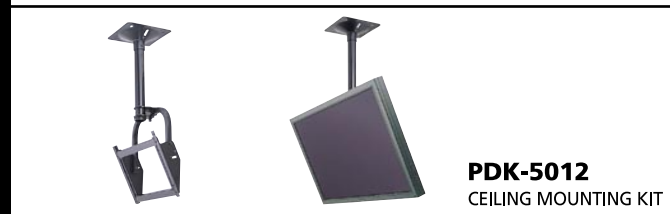
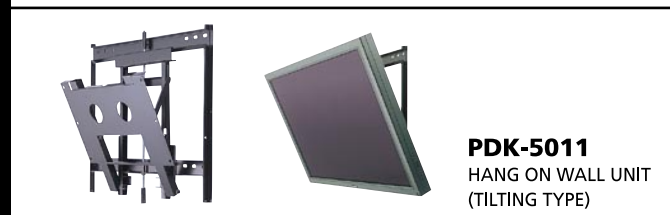

*Only available as special order in the U.S.A.

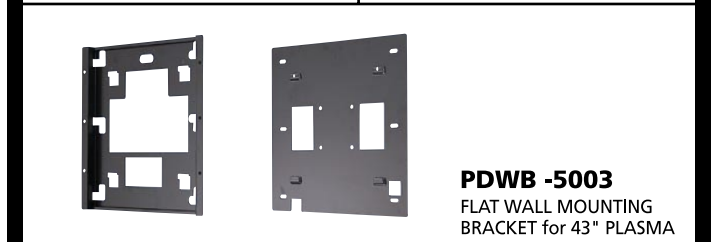
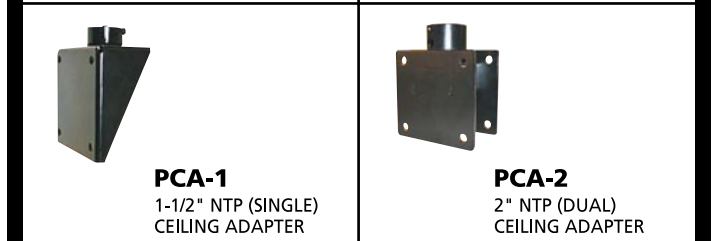
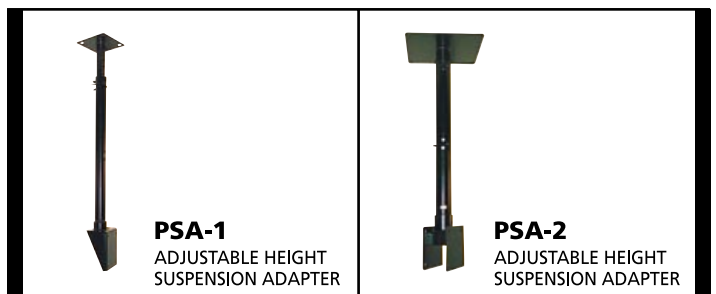

*These products are offered for sale only in the US market. Pioneer cannot accept responsibility in the event that they are used in other regions.

*These items have been produced by Progressive Marketing Products, Inc. If you need further information please call 1-800-368-9700 or access to <http://www.pmpi.com>.

Ideal for a Wide Range of Uses

Pioneer Plasma Displays are designed to meet a wide variety of application requirements.

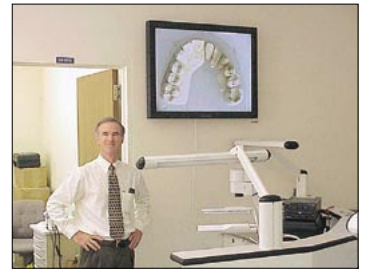

50-inch XGA Professional Plasma Display **PDP-503CMX**

- 1,280 x 768 pixels, true XGA display.
- Pioneer's unique Deep Encased Cell Structure achieves unprecedented high brightness and finely detailed pictures.
- Pure Color Filter provides high contrast, accurate color reproduction and ambient light management.
- Advanced Continuous Emission Display Technology improves gradation in the low brightness range.
- Lowest power consumption (380W) in the 50-inch XGA class.

Dimensions (WxHxD): 47-15/16" x 28-1/8" x 3-27/32"
(1218 x 714 x 98 mm)

Weight: 85 lbs. 12 oz (38.9 kg)



Pioneer Corporation and the Shizuoka Pioneer Corporation where PDP products are developed have both achieved ISO 14001 certification.

*For more details, contact one of the addresses below. *All product names and company names are registered trademarks of their respective owners.

Visit our websites:

- PIONEER CORPORATION URL : <http://www.pioneer.co.jp/>
- PIONEER ELECTRONICS (USA) INC. URL : <http://www.pioneerelectronics.com/>

Pioneer

PIONEER CORPORATION

4-1, Meguro 1-chome, Meguro-ku, Tokyo 153-8654, Japan TEL : 81-3-3495-6729 FAX : 81-3-3490-2785

PIONEER ELECTRONICS (USA) INC.

2265 East 220th Street, Long Beach, CA 90810, USA TEL : 310-952-2000 FAX : 310-952-2639

PIONEER HIGH FIDELITY TAIWAN CO., LTD.

13FL No. 44 Chung Shan North Road Sec.2. Taipei, Taiwan TEL : 886-2-2521-3588 FAX : 886-2-2511-4888



Printed on Recycled Paper

4101B K-F(F)02-02 Printed in Japan