

RDS AV RECEIVER
AUTORADIO MULTIMÉDIA RDS
AV RECEPTOR RDS

MVH-AV251BT



Quick start guide
Guide de démarrage rapide
Guía de inicio rápido

English

This guide is intended to guide you through the basic functions of this unit.
For details, please refer to the Operation manual stored on the website.
<http://www.pioneerelectronics.com/PUSA/Car>



Français

Ce guide est destiné à vous guider dans les fonctions de base de cet appareil.
Pour les détails, veuillez vous reporter au Mode d'emploi disponible sur le site Web.
<http://www.pioneerelectronics.com/PUSA/Car>



Español

Esta guía tiene como fin explicar las funciones básicas de esta unidad.
Para obtener más información, consulte el manual de operaciones que se encuentra en el sitio web.
<http://www.pioneerelectronics.com/PUSA/Car>



Notepad / Bloc-notes / Bloc de notas



Selecting the source

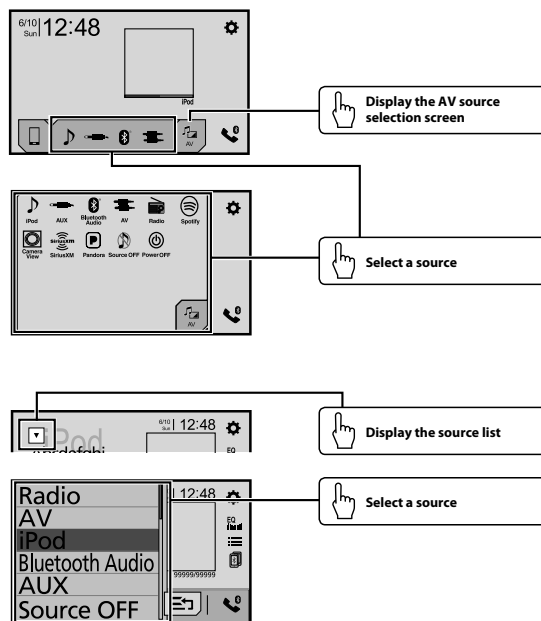

Setting the clock

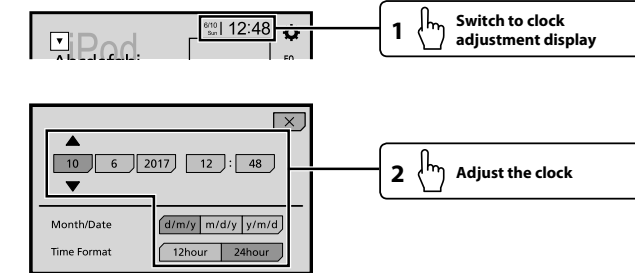

Tuner operation

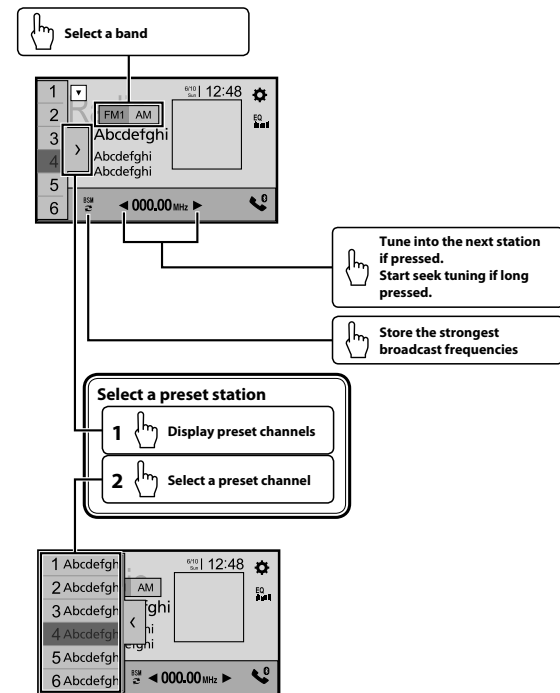

Moving images operation

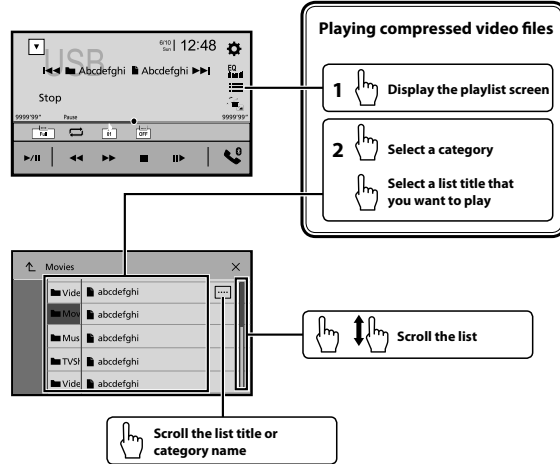

Audio operation

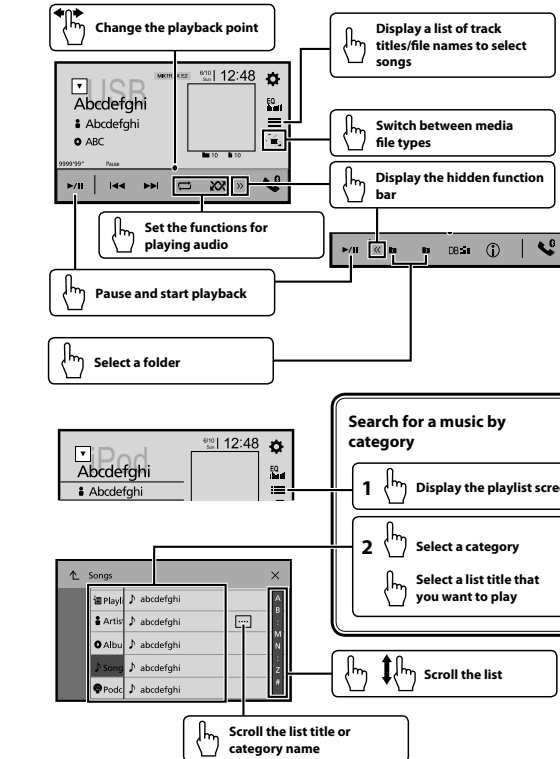

Bluetooth telephone operation

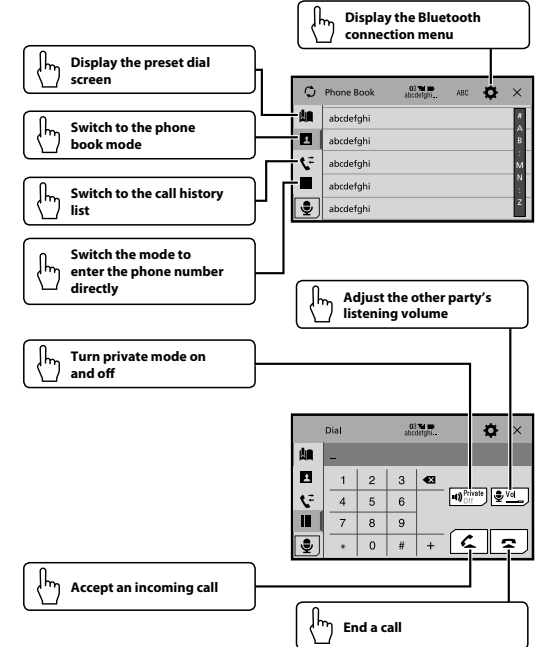

What's What

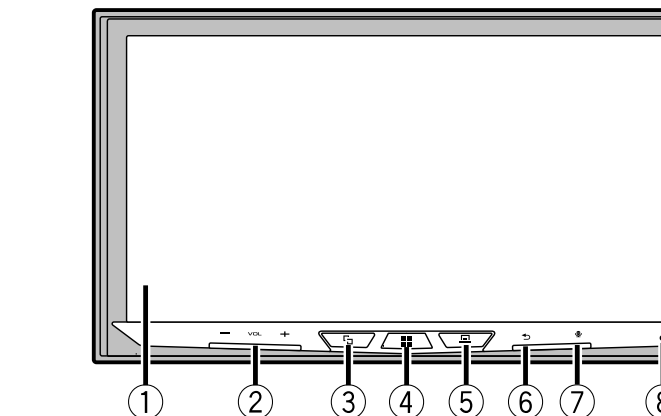

- 1 LCD screen
- 2 VOL (+/-) button
- 3 Application button
To switch between the Application screen and the AV operation screen. Press and hold to switch to the camera view mode.
- 4 Menu button
To display the top menu screen. Press and hold to power off.
- 5 Power button
To display the menu bar. Press and hold to mute or unmute.
- 6 Home button
To display the top menu screen or back to previous screen. Press and hold to turn off the display.
- 7 Home button
When the display is turned off, touch the screen to revert to the original screen.
- 8 RESET button

: Toucher : Toucher et glisser

Sélection de la source

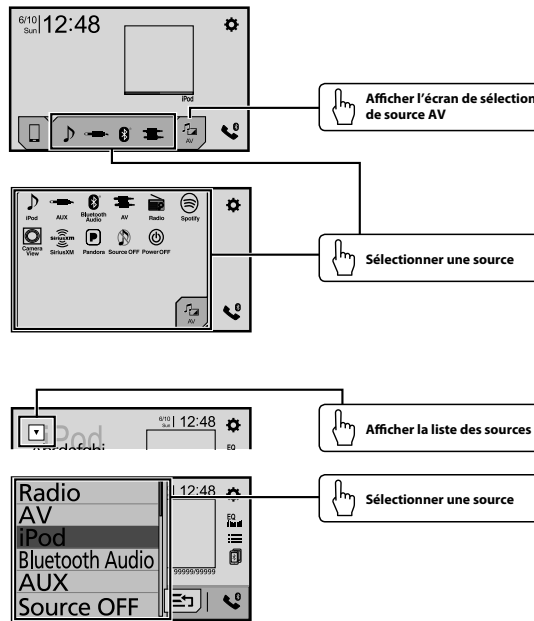

Réglage de l'horloge

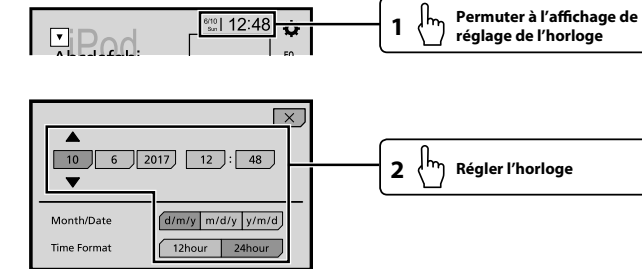

Utilisation du sintoniseur

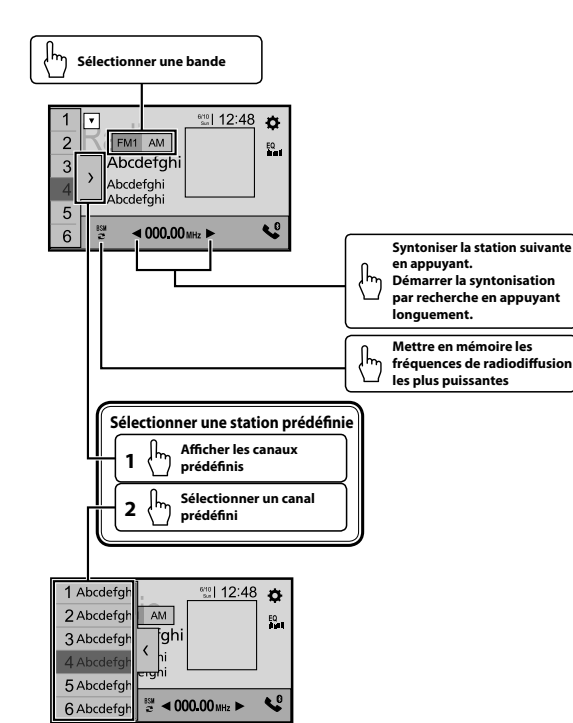

Utilisation des images en mouvement

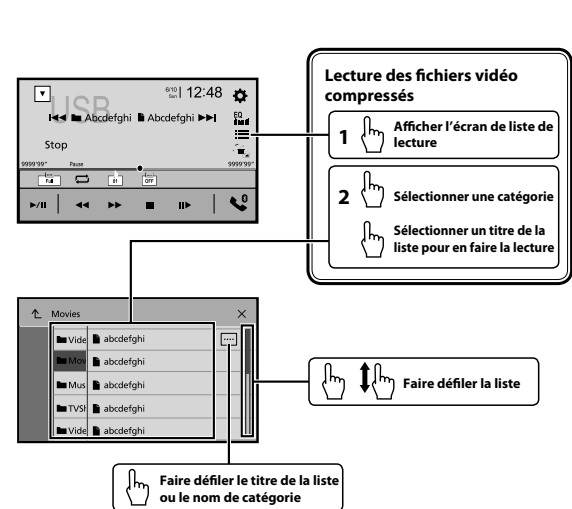

Utilisation des fonctions audio

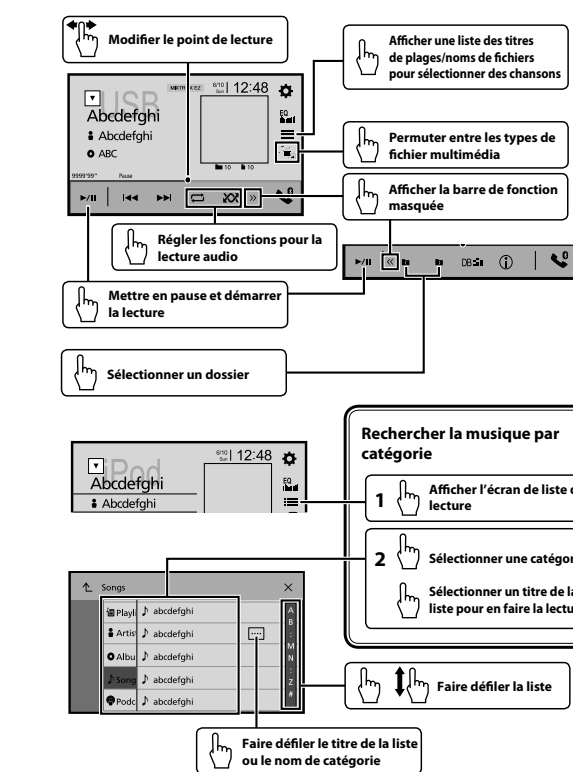

Utilisation d'un téléphone Bluetooth

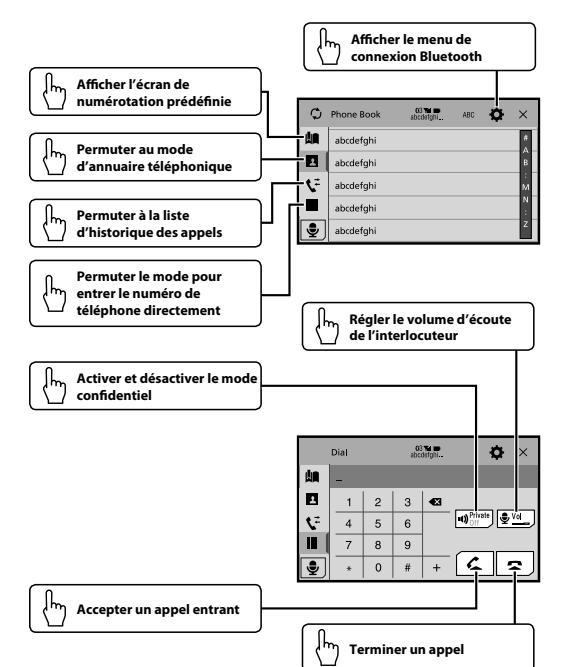

Description de l'appareil

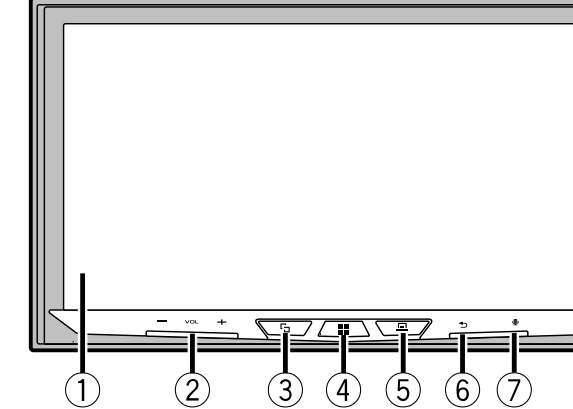

- 1 Écran LCD
- 2 Touche VOL (+/-)
- 3 Touche
- 4 Touche
- 5 Touche
- 6 Touche
- 7 Touche
- 8 Touche RESET

Pour commuter entre l'écran Application et l'écran de commande AV. Maintenez enfoncée pour commuter au mode d'image de la caméra.

Pour afficher l'écran de menu supérieur. Maintenez enfoncée pour éteindre.

Pour afficher la barre de menus. Maintenez enfoncée pour couper ou réactiver le son.

Pour afficher l'écran de menu supérieur ou pour revenir à l'écran précédent. Maintenez enfoncée pour éteindre l'afficheur.

□ Lorsque l'afficheur est éteint, touchez l'écran pour revenir à l'écran d'origine.

Pour activer le mode de reconnaissance vocale tel que Siri® lorsqu'un iPhone® est connecté à l'appareil par Bluetooth ou USB.



Seleccionar la fuente

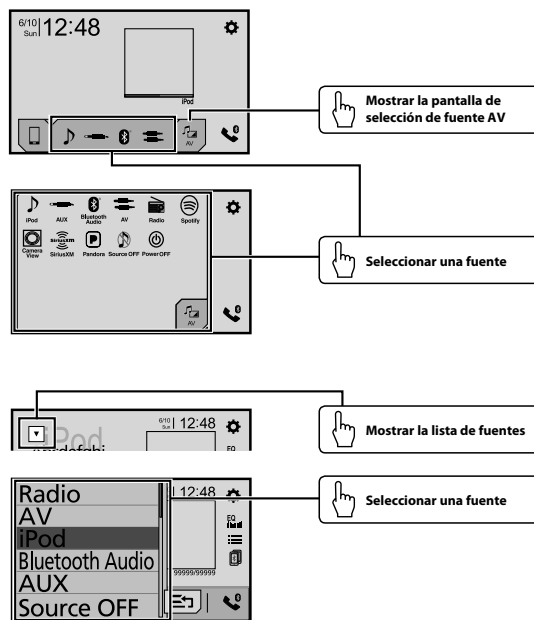

Configurar el reloj

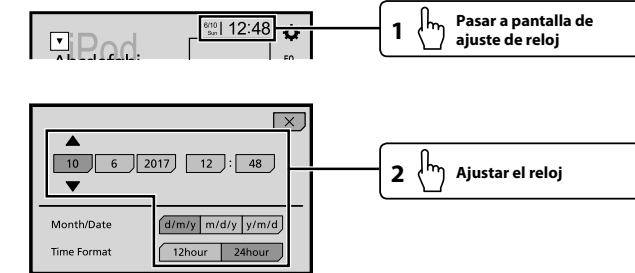

Uso del sintonizador

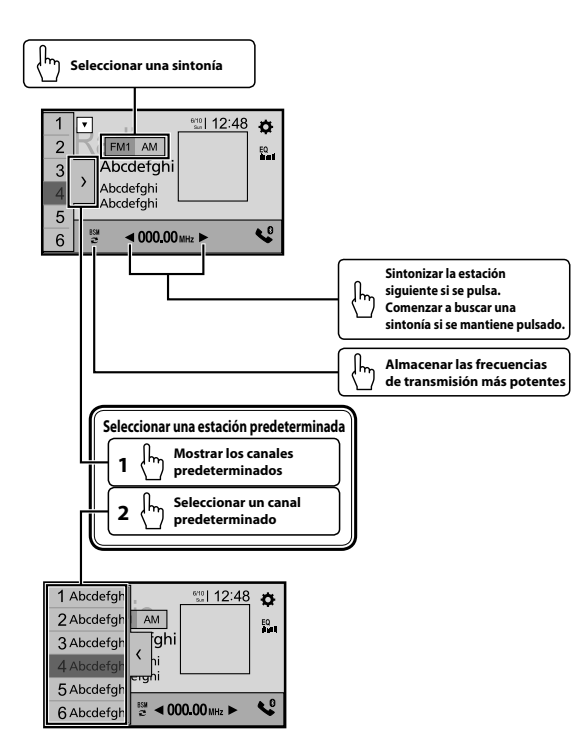

Uso de imágenes en movimiento

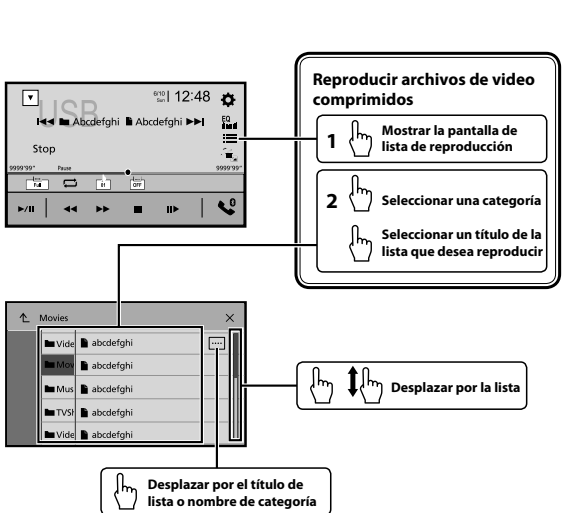

Uso de audio

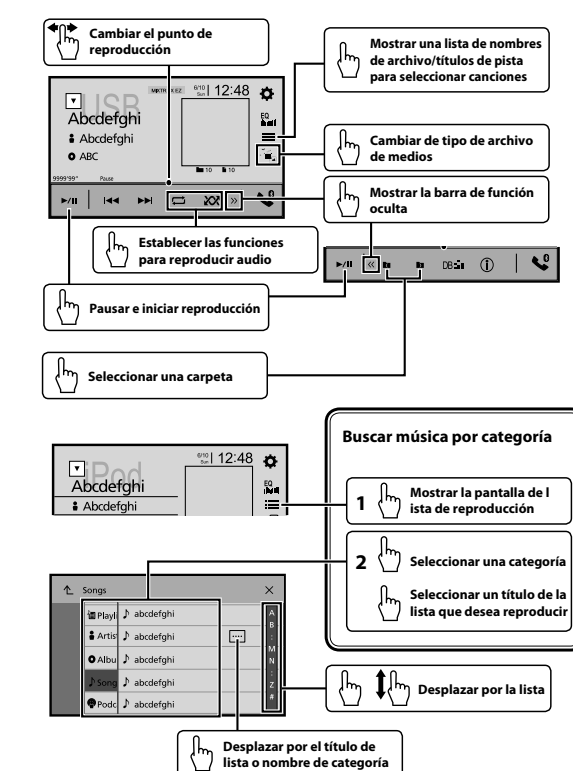

Uso de teléfono Bluetooth

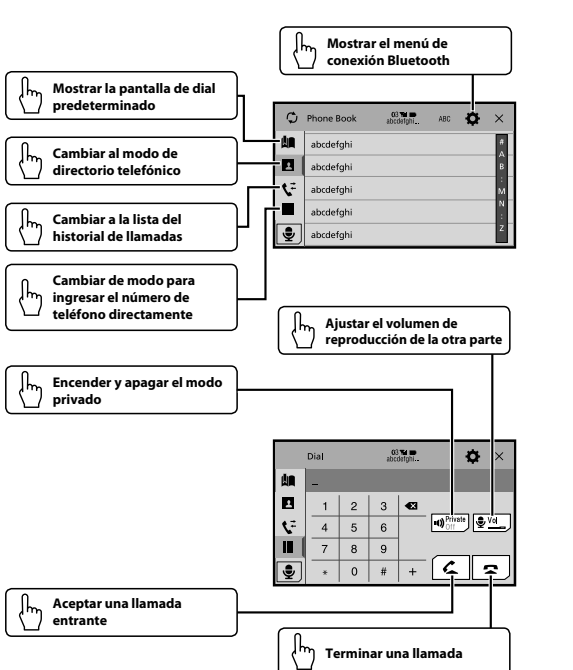

Qué es que

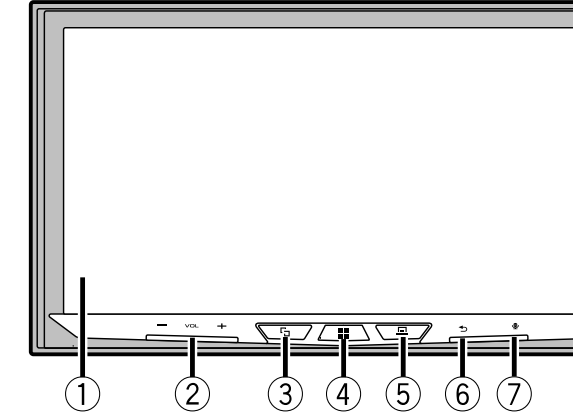

- 1 Pantalla LCD
- 2 Botón VOL (+/-)
- 3 Botón Para cambiar entre la pantalla de Aplicación y la pantalla de uso de AV. Mantenga pulsado para cambiar al modo de vista de cámara.
- 4 Botón Para mostrar la pantalla del menú superior. Mantener pulsado para apagar.
- 5 Botón Para mostrar la barra de menú. Mantener pulsado para silenciar o activar el sonido.
- 6 Botón Para mostrar la pantalla del menú superior o para regresar a la pantalla anterior. Mantener pulsado para apagar la pantalla.
- 7 Botón Para activar el modo de reconocimiento de voz, como Siri®, cuando conecta un iPhone® a la unidad a través de Bluetooth o USB.
- 8 Botón RESET