



Dolby Atmos[®] Home Theater Installation Guidelines

September 2014

Contents

1. Background on Dolby Atmos
2. General Dolby Atmos Home Setup Guidelines
 - Dolby Atmos Home Playback
 - Dolby Atmos Home Theater Speaker Options
 - Overhead Speakers
 - Alternatives to Overhead Speakers
 - Dolby Atmos Enabled Speakers
 - Use of Existing Speakers
 - Combination: Overhead and Dolby Atmos Enabled Speakers
 - Use of Existing Overhead Speakers
3. Standard Speaker Configurations
 - Dolby Conventions for Speaker Configurations
 - Standard Setup for Both Overhead Speakers and Dolby Atmos Enabled Speakers
4. Additional Speaker Placement Guidelines
 - Listener-Level Speaker Placement Guidelines
 - Overhead/Height Speaker Placement Guidelines
5. Dolby Surround Upmixer

1. Background on Dolby Atmos

Many leading Hollywood movies, including recent Academy Award® winning films, are presented in Dolby Atmos®, as this revolutionary sound technology allows filmmakers unprecedented realism and creative freedom. With Dolby Atmos, content creators can precisely place and move sounds almost anywhere, including overhead, to create a multidimensional listening experience.

Dolby Atmos technology is now available for the home and will produce a multidimensional listening experience never before experienced in a home theater. And you'll get a great immersive experience, no matter what kind of Dolby Atmos home theater setup you have. Dolby Atmos content is mixed as audio objects instead of traditional channels. This means the content is not tied to any specific playback configuration. Further, the technology automatically adapts the object audio to take full advantage of the number and placement of your speakers, from systems with five speakers on the floor and two speakers producing overhead sound to a Dolby Atmos system with as many as 24 speakers on the floor and 10 overhead speakers.

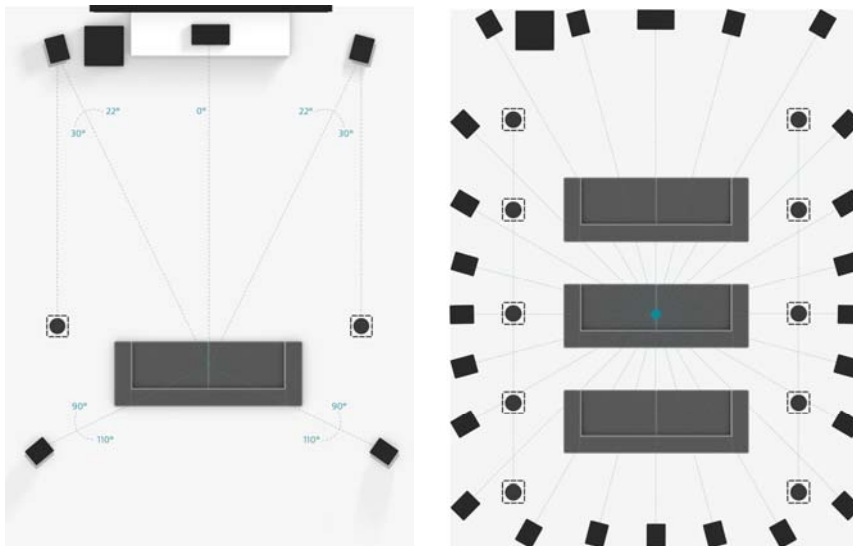

Figure 1: At left is a Dolby Atmos system with five speakers on the floor and two overhead speakers; at right is a Dolby Atmos system with up to 24 speakers on the floor and 10 overhead speakers.

Additionally, a new Dolby surround upmixer allows for legacy channel-based content that has not been mixed for Dolby Atmos to be expanded to fill the flexible speaker layouts of a Dolby Atmos system.

These installation guidelines are intended to be a resource for integrating Dolby Atmos into a home theater system and unlocking the potential of this revolutionary audio format. Details include use of conventional overhead speakers and Dolby Atmos enabled speaker technology, which enables you to architect a system capable of reproducing overhead sound, even if you're not able to put speakers in or on a client's ceiling.

2. General Dolby Atmos Home Setup Guidelines

The following components are needed to set up a Dolby Atmos home theater system.

1. A source device to play Dolby Atmos content. Many existing devices will work.
2. A Dolby Atmos capable A/V receiver (AVR) or processor unit.
3. Speakers to reproduce overhead or height audio.
4. Speakers to reproduce listener-level audio. Note: In many use cases, the customer's existing speakers may be employed in a Dolby Atmos home theater.¹

Dolby Atmos Home Playback

Source device options to play or stream content

To experience this sound revolution, you'll need a way to play or stream Dolby Atmos content. There are two initial pathways into the home theater:

1. You can play Dolby Atmos content encoded on a Blu-ray Disc™ through an existing Blu-ray Disc player. Be sure you have a recent player that's fully compliant with Blu-ray™ specifications.²
2. You can stream Dolby Atmos content from a compatible game console, Blu-ray, or streaming media player.

In both cases, be sure to set your player to bitstream output and ensure secondary audio functionality is disabled. Connect to your AVR using an HDMI® connection.³

Dolby Atmos capable AVR or processor

You'll be able to assemble a system from a wide range of available A/V components, starting with an AVR or pre-processor that supports Dolby Atmos decoding and rendering. Leading AVR manufacturers are introducing products that support Dolby Atmos playback for the home.

¹ With the exception of the center and center surround speakers, all speakers in a Dolby Atmos playback system (listener level, overhead, Dolby Atmos enabled) must be added in pairs.

² You will not need to replace your Blu-ray player as long as it fully conforms to the Blu-ray specification. Current-generation Blu-ray players, and most recent players, are compatible. You should check with the Blu-ray player manufacturer if you encounter problems.

³ Decoding and rendering of Dolby Atmos content is managed entirely by the AVR. To properly pass the Dolby Atmos audio to the AVR, source devices must be connected to the AVR via HDMI 1.4 or later and set to audio bitstream out. For Blu-ray players, the secondary audio mixing option must be disabled.

AVR connection and setup

Most AVRs that support Dolby Atmos have speaker connections labeled HEIGHT, as shown in Figure 2. Some AVRs do not use the HEIGHT label for all capable channels, but they instead allow you to assign specific terminals for the height speaker outputs through the graphical user interface in the setup menu. Connect overhead speakers or Dolby Atmos enabled speakers to those height-capable outputs.



Figure 2: Rear panel of AVR; the height speaker connections are at right.

If you're using four overhead or Dolby Atmos enabled speakers (or think you might add these in the future), you will need an AVR capable of four height outputs.

Most AVRs will require the user to set up the AVR through the user interface, or microphone detection, in order to inform it as to the specific speaker type and specific speaker locations being employed in the room playback configuration. Ensure this step is completed so that Dolby Atmos audio objects are accurately placed using the available speakers.

Bass management settings should also be set correctly to correspond to the speaker capabilities in the system.

Note: A Dolby Atmos playback system may consist of dedicated overhead speakers, Dolby Atmos enabled speakers, or a hybrid of both. Be sure to keep in mind the low frequency extension of each speaker in the layout when calibrating and setting up bass management.

Dolby Atmos Home Theater Speaker Options

The dimension of height—hearing sounds coming from above you—is key to the multidimensional Dolby Atmos experience. Reproducing overhead sounds requires new thinking about home theater design.

You have several different speaker options for a Dolby Atmos home theater system, and you will not likely have to replace all of your current speakers to build out a Dolby Atmos system.

Many installations currently have systems with a subwoofer and either five or seven speakers positioned at about ear level. These speakers are referred to as the “listener level” in this document. Any speaker type that is capable of accurately representing a stereo pan is suitable to reproduce objects.

As in the past, the placement of all listener-level speakers should follow these recommendations, which are based on ITU-R BS.775-3:

- The speakers located in the front of the room shall be used as a reference point. All speakers in the listener plane should ideally be equidistant from the listener position. If this is not possible, compensating for distance may be used to time align the arrival of audio from each speaker to the listener.
- All listener speakers should be at the same height, typically 3.9 feet (1.2 meters), which is ear level for the average seated listener (as defined in ITU-R BS.1116-1).

If possible, the height of the rear speakers should be the same as the height of the front speakers. If the room design makes this impractical, or impossible, the rear speakers may be higher than the front speakers. However, it is suggested that the height of the rear speakers should not be more than 1.25 times the height of the front speakers.

Overhead Speakers

Overhead sound is a vital part of the Dolby Atmos experience. There are a variety of options for adding this capability to a room.

One solution is to install speakers overhead. Most high-power, full-frequency conventional overhead speakers with wide dispersion characteristics will work in a Dolby Atmos home theater.

Characteristics

Dolby Atmos audio is mixed using discrete, full-range audio objects that may move around anywhere in three-dimensional space. With this in mind, overhead speakers should complement the frequency response, output, and power-handling capabilities of the listener-level speakers. Choose overhead speakers that are timbre matched as closely as possible to the primary listener-level speakers. Overhead speakers with a wide dispersion pattern are desirable for use in a Dolby Atmos system. This will ensure the closest replication of the cinematic environment, where overhead speakers are placed high above the listeners.

Mounting considerations

If the chosen overhead speakers have a wide dispersion pattern (approximately 45 degrees from the acoustical reference axis over the audio band from 100 Hz to 10 kHz or wider), then speakers may be mounted facing directly downward. For speakers with narrower dispersion patterns, those with aimable or angled elements should be angled toward the primary listening position.

Room treatment considerations for use of overhead speakers

For optimal performance, the overhead speakers should be at least two times the height of the listener's ear level (this generally applies to on-ceiling speakers, which may be installed lower than the actual ceiling height).

Sound-absorbing and sound-diffusing treatment for handling reflections from the walls, floor, and ceiling are recommended to improve sound quality and reduce unwanted audio reflection.

Alternatives to Overhead Speakers

Installing overhead speakers may not be possible or desirable for your client. Installing speakers overhead and running the necessary wiring can be expensive and time consuming. If your client rents the home, the property owner may not allow it. And if the ceiling is made of a material such as concrete or brick, installing speakers overhead may not be possible. Finally, your client may not like the look of overhead speakers.

Dolby Atmos Enabled Speakers

Through our knowledge of psychoacoustics and sound physics, we've developed speakers that can create overhead sound even though they're only a few feet off the floor. Dolby specifies filtering characteristics for these speakers that amplify the perception of sound originating overhead. Employing a predetermined angle of incidence in the speaker cabinet, the speakers direct sound upward, where it reflects off the ceiling to produce an incredibly accurate and lifelike recreation of overhead sound. The performance of Dolby Atmos enabled speakers must be experienced to be believed.

Integrated speakers

You will be able to select integrated Dolby Atmos enabled speakers that include both traditional forward-firing speakers and upward-firing speakers in a single speaker cabinet. (Those speakers have two sets of speaker binding posts, one for the traditional speaker and one for the upward-firing Dolby Atmos enabled speaker.)

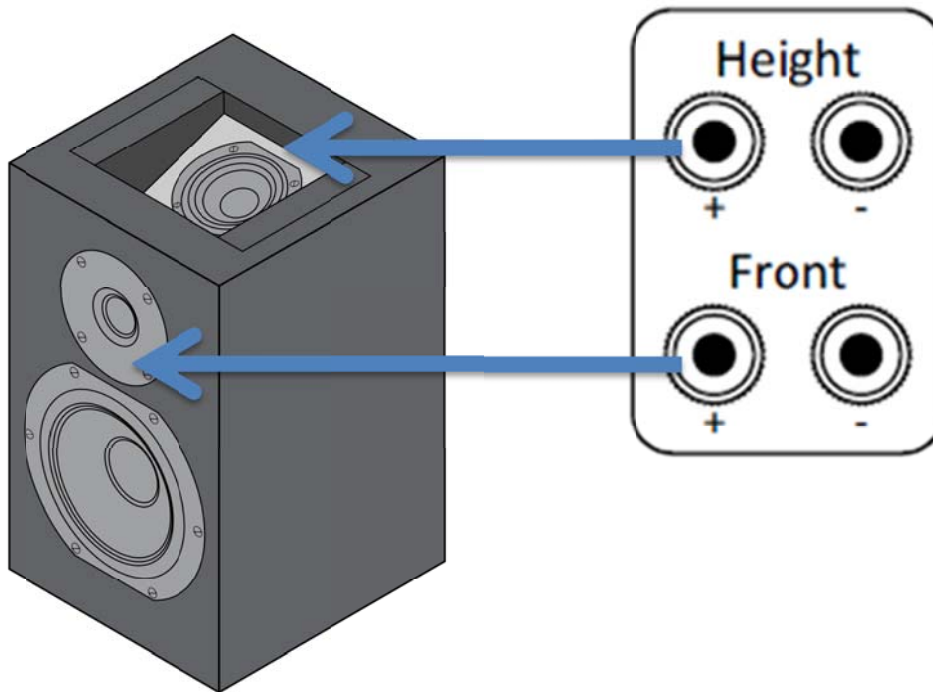

Figure 3: Dolby Atmos enabled integrated speakers include both traditional front-firing speakers and upward-firing speakers. Both sets of speakers have their own binding posts to connect to your AVR.

Add-on modules

If your client already has conventional speakers they prefer to maintain, one option is to install Dolby Atmos enabled add-on speaker modules. These modules include only the upward-firing speakers. You can place the add-on modules on top of the current speakers or nearby on another surface. Note: To insure optimum performance, be sure to employ proper bass management when installing and calibrating Dolby Atmos enabled integrated speakers and independent modules in your client's system. Typically, these speakers are not full range. Please refer to the section on bass management later in this document.

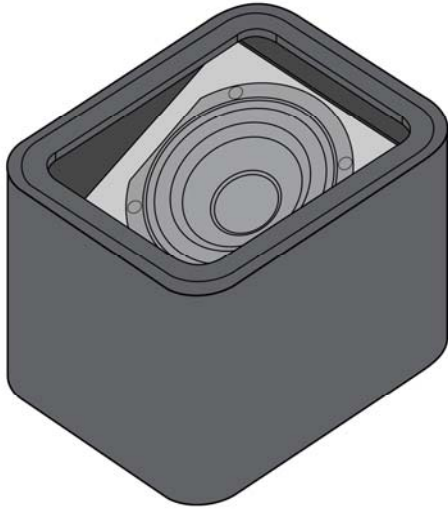

Figure 4: Dolby Atmos enabled add-on modules include only upward-firing speakers. You can place them on top of your traditional front-firing speakers or on another surface near them.

Comparison to overhead speakers

Dolby Atmos enabled speakers produce slightly more diffuse overhead audio that is quite lifelike and, in some cases, may be preferable to the sound that originates from overhead speakers.

If your ceiling is low or you have to mount your loudspeakers on overhead trusses or brackets, overhead speakers may be too close to you as you listen. The audio may be distracting because you'll hear, directionally, what each speaker is producing instead of feeling immersed in an atmosphere in which sounds occur naturally overhead.

In this environment, Dolby Atmos enabled speakers may be a better solution for reproducing the height plane of sound you would hear in a cinema, where the overhead speakers are located high in the auditorium, and are naturally creating a more diffuse experience. Audio mixers and experts who have auditioned Dolby Atmos enabled speakers agree that the sound these speakers produce can be preferable to the sound of dedicated overhead speakers.

Dolby Atmos enabled speaker positioning

Dolby recommends installation of four Dolby Atmos enabled speakers whenever possible. Use of four speakers will make the placement of overhead sounds more accurate, and you'll get more precise, realistic sounds when an object, such as a helicopter, passes overhead. Two of the speakers (whether they are integrated

speakers or add-on modules) should be in the front left and front right speaker locations of your system. The other two should be positioned in the surround sound speaker locations, ideally at the rear surround speakers, if you have them.

If using only two Dolby Atmos enabled speakers, place the Dolby Atmos enabled speakers at the front left and front right speaker locations. Note: With the exception of the center and center surround speakers, all speakers in a Dolby Atmos playback system (listener level, overhead, Dolby Atmos enabled) must be added in pairs. Dolby Atmos speakers should be located in the front left and right and left rear surround and right rear surround locations in a 7.1.4 playback system.

Placement height

For optimal effect and to minimize direct radiating audio at listener level, place Dolby Atmos enabled speakers at or slightly above the height of your ears when seated. Avoid placing the Dolby Atmos enabled speakers higher than one-half the height of your wall.

Placement relative to listeners

To avoid an unwanted proximity effect, make sure the speakers are at least 3 feet (0.9 meter) away from listening positions, ideally 5 feet (1.5 meters) or more. This distance may potentially be less if the upward-firing driver(s) of the Dolby Atmos enabled speaker is placed well above the level of the closest listener's head.

Positioning of add-on modules

If you're using add-on modules, place them either on top of your front and surround (ideally, rear surround) speakers or within 3 feet (0.9 meter) of those speakers. Dolby Atmos enabled speakers should be mounted horizontally so that the driver is facing toward the ceiling.

Room treatment considerations for use of Dolby Atmos enabled speakers

For optimal performance, the ceiling should be flat (not angled or vaulted), with a height of 14 feet (4.27 meters) or less, and made of an acoustically reflective material (drywall, plaster, hardwood, or another rigid, non-sound-absorbing material). The ideal ceiling height is between 8 and 12 feet (2.44 and 3.66 meters).

Sound-absorbing and sound-diffusing treatment for handling unwanted reflections from the walls and floor is recommended to improve sound quality and system performance. When using Dolby Atmos enabled speakers, first audio reflection from

the ceiling is desired; audio reflections from elsewhere within the room should be avoided.

Bass management with Dolby Atmos enabled speakers

Be mindful to employ proper bass management when installing Dolby Atmos enabled speakers in the customer's system. Typically, these speakers are not full range, and manufacturer documentation should be consulted for specific details on each model. Integrated speakers may direct low frequencies intended for the elevation drivers to the primary speakers; in other instances, including when modules are employed, you will have to perform bass management in the AVR or pre-processor.

Use of Existing Speakers

Most existing speakers within current home theaters will work for Dolby Atmos playback. Floor-standing, stand-mounted, on-wall, and in-wall speakers that currently produce audio at the listener level can be complemented with overhead speakers and/or Dolby Atmos enabled speakers to generate the height plane of overhead sounds. If the AVR or pre-processor supports them, more speakers may also be added at listener level to add greater precision to object audio placement and movement. With the exception of the center and center surround speakers, all speakers must be added in pairs in a Dolby Atmos playback system.

Front height mounted speakers

Most AVRs will support the use of front height (Dolby® Pro Logic® IIz) mounted speakers with Dolby Atmos playback; however, Dolby recommends the use of either overhead or Dolby Atmos enabled speakers to create the most lifelike and enveloping audio experience. Front height speakers may be used in conjunction with overhead speakers in larger room installations that can support a greater number of overhead/height outputs.

Combination: Overhead and Dolby Atmos Enabled Speakers

In some instances, a home theater system may already have overhead speakers that can be used to generate overhead audio. In this case, Dolby Atmos enabled speakers may be used to complement existing overhead speakers to create a full, four-speaker height experience. If existing overhead speakers are in the front of the room, then Dolby Atmos enabled speakers may be used in the rear of the room and vice versa.

Use of Existing Overhead Speakers

In some existing home theater systems, overhead speakers are employed to generate audio that would otherwise be created by listener-level speakers (for example, left/right surround speakers). When transitioning to Dolby Atmos, existing overhead speakers should only be repurposed as overhead outputs if a corresponding listener-level speaker can be added to assume the previous overhead speaker feed.

For example, if two overhead speakers located toward the rear of the room are currently used to reproduce left/right surround outputs, they should be used as overhead speakers only if replacement left/right surrounds can be added at the listener level. If this is not possible, the overhead speakers should continue to be used for left/right surround outputs. In this case, overhead sound can be achieved by installing additional overhead speakers, Dolby Atmos enabled speakers, or modules in the front speaker locations.

3. Standard Speaker Configurations

Dolby Conventions for Speaker Configurations

With the debut of Dolby Atmos, there is a new method of referring to surround sound speaker configurations (see the “Dolby Atmos for the Home Theater” white paper for more details). It is based on the standard nomenclature (stereo, 5.1, and 7.1) but adds a number at the end to specify the number of height speakers you employ in the playback system (for example, 7.1.4).

While manufacturers may decide to support more than one subwoofer output, Dolby Atmos technology generates a single low frequency effects (LFE) signal. Figures 5, 6, and 7 show the most common speaker layouts in a Dolby Atmos system for home theater.



Figure 5: A traditional 7.1 speaker layout with four Dolby Atmos enabled speakers (7.1.4).



Figure 6: A traditional 5.1 speaker layout with four overhead speakers (5.1.4).



Figure 7: A traditional 5.1 speaker layout with two Dolby Atmos enabled speakers (5.1.2).

Standard Setups for Both Overhead Speakers and Dolby Atmos Enabled Speakers

Images of standard setups follow for the most common speaker configurations and are provided for both overhead speakers and Dolby Atmos enabled speakers: 5.1.2 (Fig. 8, Fig. 9), 5.1.4 (Fig. 10, Fig. 11), 7.1.2 (Fig. 12, Fig. 13), 7.1.4 (Fig. 14, Fig. 15), and 9.1.2 (Fig. 16, Fig.17).



Home Theater Speaker Guide

Optimize your sound system that includes Dolby Atmos® technology with this step-by-step guide to the best speaker setup.

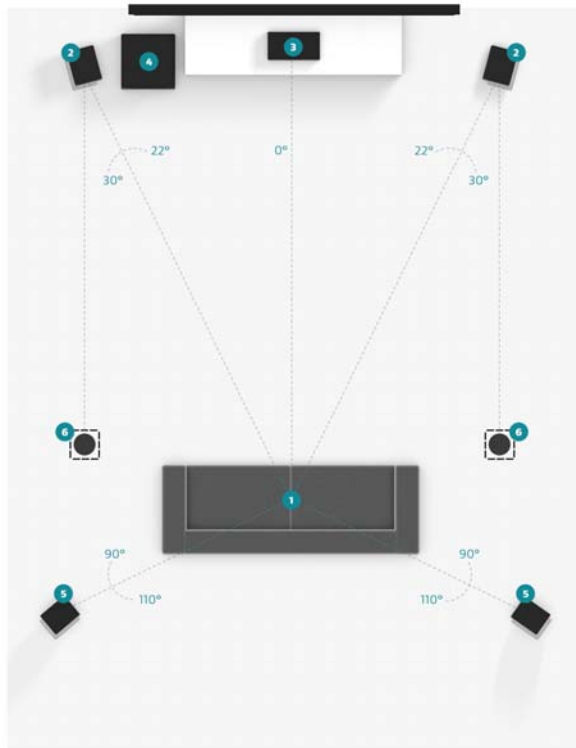

5.1.2 Speaker Placement

5.1.2 Overhead Speakers

1. Seating Position
2. Left and Right Speakers
3. Center Speakers
4. Subwoofer
5. L, R Surround Speakers
6. L, R Overhead Speakers

Dolby Atmos speaker setups: What do these numbers mean?

When shopping for Dolby Atmos home theater components, you'll see a new way of describing speaker configurations.

5.1.2

This refers to the number of traditional surround speakers (front, center, surround, etc.)

This number refers to how many powered subwoofers you can connect to your receiver.

This refers to how many overhead or Dolby Atmos enabled speakers you can use in your Dolby Atmos capable setup.



5.1.2 Perspective Detail

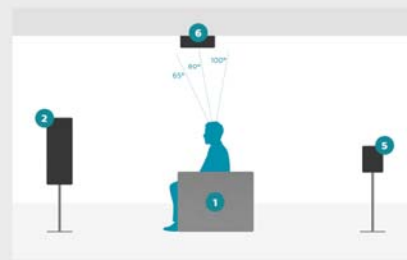

5.1.2 Ceiling Speaker Placement Detail

Figure 8: Standard 5.1.2 setup with overhead speakers.



Home Theater Speaker Guide

Optimize your sound system that includes Dolby Atmos® technology with this step-by-step guide to the best speaker setup.

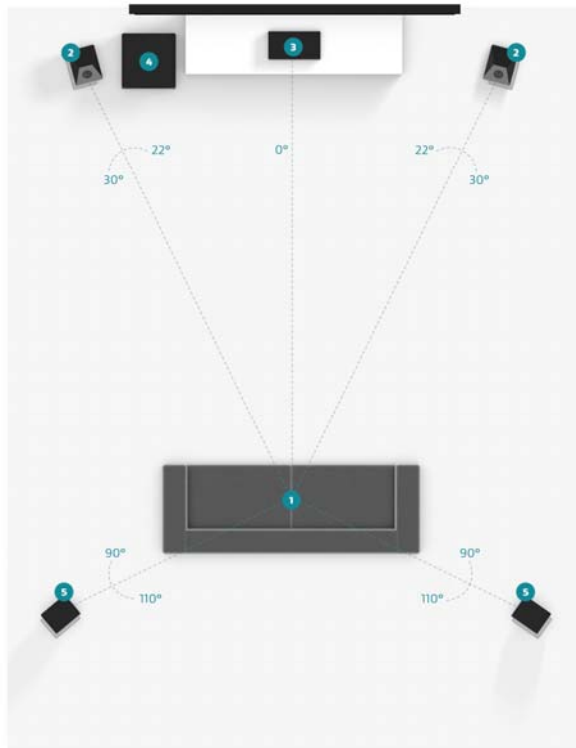

5.1.2 Speaker Placement

5.1.2 Dolby Atmos Enabled Speakers

1. Seating Position
2. Left and Right Dolby Atmos Enabled Speakers
3. Center Speakers
4. Subwoofer
5. L, R Surround Speakers

Dolby Atmos speaker setups: What do these numbers mean?

When shopping for Dolby Atmos home theater components, you'll see a new way of describing speaker configurations.

5.1.2

This refers to the number of traditional surround speakers (front, center, surround, etc.)

This number refers to how many powered subwoofers you can connect to your receiver.

This refers to how many overhead or Dolby Atmos enabled speakers you can use in your Dolby Atmos capable setup.



5.1.2 Perspective Detail

Figure 9: Standard 5.1.2 setup with Dolby Atmos enabled speakers.



Home Theater Speaker Guide

Optimize your sound system that includes Dolby Atmos® technology with this step-by-step guide to the best speaker setup.

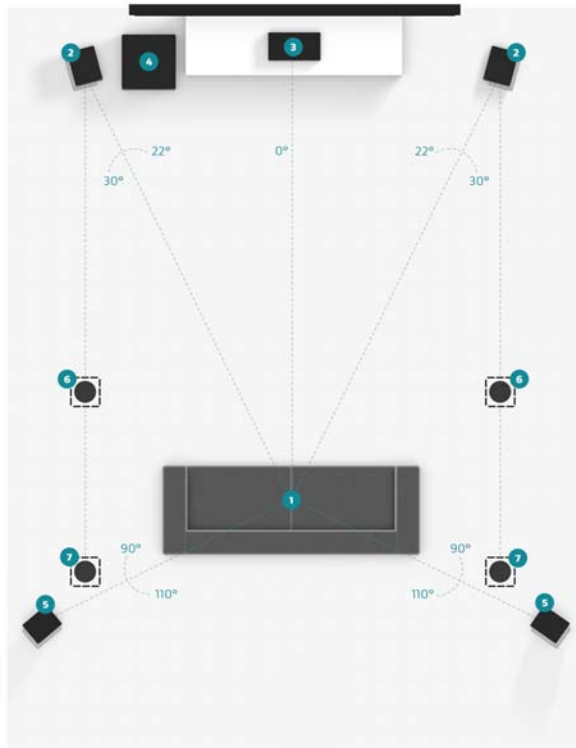

5.1.4 Speaker Placement

5.1.4 Overhead Speakers

1. Seating Position
2. Left and Right Speakers
3. Center Speakers
4. Subwoofer
5. L, R Surround Speakers
6. L, R Front Overhead Speakers
7. L, R Rear Overhead Speakers

Dolby Atmos speaker setups:

What do these numbers mean?

When shopping for Dolby Atmos home theater components, you'll see a new way of describing speaker configurations.

5.1.4

This refers to the number of traditional surround speakers (front, center, surround, etc.)

This number refers to how many powered subwoofers you can connect to your receiver.

This refers to how many overhead or Dolby Atmos enabled speakers you can use in your Dolby Atmos capable setup.



5.1.4 Perspective Detail

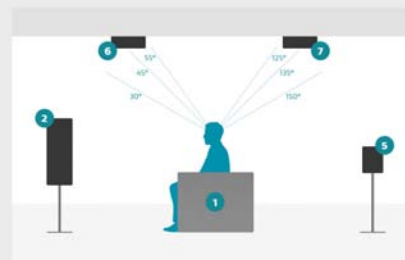

5.1.4 Ceiling Speaker Placement Detail

Figure 10: Standard 5.1.4 setup with overhead speakers.



Home Theater Speaker Guide

Optimize your sound system that includes Dolby Atmos® technology with this step-by-step guide to the best speaker setup.

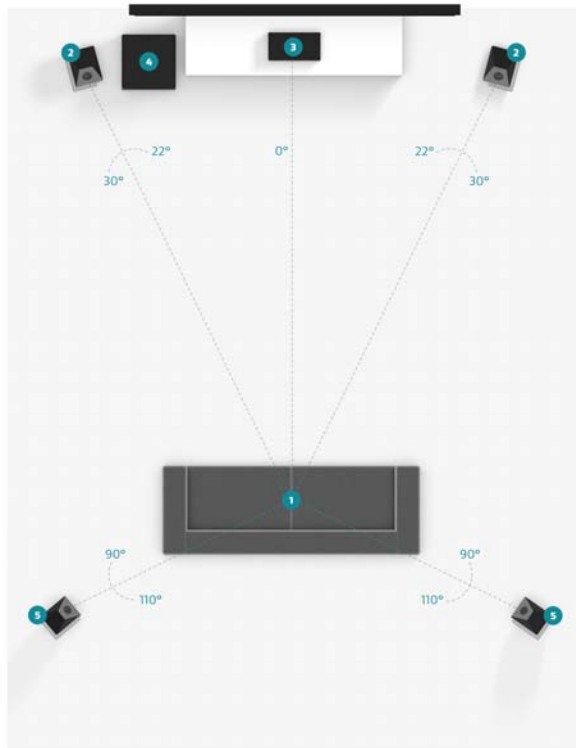

5.1.4 Speaker Placement

5.1.4 Dolby Atmos Enabled Speakers

1. Seating Position
2. Left and Right Dolby Atmos Enabled Speakers
3. Center Speakers
4. Subwoofer
5. L, R Dolby Atmos Enabled Surround Speakers

Dolby Atmos speaker setups: What do these numbers mean?

When shopping for Dolby Atmos home theater components, you'll see a new way of describing speaker configurations.

5.1.4

This refers to the number of traditional surround speakers (front, center, surround, etc.)

This number refers to how many powered subwoofers you can connect to your receiver.

This refers to how many overhead or Dolby Atmos enabled speakers you can use in your Dolby Atmos capable setup.



5.1.4 Perspective Detail

Figure 11: Standard 5.1.4 setup with Dolby Atmos enabled speakers.



Home Theater Speaker Guide

Optimize your sound system that includes Dolby Atmos® technology with this step-by-step guide to the best speaker setup.

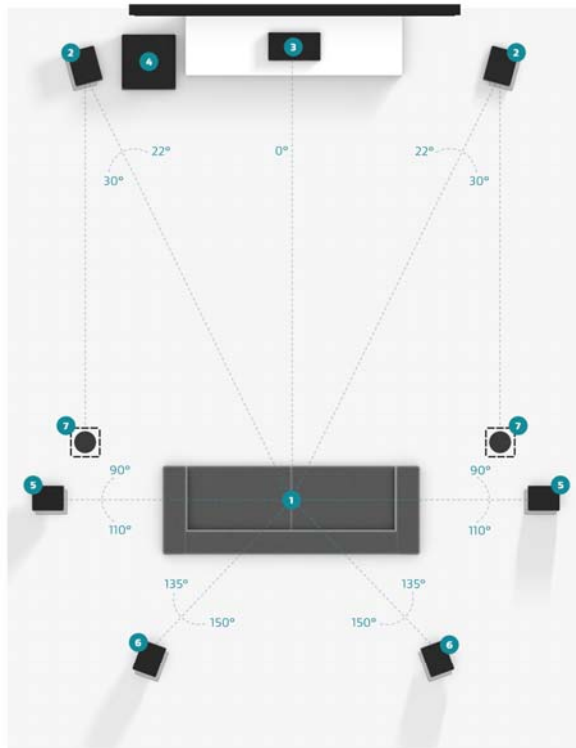

7.1.2 Speaker Placement

7.1.2 Overhead Speakers

1. Seating Position
2. Left and Right Speakers
3. Center Speakers
4. Subwoofer
5. L, R Surround Speakers
6. L, R Back Speakers
7. L, R Overhead Speakers

Dolby Atmos speaker setups: What do these numbers mean?

When shopping for Dolby Atmos home theater components, you'll see a new way of describing speaker configurations.

7.1.2

This refers to the number of traditional surround speakers (front, center, surround, etc.)

This number refers to how many powered subwoofers you can connect to your receiver.

This refers to how many overhead or Dolby Atmos enabled speakers you can use in your Dolby Atmos capable setup.



7.1.2 Perspective Detail

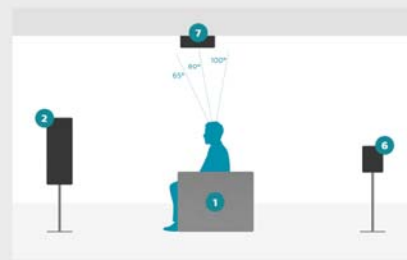

7.1.2 Ceiling Speaker Placement Detail

Figure 12: Standard 7.1.2 setup with overhead speakers.



Home Theater Speaker Guide

Optimize your sound system that includes Dolby Atmos® technology with this step-by-step guide to the best speaker setup.

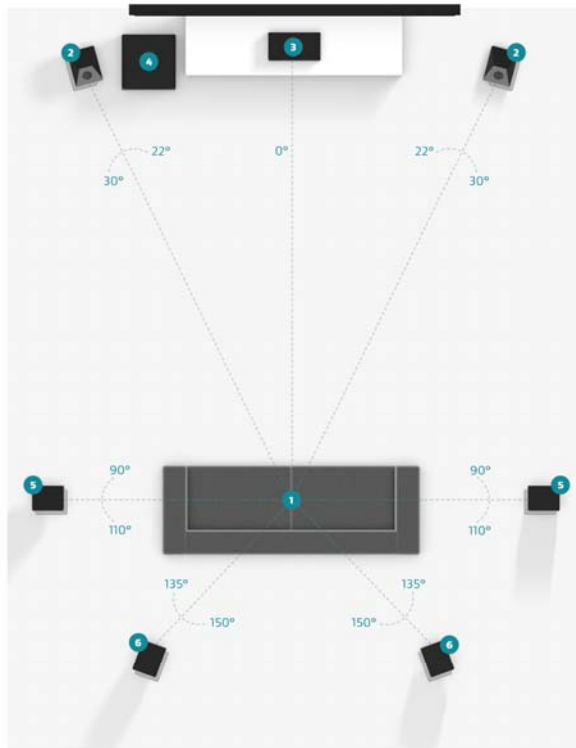

7.1.2 Speaker Placement

7.1.2 Dolby Atmos Enabled Speakers

1. Seating Position
2. Left and Right Dolby Atmos Enabled Speakers
3. Center Speakers
4. Subwoofer
5. L, R Surround Speakers
6. L, R Back Speakers

Dolby Atmos speaker setups: What do these numbers mean?

When shopping for Dolby Atmos home theater components, you'll see a new way of describing speaker configurations.

7.1.2

This refers to the number of traditional surround speakers (front, center, surround, etc.)

This number refers to how many powered subwoofers you can connect to your receiver.

This refers to how many overhead or Dolby Atmos enabled speakers you can use in your Dolby Atmos capable setup.



7.1.2 Perspective Detail

Figure 13: Standard 7.1.2 setup with Dolby Atmos enabled speakers.



Home Theater Speaker Guide

Optimize your sound system that includes Dolby Atmos® technology with this step-by-step guide to the best speaker setup.

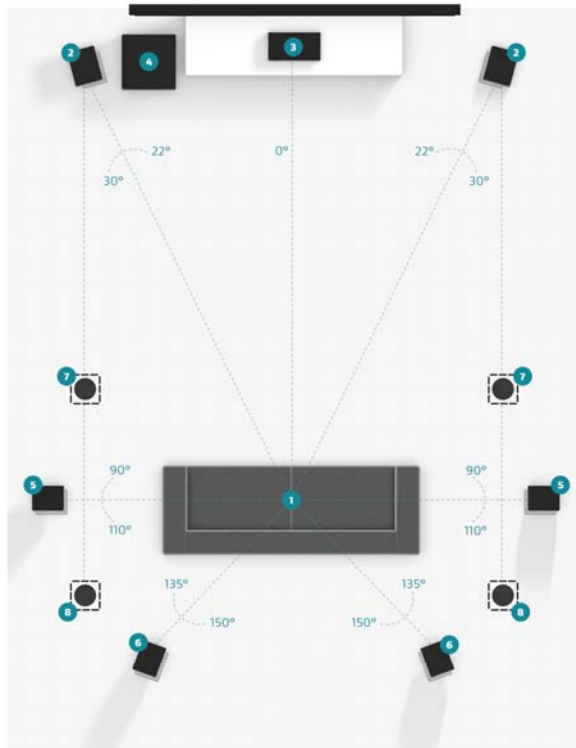

7.1.4 Speaker Placement

7.1.4 Overhead Speakers

1. Seating Position
2. Left and Right Speakers
3. Center Speakers
4. Subwoofer
5. L, R Surround Speakers
6. L, R Back Speakers
7. L, R Front Overhead Speakers
8. L, R Rear Overhead Speakers

Dolby Atmos speaker setups:

What do these numbers mean?

When shopping for Dolby Atmos home theater components, you'll see a new way of describing speaker configurations.

7.1.4

This refers to the number of traditional surround speakers (front, center, surround, etc.)

This number refers to how many powered subwoofers you can connect to your receiver.

This refers to how many overhead or Dolby Atmos enabled speakers you can use in your Dolby Atmos capable setup.



7.1.4 Perspective Detail

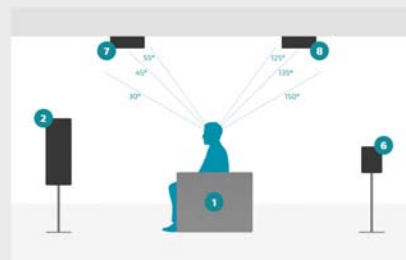

7.1.4 Ceiling Speaker Placement Detail

Figure 14: Standard 7.1.4 setup with overhead speakers.



Home Theater Speaker Guide

Optimize your sound system that includes Dolby Atmos® technology with this step-by-step guide to the best speaker setup.

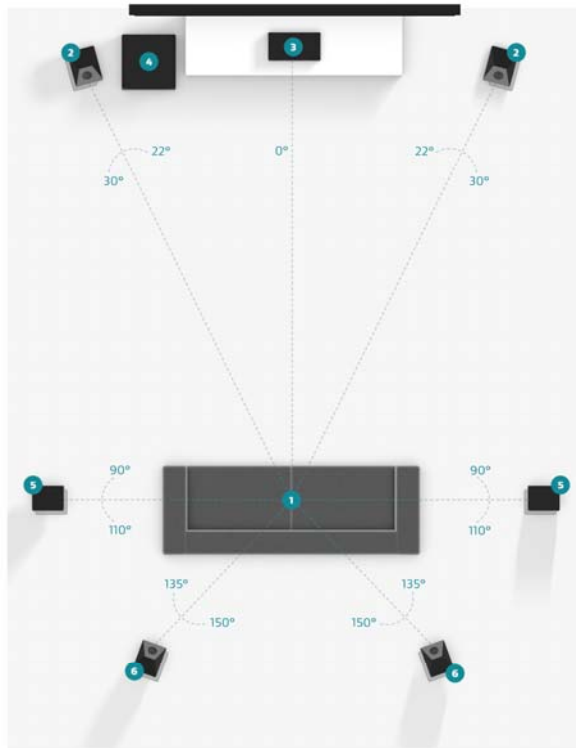

7.1.4 Speaker Placement

7.1.4 Dolby Atmos Enabled Speakers

1. Seating Position
2. Left and Right Dolby Atmos Enabled Speakers
3. Center Speakers
4. Subwoofer
5. L, R Surround Speakers
6. L, R Dolby Atmos Enabled Back Speakers

Dolby Atmos speaker setups: What do these numbers mean?

When shopping for Dolby Atmos home theater components, you'll see a new way of describing speaker configurations.

7.1.4

This refers to the number of traditional surround speakers (front, center, surround, etc.)

This number refers to how many powered subwoofers you can connect to your receiver.

This refers to how many overhead or Dolby Atmos enabled speakers you can use in your Dolby Atmos capable setup.



7.1.4 Perspective Detail

Figure 15: Standard 7.1.4 setup with Dolby Atmos enabled speakers.



Home Theater Speaker Guide

Optimize your sound system that includes Dolby Atmos® technology with this step-by-step guide to the best speaker setup.

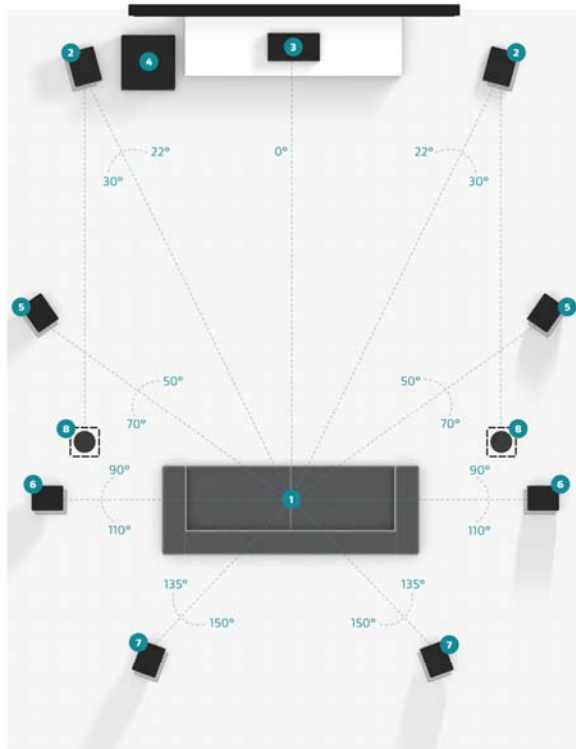

9.1.2 Speaker Placement

9.1.2 Overhead Speakers

1. Seating Position
2. Left and Right Speakers
3. Center Speakers
4. Subwoofer
5. L, R Wide Speakers
6. L, R Surround Speakers
7. L, R Back Speakers
8. L, R Overhead Speakers

Dolby Atmos speaker setups:

What do these numbers mean?

When shopping for Dolby Atmos home theater components, you'll see a new way of describing speaker configurations.

9.1.2

This refers to the number of traditional surround speakers (front, center, surround, etc.)

This number refers to how many powered subwoofers you can connect to your receiver.

This refers to how many overhead or Dolby Atmos enabled speakers you can use in your Dolby Atmos capable setup.



9.1.2 Perspective Detail

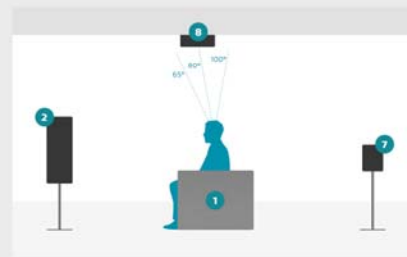

9.1.2 Ceiling Speaker Placement Detail

Figure 16: Standard 9.1.2 setup with overhead speakers.



Home Theater Speaker Guide

Optimize your sound system that includes Dolby Atmos® technology with this step-by-step guide to the best speaker setup.

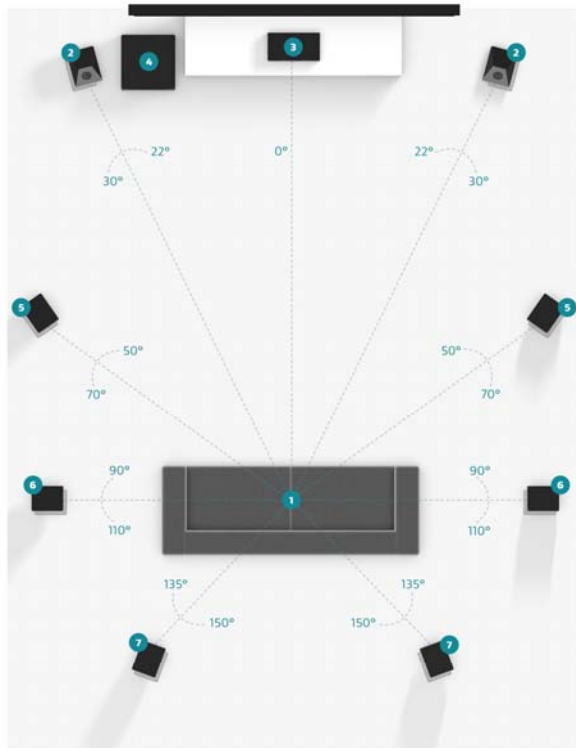

9.1.2 Speaker Placement

9.1.2 Dolby Atmos Enabled Speakers

1. Seating Position
2. Left and Right Dolby Atmos Enabled Speakers
3. Center Speakers
4. Subwoofer
5. L, R Wide Speakers
6. L, R Surround Speakers
7. L, R Back Speakers

Dolby Atmos speaker setups: What do these numbers mean?

When shopping for Dolby Atmos home theater components, you'll see a new way of describing speaker configurations.

9.1.2

This refers to the number of traditional surround speakers (front, center, surround, etc.)

This number refers to how many powered subwoofers you can connect to your receiver.

This refers to how many overhead or Dolby Atmos enabled speakers you can use in your Dolby Atmos capable setup.



9.1.2 Perspective Detail

Figure 17: Standard 9.1.2 setup with Dolby Atmos enabled speakers.

4. Additional Speaker Placement Guidelines

In addition to the typical configurations in the previous section, Dolby Atmos can support a variety of additional speaker positions, up to a maximum of 34 total (for example, 24.1.10).

This section focuses on the placement of speakers, which may be added to the positions covered in section 3. For clarity, the positions covered in section 3 were:

- Left/Right speaker pair
- Left Surround/Right Surround speaker pair
- Left Rear Surround/Right Rear Surround speaker pair
- Left Wide/Right Wide speaker pair
- Left Front Overhead/Right Front Overhead speaker pair
- Left Middle Overhead/Right Middle Overhead speaker pair
- Left Rear Overhead/Right Rear Overhead speaker pair

For information on how to position these standard speaker positions, please refer back to section 3.

Listener-Level Speaker Placement Guidelines

This section provides placement guidelines for the following nontraditional listener speakers:

- Left Center/Right Center speaker pair
- Left Screen/Right Screen speaker pair
- Left Surround 1/Right Surround 1 speaker pair
- Left Surround 2/Right Surround 2 speaker pair
- Left Rear Surround 1/Right Rear Surround 1 speaker pair
- Left Rear Surround 2/Right Rear Surround 2 speaker pair
- Left Center Surround/Right Center Surround speaker pair
- Center Surround speaker

In the following descriptions and examples, the term *center-front reference* denotes an imaginary line between the listener position and the middle of the screen or the placement of the Center speaker.

Note that, in all of these examples, speakers are added in pairs. This is crucial to ensure an optimal Dolby Atmos playback environment.

Left Center/Right Center speaker pair

The Left Center and Right Center speakers should ideally be placed at approximately 15 degrees between the Left and Right speakers and the center-front reference. If the Left Screen and Right Screen speakers are included in the speaker layout, we recommend distances between the Left and Right, Left Center and Right Center, Left Screen and Right Screen, and Center speakers be subdivided and that the Left Center and Right Center speakers be placed at approximately 30 degrees from the center-front reference.

Figure 18 shows the range of angles at which the Left Center and Right Center speakers may be placed.

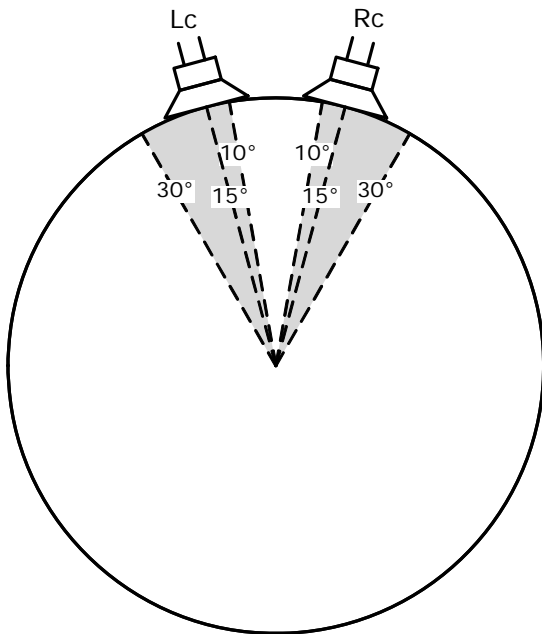

Figure 18: Left Center and Right Center speaker placement.

Left Screen/Right Screen speaker pair

The Left Screen and Right Screen speakers should be placed between the Left Center and Right Center speakers and the center-front reference. We recommend that the distances between the Left and Right, Left Center and Right Center, Left Screen and Right Screen, and Center speakers be subdivided and the Left Screen and Right Screen speakers be placed at approximately 15 degrees from the center-front reference.

Figure 19 shows the range of angles at which the Left Screen and Right Screen speakers may be placed.

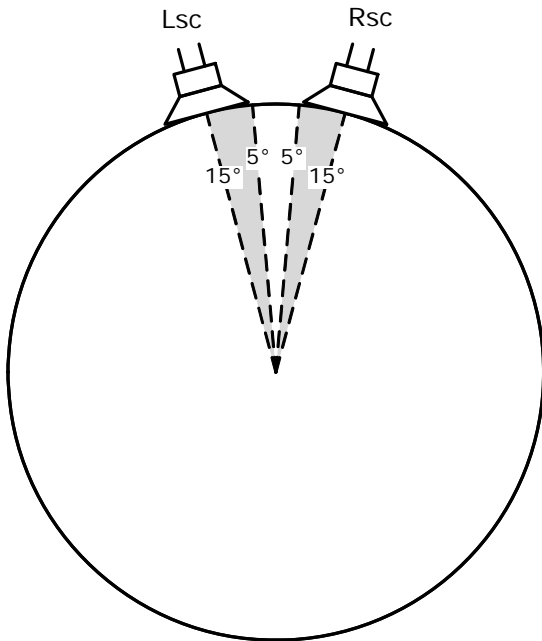

Figure 19: Left Screen and Right Screen speaker placement.

Left Surround 1/Right Surround 1 speaker pair

The Left Surround 1 and Right Surround 1 speakers should be placed between the Left Surround and Right Surround and Left Wide and Right Wide speakers at approximately 75 degrees from the center-front reference. Figure 20 shows the range of angles at which the Left Surround 1 and Right Surround 1 speakers may be placed.

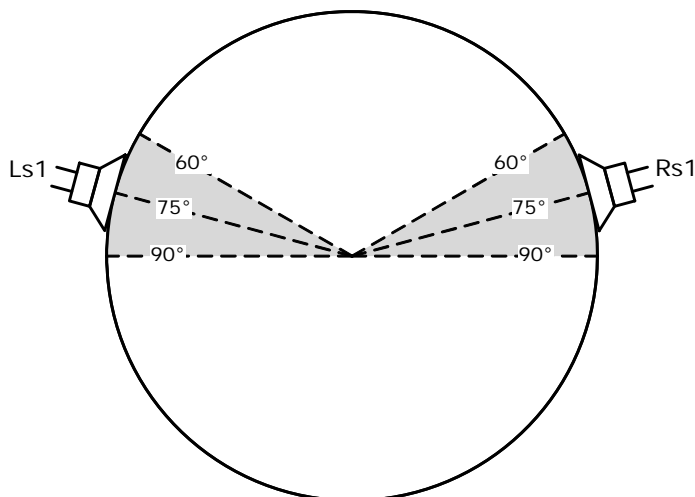

Figure 20: Left Surround 1 and Right Surround 1 speaker placement.

Left Surround 2/Right Surround 2 speaker pair

The Left Surround 2 and Right Surround 2 speakers should be placed between the Left Surround and Right Surround and Left Rear Surround 1 and Right Rear Surround 1 speakers at approximately 105 degrees from the center-front reference.

Figure 21 shows the range of angles at which the Left Surround 2 and Right Surround 2 speakers may be placed.

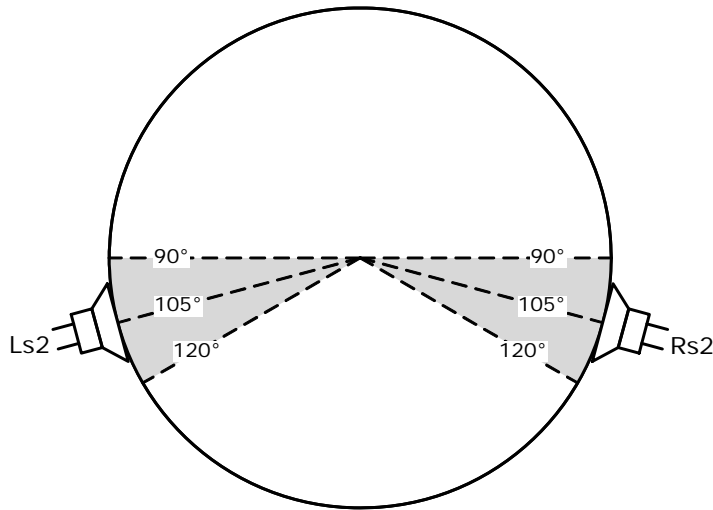

Figure 21: Left Surround 2 and Right Surround 2 speaker placement.

Left Rear Surround 1/Right Rear Surround 1 speaker pair

The Left Rear Surround 1 and Right Rear Surround 1 speakers should be placed between the Left Surround and Right Surround and Left Rear Surround and Right Rear Surround speakers at approximately 120 degrees from the center-front reference. If the Left Surround 2 and Right Surround 2 speakers are also included in the speaker layout, we recommend that the distances between Left Surround and Right Surround, Left Surround 2 and Right Surround 2, Left Rear Surround 1 and Right Rear Surround 1, and Left Rear Surround and Right Rear Surround speakers be subdivided so that the Left Rear Surround 1 and Right Rear Surround 1 speakers are closer to the Left Rear Surround and Right Rear Surround speakers at approximately 135 degrees from the center-front reference.

Figure 22 shows the range of angles at which the Left Rear Surround 1 and Right Rear Surround 1 speakers may be placed.

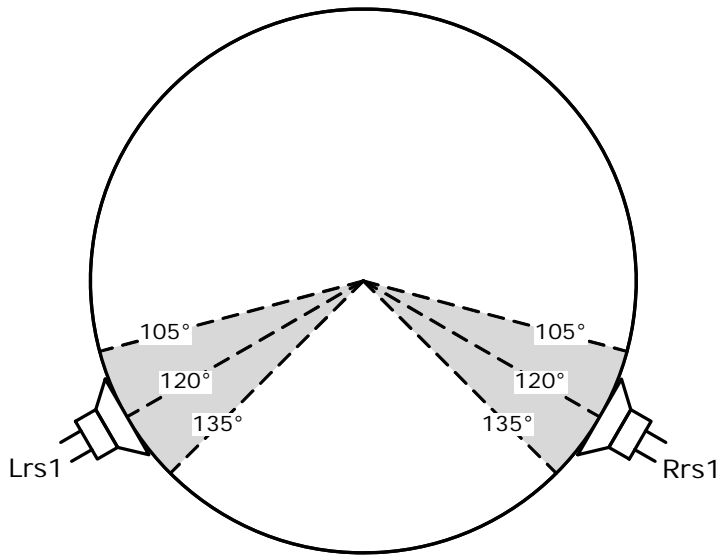

Figure 22: Left Rear Surround 1 and Right Rear Surround 1 speaker placement.

Left Rear Surround 2/Right Rear Surround 2 speaker pair

The Left Rear Surround 2 and Right Rear Surround 2 speakers should be placed between the Left Rear Surround and Right Rear Surround and Left Center Surround and Right Center Surround speakers at approximately 145 degrees from the center-front reference.

Figure 23 shows the range of angles at which the Left Rear Surround 2 and Right Rear Surround 2 speakers may be placed.

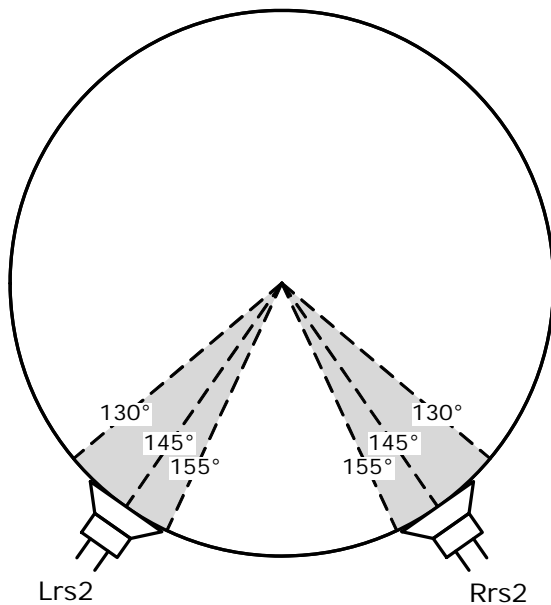

Figure 23: Left Rear Surround 2 and Right Rear Surround 2 speaker placement.

Left Center Surround/Right Center Surround speaker pair

The Left Center Surround and Right Center Surround speakers should be placed between the Left Rear Surround, Right Rear Surround, and Center Surround speakers at approximately 165 degrees from the center-front reference.

Figure 24 shows the range of angles at which the Left Center Surround and Right Center Surround speakers may be placed.

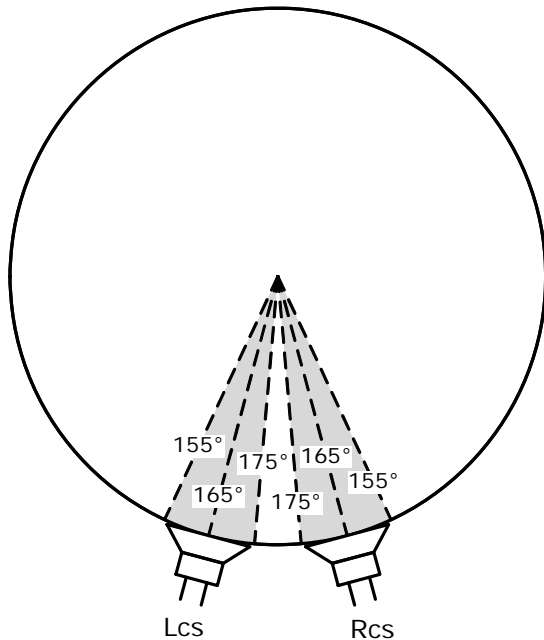

Figure 24: Left Center Surround and Right Center Surround speaker placement.

Center Surround speaker

The Center Surround speaker should be placed at 180 degrees from the center front axis directly behind the listener.

Overhead/Height Speaker Placement Guidelines

This section provides placement guidelines for the following height speakers:

- Left Front Height/Right Front Height speaker pair
- Left Rear Height/Right Rear Height speaker pair

In the following descriptions and examples, the term *center-front reference* denotes an imaginary line between the listener position and the middle of the screen or the placement of the Center speaker.

Note that, in all of these examples, overhead speakers must be added to the playback system in pairs.

Left Front Height/Right Front Height speaker pair

The Left Front Height and Right Front Height speakers should be mounted on the front wall (instead of on the ceiling) in line with an approximately 30 degrees horizontal from the center-front reference. This places the Left Front Height and Right Front Height speakers directly above the Left and Right speakers. If the Left Front Height and Right Front Height speakers must be mounted on the ceiling, they should be placed no more than one-eighth the distance to the middle of the room, approximately 45 degrees vertical from the center-front reference. This guidance represents a slight change from the original Dolby Pro Logic IIz documentation, which mandated Z series speakers not be placed inside the left and right main speakers (for example, closer to the Center speaker).

The Left Front Height and Right Front Height speakers are typically included in Dolby Pro Logic IIz products.

Figures 25 and 26 show the range of angles at which the Left Front Height and Right Front Height speakers may be placed.

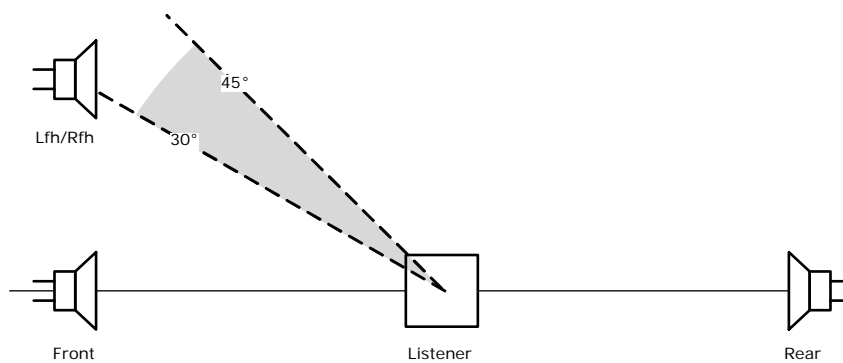

Figure 25: Side view of Left Front Height and Right Front Height speaker placement.

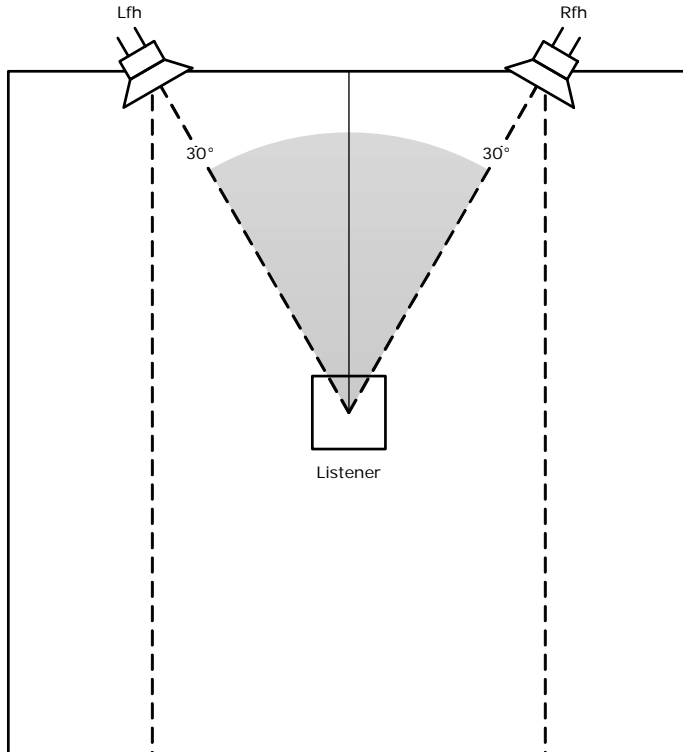

Figure 26: Top view of Left Front Height and Right Front Height speaker placement.

Left Rear Height/Right Rear Height speaker pair

We recommend that the Left Rear Height and Right Rear Height speakers should be mounted on the rear wall (instead of on the ceiling) in line with an approximately 30 degrees horizontal from the center-front reference. If the Left Rear Height and Right Rear Height speakers must be mounted overhead, they should be placed no more than one-eighth the distance to the middle of the room, approximately 135 degrees vertical from the center-front reference. Figures 27 and 28 show the range of angles at which the Left Rear Height and Right Rear Height speakers may be placed.

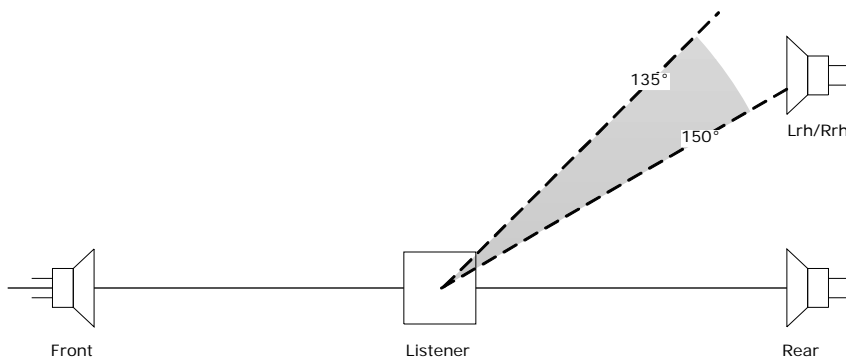

Figure 27: Side view of Left Rear Height and Right Rear Height speaker placement.

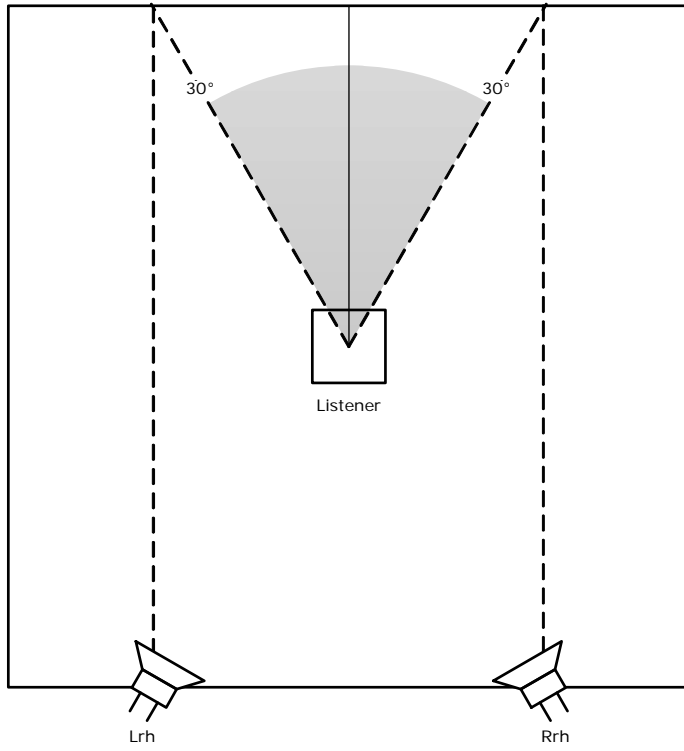

Figure 28: Top view of Left Rear Height and Right Rear Height speaker placement.

5. Dolby Surround Upmixer

Clients that invest in a Dolby Atmos home theater naturally expect to get full use of all of their components, even when the content they are playing isn't mixed in Dolby Atmos. This includes taking advantage of overhead and Dolby Atmos enabled speakers to further enhance the playback experience.

Included in the Dolby Atmos technology bundle is a new, advanced upmixer designed to be compatible with traditional channel-based as well as Dolby Atmos speaker systems. The Dolby surround upmixer expands the audio of legacy channel-based content, including native stereo, 5.1, and 7.1 content, for playback through a Dolby Atmos system—regardless of speaker number or placement—while simultaneously honoring and maintaining the artists' intent for the mix.

The Dolby surround upmixer analyzes and processes multiple perceptually spaced frequency bands, accurately steering each individually. The result is a surround playback experience characterized by precisely located audio elements and a more spacious ambience.

In a Dolby Atmos system, the channel-based mix is fully honored. Dolby Atmos enabled speakers and overhead speakers are employed to lend a sense of atmospheric or room effect to the listening experience. This new technology will process and upmix channel-based content to as many as 17 speaker locations at listener level and 10 Dolby Atmos enabled or overhead speakers. Note: To maintain an accurate frontal audio image, the upmixer will not send upmixed audio to the front wide speakers or any speakers that are located between the Left, Center, and Right speakers. Audio is not upmixed to the Center Surround speaker.

A Center spread on/off control enables the user to spread the center image across a wider front soundstage. This optional feature is ideally suited for playback of two-channel music content or playback of channel-based content in a home theater design that employs a wider screen configuration than typical installations.

The Dolby surround and center spread function should be selected from the AVR or pre-processor user interface or from the system's remote control.

Dolby, Dolby Atmos, Pro Logic, and the double-D symbol are registered trademarks of Dolby Laboratories. Academy Award is a trademark and service mark of the Academy of Motion Picture Arts and Sciences. HDMI is a trademark or registered trademark of HDMI Licensing, LLC in the United States and other countries. © 2014 Dolby Laboratories, Inc. All rights reserved. S14/28264