

**PDP-427CMX INDUSTRIAL PLASMA DISPLAY PANEL
SERIAL COMMAND REFERENCE MANUAL (version 1.0)**

This manual provides information for controlling the PDP-427CMX industrial plasma display panel with an external communication device by using serial commands.

Released: January 23, 2007

TABLE OF CONTENTS

1	About the RS-232C Adjustment.....	2
2	Interface	3
3	Combination Connection	4
4	ID Assignment.....	5
5	List of Commands.....	7
6	QUEST Commands	15

RS-232C Adjustment

RS-232C Adjustment

This display has an RS-232C terminal. It is possible to use a PC to make various adjustments and settings.

1 About the RS-232C Adjustment

Adjustments using the RS-232C:

- The adjustments are written to the same memory area as for the integrator mode (refer to section 5.4.4, "PICTURE, White Balance and SCREEN Position Adjustment Values Memory Area Tables" (pg. 257 to 261)).

Note

- (1) **Assign an ID before using the RS-232C adjustment. Include the panel ID in the RS-232C command. For details, refer to section 5.5.2, "Interface" (pg. 263).**
- (2) Of the adjustment values and setting items set by RS-232C commands, there are some items that are stored in memory and some that are not. For details, refer to section 5.5.5, "List of RS-232C Commands" (pg. 267). Also, when storing values in "last" memory, the conditions described in section 5.1.5, "Last Memory" (pg. 170), must be satisfied.
- (3) <OSDS00>/<OSDS01> (OSD display disable/enable setting)
Regardless of the setting, the following items can be displayed.
 - Menu display (menu mode, integrator mode)
 - Warnings before Auto Power OFF or Power Management operation
 - Warning of high temperature inside the panel
 - Display announcing that the FUNCTIONAL LOCK is set and the FUNCTIONAL LOCK setting display
 - Display call (including holding a button down)
- (4) When using RS-232C commands, control the input signal as well as the power. If the power is ON when there is no signal, the display continues to have a weak discharge. This activity can affect the life of the display.

2 Interface

- 1) Connector
D-sub 9 pins (male/straight)
- 2) Pin layout

Pin No.	Signal	Pin No.	Signal
1	NC (not connected)	6	NC (not connected)
2	TxD (Transmit Data)	7	NC (not connected)
3	RxD (Receive Data)	8	RTS (Request To Send)
4	NC (not connected)	9	NC (not connected)
5	GND		

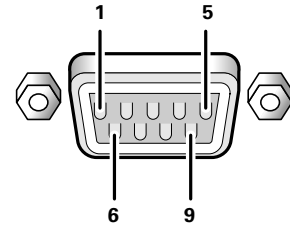

- 3) Baud Rate
9 600 bps (standard)
(switch-able to 1 200, 2 400, 4 800, 19 200, 38 400 bps)

Note

The baud rate of this display should be set to match the baud rate of the PC.
Also, when the RS-232C cable is extended over a long distance, use a slower baud rate.

- 4) Data format
Start bit: 1 bit
Data bit: 8 bit
Parity: no
Stop bit: 1 bit

- 5) Connection

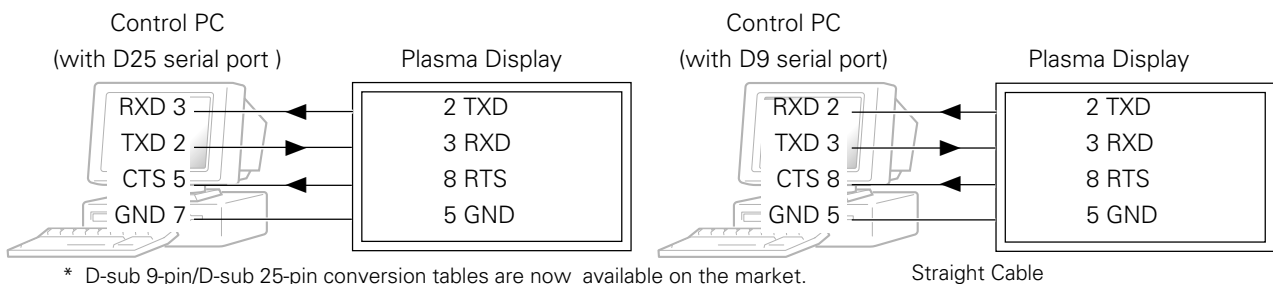

* D-sub 9-pin/D-sub 25-pin conversion tables are now available on the market.

- 6) Protocol

From the PC to the display

- (1) Sending one command at a time:

STX (02 hex)	ID (2 Byte)	COMMAND (3 Byte or 6 Byte)	ETX (03 hex)
--------------	-------------	----------------------------	--------------

- (2) Sending numerical direct commands:

STX (02 hex)	ID (2 Byte)	COMMAND (3 Byte)	ARGUMENT (3 Byte)	ETX (03 hex)
--------------	-------------	------------------	-------------------	--------------

ID, COMMAND, ARGUMENT are transmitted as ASCII characters.

From the display to a PC

- (1) Echo back (Normal response)

Command received and returned but the ID is not returned.

STX (02 hex)	COMMAND (3 Byte or 6 Byte)	ETX (03 hex)
--------------	----------------------------	--------------

Received command is a numerical direct effect command and numerical data is returned:

STX (02 hex)	COMMAND (3 Byte)	ARGUMENT (3 Byte)	ETX (03 hex)
--------------	------------------	-------------------	--------------

- (2) Error (Abnormal response)

Received command is a non-corresponding command, 'ERR' is returned:

STX (02 hex)	ERR (3 Byte)	ETX (03 hex)
--------------	--------------	--------------

Received command cannot be processed (when PON is received when the power is already ON, etc.), 'XXX' is returned:

STX (02 hex)	XXX (3 Byte)	ETX (03 hex)
--------------	--------------	--------------

RS-232C Adjustment

3 Combination Connection

When controlling/adjusting panels, it is convenient to connect several displays to one PC.

By performing a combination connection and assigning IDs to the panels, it is possible to control and adjust several displays at the same time or separately.

Connection method:

Connect the panels as shown in the figure below.

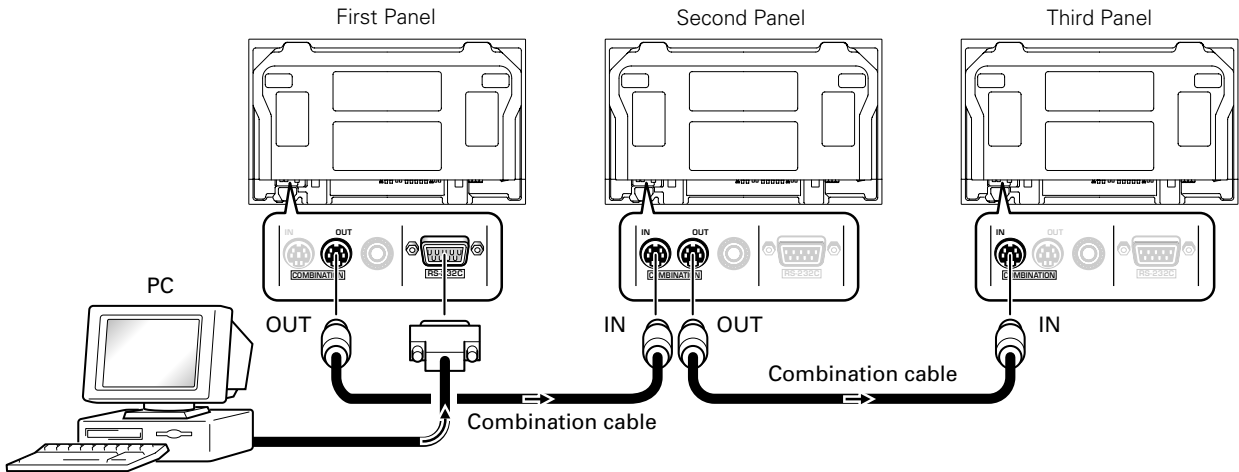

Note

Only the combination IN terminal or the RS-232C terminal can be used at the same time. Connecting them at the same time could cause errors. Also, do not pair combination IN terminals or combination OUT terminals. Doing so could cause communication to fail.

It is possible to use a general-purpose mini DIN 6-pin (straight) cable for the combination cable.

Note

To output RS-232C signals from the combination OUT terminal, an ID must be assigned. For details, refer to section, 5.5.4, "ID Assignment" (pg. 265).

4 ID Assignment

The ID is assigned from the PC.

- Commands: <IDC> (ID CLEAR) Clears the assigned ID
- <IDS> (ID SET) Assigns an ID
- IDS is only effective when an ID is not assigned.
- IDs are assigned starting from the panel closest to the PC.

Example: Case of 4 displays (assigning IDs with the PC for the first time)

First, connect an RS-232C and combination cables. (Refer to section 5.5.3, "Combination Connection" (pg. 264).)

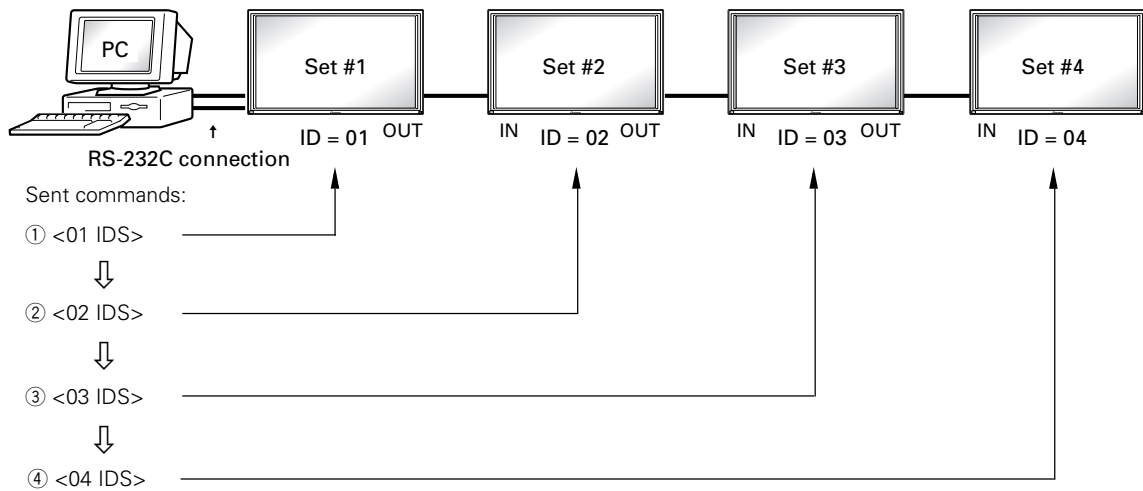

By sending RS-232C commands in this order, it is possible to assign an ID for each panel. When a panel has a PC-assigned ID, it can only receive commands containing the ID. Assign an ID before sending a command.

Characters that can be used for an ID include, 0 - 9 and A - F (there is not distinction between upper case and lower case letters).

An * (asterisk) can be used as follows:

- <**IDC>: Clear the IDs assigned for all panels
- <2*IN1>: The input for which the first digit is 2 is set to INPUT1

Precautions when assigning IDs

Panels connected after a display's ID has been cleared cannot be operated with RS-232C commands. When the <**IDC> command is sent, the IDs for all the sets from Set #1 to Set #4 are cleared. Only the first panel, which is directly connected to the PC, can be controlled. Send the command <01 IDS> to control the next panel. Continue setting IDs in this way for the remaining panels to once again control the displays.

Note

When the IDs are set, when one or both of the IDs before a command is sent from the PC is an *, there is no echo. When sending more commands, wait six seconds before sending the next command.

Example) When **000 and *1000 or 1*000 (000 is the command) are sent from the PC, operation is performed but there is no echo.

RS-232C Adjustment

Under the connection conditions shown below, use a combination cable for up to 16 panels.

- Conditions:
- ① Length of RS-232C cable connecting PC to Plasma Display: 5 m
 - ② Combination cable length: 5 m each
 - ③ Wire specifications for linking cable: Mini Din 6-pin straight (7 strand cable)

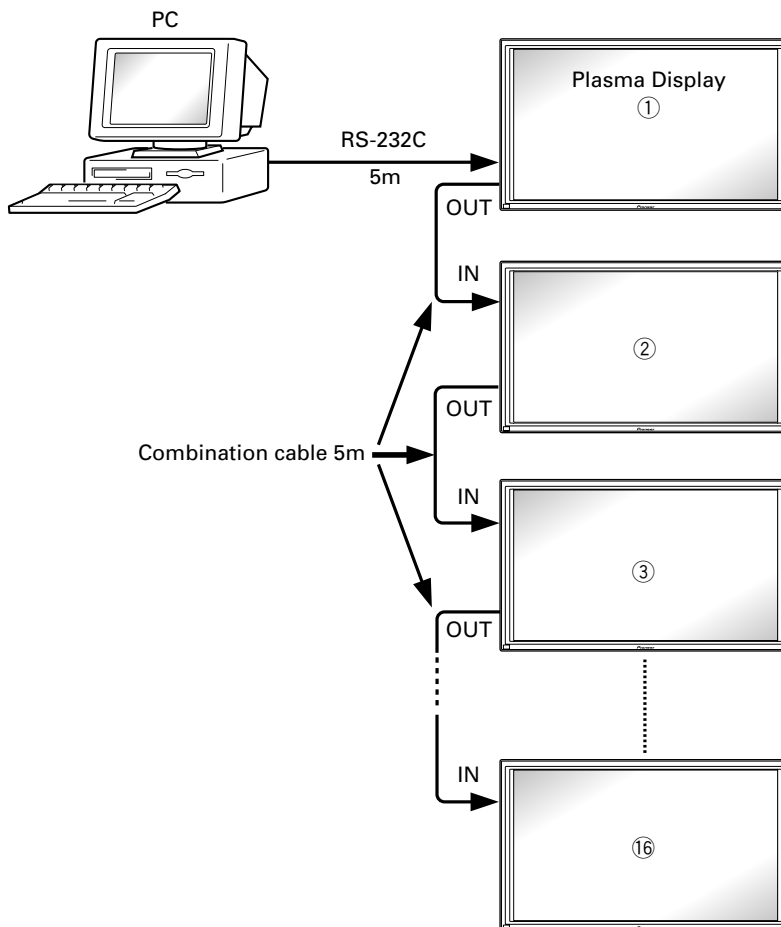
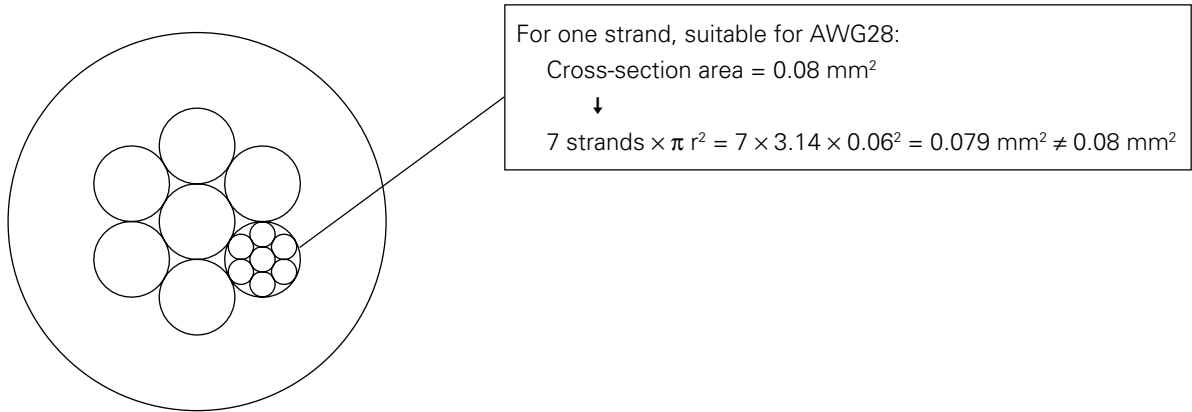

Note

For details on the number of displays that can be connected in series using the video OUT terminal (INPUT1, 4), refer to section 2.3, "Controls and Connectors" (pg. 12).

5 List of RS-232C Commands (Command 434CMX = Command 43MXE1 / Command 505CMX = Command 50MXE10 , 50MXE11 , 50MXE1 , 50MXE1-S / Command 425CMX = Command 42MXE10)

■ Normal Operation Related Commands

Command 434CMX 505CMX	Command 425CMX	Command 427CMX 507CMX	Function	Number direct			Last memory	Comment
				Effective	Minimum	Maximum		
POWER								
POF	←	←	Turns the power OFF.				●	
PON	←	←	Turns the power ON.				●	
INPUT SELECT								
INP	←	←	Displays the present input.					
INPS01	←	←	Switches the main screen to INPUT1.				●	
INPS02	←	←	Switches the main screen to INPUT2.				●	
INPS03	←	←	Switches the main screen to INPUT3.				●	
INPS04	←	←	Switches the main screen to INPUT4.				●	
INPS05	←	←	Switches the main screen to INPUT5.				●	
IN1	←	←	Switches the main screen to INPUT1.				●	
IN2	←	←	Switches the main screen to INPUT2.				●	
IN3	←	←	Switches the main screen to INPUT3.				●	
IN4	←	←	Switches the main screen to INPUT4.				●	
IN5	←	←	Switches the main screen to INPUT5.				●	
SSIS01	←	←	Switches the sub screen to INPUT1.				●	
SSIS02	←	←	Switches the sub screen to INPUT2.				●	
SSIS03	←	←	Switches the sub screen to INPUT3.				●	
SSIS04	←	←	Switches the sub screen to INPUT4.				●	
SSIS05	←	←	Switches the sub screen to INPUT5.				●	
-	SWM	←	Outputs main input to the full screen.				●	
-	SWS	←	Outputs sub input to the full screen.				●	
SCREEN SIZE								
AST	←	←	Executes auto-setup.				●	
SZM	←	←	Displays the present screen size.					
SZMS00	←	←	Sets SCREEN SIZE to DOT BY DOT.				●	
SZMS01	←	←	Sets SCREEN SIZE to 4 :3.				●	
SZMS02	←	←	Sets SCREEN SIZE to FULL.				●	
SZMS03	←	←	Sets SCREEN SIZE to ZOOM.				●	
SZMS05	←	←	Sets SCREEN SIZE to WIDE.				●	
-	SZMS06	←	Sets SCREEN SIZE to 14:9.				●	
SZMS09	←	←	Sets SCREEN SIZE to UNDERSCAN.				●	
-	SZMS10	←	Sets SCREEN SIZE to 2.35:1.				●	
VIDEO								
MTN	PMTS00	←	Turns video mute to OFF.				●	
MTY	PMTS01	←	Turns video mute to ON.				●	
SLN	STLS00	←	Cancels FREEZE.				●	
SLY	STLS01	←	Sets FREEZE.				●	
AUDIO								
VOL	←	←	Adjusts audio volume.	●	000	042	●	
AMN	AMTS00	←	Turns audio mute to OFF.				●	
AMY	AMTS01	←	Turns audio mute to ON.				●	
-	AUSS01	←	Sets the audio source to main.				●	
-	AUSS02	←	Sets the audio source to sub.				●	
MULTI SCREEN								
MSC	←	←	Displays the present multi-screen.					
-	MSCS00	←	Turns MULTI SCREEN to OFF.				●	
-	MSSS01	←	Sets the PinP subscreen size to 1.				●	
-	MSSS02	←	Sets the PinP subscreen size to 2.				●	
-	MSSS03	←	Sets the PinP subscreen size to 3.				●	
-	MSSS04	←	Sets the PinP subscreen size to 4.				●	
MST	←	←	Displays the present multi-screen type.					
MSTS01	←	←	Sets the MULTI SCREEN to 2 SCREEN (side by side 1)				●	
MSTS02	←	←	Sets the MULTI SCREEN to PinP (lower right).				●	
MSTS03	←	←	Sets the MULTI SCREEN to PinP (upper right).				●	
MSTS04	←	←	Sets the MULTI SCREEN to PinP (upper left).				●	
MSTS05	←	←	Sets the MULTI SCREEN to PinP (lower left).				●	

RS-232C Adjustment

Command 434CMX 505CMX	Command 425CMX	Command 427CMX 507CMX	Function	Number direct			Last memory	Comment
				Effective	Minimum	Maximum		
MSTS06	←	←	Sets the MULTI SCREEN to PoutP (side by side, 2-L).				●	
–	MSTS08	←	Sets MULTI SCREEN to SWAP (switches between main and sub screens).				●	
–	MSTS09	←	Sets MULTI SCREEN to PoutP (side by side 2-R).				●	
–	MSTS10	←	Sets MULTI SCREEN to 2-SCREEN (side by side 3).				●	
–	MSTS11	←	Sets MULTI SCREEN to PoutP (side by side 4-L).				●	
–	MSTS12	←	Sets MULTI SCREEN to PoutP (side by side 4-R).				●	
SSI	←	←	Displays the present input to the SUB Screen.					
FUNCTIONAL LOCK								
FCL	←	←	Displays the present set value of the FUNCTIONAL LOCK.					
FCLS00	←	←	Cancels FUNCTIONAL LOCK.				●	
FCLS01	←	←	Prohibits operation of buttons on the display.				●	
FCLS02	←	←	Prohibits operation of buttons on the remote control.				●	
FCLS03	←	←	Prohibits operation of buttons on the display/remote control.				●	
FCLS04	←	←	Sets the memory lock				●	
OSD								
DOF	←	←	Turns off the OSD display that is now displayed.					

■ “MENU” – “SETUP” related commands

Command 434CMX 505CMX	Command 425CMX	Command 427CMX 507CMX	Function	Number direct			Last memory	Comment
				Effective	Minimum	Maximum		
COLOR TEMP.								
CTP	←	←	Displays the present set value of the color temperature.					
CTPS01	←	←	Sets the color temperature to LOW.				●	
CTPS02	←	←	Sets the color temperature to MID LOW.				●	
CTPS03	←	←	Sets the color temperature to MIDDLE.				●	
CTPS04	←	←	Sets the color temperature to MID HIGH.				●	
CTPS05	←	←	Sets the color temperature to HIGH.				●	
DNR								
DNR	←	←	Displays the present set value of the DNR.					
DNRS00	←	←	Sets digital NR to OFF.				●	
DNRS01	←	←	Sets digital NR to LOW.				●	
DNRS02	←	←	Sets digital NR to MIDDLE.				●	
DNRS03	←	←	Sets digital NR to HIGH.				●	
MPEG NR								
MNR	←	←	Displays the present set value of the MPEG NR.					
MNRS00	←	←	Sets MPEG NR to OFF.				●	
MNRS01	←	←	Sets MPEG NR to LOW.				●	
MNRS02	←	←	Sets MPEG NR to MIDDLE.				●	
MNRS03	←	←	Sets MPEG NR to HIGH.				●	
CTI								
CTR	←	←	Displays the present set value of CTI.					
CTRS00	←	←	Sets CTI to OFF.				●	
CTRS01	←	←	Sets CTI to ON.				●	
PURE CINEMA								
PUC	←	←	Displays the present set value of PURE CINEMA.					
PUCS00	←	←	Sets PURE CINEMA to OFF.				●	
PUCS01	←	←	Sets PURE CINEMA to STANDARD.				●	
COLOR DECORDING								
MCD	←	←	Displays the present color decoding.					
MCDS01	←	←	Sets COLOR DECORDING to RGB (VIDEO).				●	
MCDS02	←	←	Sets COLOR DECORDING to COMPONENT1 (YCbCr).				●	
MCDS03	←	←	Sets COLOR DECORDING to COMPONENT2 (YPbPr).				●	
COLOR SYSTEM								
CLS	←	←	Displays the present set value of the color system.					
CLSS01	←	←	Sets color system to AUTO.				●	
CLSS02	←	←	Sets color system to NTSC.				●	
CLSS03	←	←	Sets color system to PAL.				●	
CLSS04	←	←	Sets color system to SECAM.				●	

Command 434CMX 505CMX	Command 425CMX	Command 427CMX 507CMX	Function	Number direct			Last memory	Comment
				Effective	Minimum	Maximum		
CLSS05	←	←	Sets color system to 4.43NTSC.				●	
CLSS06	←	←	Sets color system to PAL M.				●	
CLSS07	←	←	Sets color system to PAL N.				●	
SIGNAL FORMAT								
SFT	←	←	Displays the present set value of the SIGNAL FORMAT.					
SFTS01	←	←	Sets SIGNAL FORMAT to Type1.				●	Note 1
SFTS02	←	←	Sets SIGNAL FORMAT to Type2.				●	Note 1
SFTS03	←	←	Sets SIGNAL FORMAT to Type3.				●	Note 1
SFTS04	←	←	Sets SIGNAL FORMAT to Type4.				●	Note 1
–	SFTS05	←	Sets SIGNAL FORMAT to Type5.				●	
–	SFTS06	←	Sets SIGNAL FORMAT to Type6.				●	
–	SFTS07	←	Sets SIGNAL FORMAT to Type7.				●	
–	SFTS08	←	Sets SIGNAL FORMAT to Type8.				●	
–	←	SFTS09	Sets SIGNAL FORMAT to Type9.				●	New
–	←	SFTS20	Sets SIGNAL FORMAT to Type10.				●	New
–	SFTS10	←	Sets SIGNAL FORMAT to AUTO.				●	
DVI								
EDIS01	DSGS01	←	Sets the DVI connection signal to PC.				●	Note 2
EDIS02	DSGS02	←	Sets the DVI connection signal to STB/DVD.				●	Note 2
–	DBLS01	←	Sets the DVI BLACK LEVEL to LOW.				●	
–	DBLS02	←	Sets the DVI BLACK LEVEL to HIGH.				●	

Note 1: The operation differs between the PDP-434CMX/PDP-505CMX and PDP-425CMX/PDP-507CMX/PDP-427CMX

Note 2: EDIS01/02 only operates on the PDP-505CMX

■ “MENU”-“OPTION” related commands

Command 434CMX 505CMX	Command 425CMX	Command 427CMX 507CMX	Function	Number direct			Last memory	Comment
				Effective	Minimum	Maximum		
ENERGY SAVE								
ESV	←	←	Displays the present set value of ENERGY SAVE.					
ESVS00	←	←	Sets ENERGY SAVE to STANDARD (STANDARD1).				●	Sets STANDARD1 only on the 507CMX
ESVS01	←	←	Sets ENERGY SAVE to save energy.				●	
ESVS02	←	←	Sets ENERGY SAVE to fixed brightness.				●	
ESVS03	←	←	Sets ENERGY SAVE to mode 3 (long service life).				●	
ESVS04	←	←	Sets ENERGY SAVE to AUTO.				●	
–	←	ESVS05	Sets ENERGY SAVE to MUTE.				●	New
–	←	ESVS06	Sets ENERGY SAVE to standard 2.				●	New, and effective only on the 507CMX
TIMER								
–	TSMS00	←	Turns summer time to OFF.				●	
–	TSMS01	←	Turns summer time to ON.				●	
–	TPH	←	Sets the hour of the present time.	●	000	023	●	000 – 023: Set by 24-hour clock time
–	TPM	←	Sets the minute of the present time.	●	000	059	●	000 – 059: Set for 60 minutes
–	TPW	←	Sets the day of week of the present time.	●	001	007	●	001: Monday – 007; Saturday
–	TPTS00	←	Sets PROGRAM TIMER/REPEAT TIMER to OFF.				●	
–	TPTS01	←	Sets PROGRAM TIMER to ON.				●	
–	←	TPTS02	Sets REPEAT TIMER to ON.				●	New
ORBITER								
OMN	ORBS00	←	Sets the ORBITER to OFF.				●	
OMY	ORBS01	←	Sets the ORBITER to ON (AUTO1).				●	
–	ORBS02	←	Sets the ORBITER to ON (AUTO2).				●	
–	ORBS03	←	Sets the ORBITER to ON (AUTO3).				●	
SOFT FOCUS								
–	SOFS00	←	Sets SOFT FOCUS to OFF.				●	
–	SOFS01	←	Sets SOFT FOCUS to 1.				●	
–	SOFS02	←	Sets SOFT FOCUS to 2.				●	
–	SOFS03	←	Sets SOFT FOCUS to 3.				●	
–	SOFS04	←	Sets SOFT FOCUS to 4.				●	
SUB SCREEN FREEZE								
–	SSTS00	←	Sets SUB SCREEN FREEZE to OFF.				●	
–	SSTS01	←	Sets SUB SCREEN FREEZE to SIDE BY SIDE.				●	
–	SSTS02	←	Sets SUB SCREEN FREEZE to PinP.				●	

RS-232C Adjustment

■ “INTEGRATOR” – “PICTURE” related commands

Command 434CMX 505CMX	Command 425CMX	Command 427CMX 507CMX	Function	Number direct			Last memory	Comment
				Effective	Minimum	Maximum		
VIDEO QUALITY								
CNT	←	←	Adjusts the contrast.	●	000	255	●	
BRT	←	←	Adjusts the brightness.	●	000	255	●	
ENH	←	←	Adjusts the horizontal enhance.	●	000	015	●	
ENV	←	←	Adjusts the vertical enhance.	●	000	015	●	
COL	←	←	Adjusts the color.	●	000	127	●	
TNT	←	←	Adjusts the tint.	●	000	060	●	
SHP	←	←	Adjusts the sharpness.	●	000	015	●	
WHITE BALANCE								
RHI	←	←	Adjusts R.HIGH of the white balance.	●	000	255	●	
GHI	←	←	Adjusts G.HIGH of the white balance.	●	000	255	●	
BHI	←	←	Adjusts B.HIGH of the white balance.	●	000	255	●	
GLW	←	←	Adjusts G.LOW of the white balance.	●	000	255	●	
RLW	←	←	Adjusts R.LOW of the white balance.	●	000	255	●	
BLW	←	←	Adjusts B.LOW of the white balance.	●	000	255	●	
COLOR DETAIL								
CGR	←	←	Adjusts color detail red.	●	000	060	●	
CGY	←	←	Adjusts color detail yellow.	●	000	060	●	
CGG	←	←	Adjusts color detail green.	●	000	060	●	
CGC	←	←	Adjusts color detail cyan.	●	000	060	●	
CGB	←	←	Adjusts color detail blue.	●	000	060	●	
CGM	←	←	Adjusts color detail magenta.	●	000	060	●	
GAMMA								
GRA	←	←	Displays the present set value of gradation.					
–	GRAS18	←	Sets gradation GAMMA 1.8.				●	
–	GRAS19	←	Sets gradation GAMMA 1.9.				●	
–	GRAS20	←	Sets gradation GAMMA 2.0.				●	
–	GRAS21	←	Sets gradation GAMMA 2.1.				●	
–	GRAS22	←	Sets gradation GAMMA 2.2.				●	
–	GRAS23	←	Sets gradation GAMMA 2.3.				●	
–	GRAS24	←	Sets gradation GAMMA 2.4.				●	
PRESET								
STD	←	←	Restores the PICTURE, W/B adjustment value of the integrator to the initial values.				●	

■ “INTEGRATOR” – “SCREEN” related commands

Command 434CMX 505CMX	Command 425CMX	Command 427CMX 507CMX	Function	Number direct			Last memory	Comment
				Effective	Minimum	Maximum		
POSITION								
HPS	←	←	Adjusts the horizontal position.	●	000	255	●	
VPS	←	←	Adjusts the vertical position.	●	000	255	●	
CLOCK/PHASE								
CFR	←	←	Adjusts the CLOCK (PLL frequency).	●	000	255	●	
CPH	←	←	Adjusts the PHASE (PLL phase).	●	000	031	●	
SIZE								
HSI	←	←	Adjusts the horizontal size.	●	000	064	●	
VSI	←	←	Adjusts the vertical size.	●	000	064	●	
PRESET								
FRP	←	←	Restores the SCREEN adjustment value of the integrator to the initial values.				●	

■ “INTEGRATOR” – “SETUP” related commands

Command 434CMX 505CMX	Command 425CMX	Command 427CMX 507CMX	Function	Number direct			Last memory	Comment
				Effective	Minimum	Maximum		
SUB VOLUME								
SVL	←	←	Adjusts the SUB VOLUME.	●	000	020	●	

■ “INTEGRATOR”-“OPTION” related commands

Command 434CMX 505CMX	Command 425CMX	Command 427CMX 507CMX	Function	Number direct			Last memory	Comment
				Effective	Minimum	Maximum		
SCREEN MASK								
FMK	←	←	Displays the present set value of SCREEN MASK.					
FMKS00	←	←	Sets SCREEN MASK to OFF.				●	
FMKS02	←	←	Sets SCREEN MASK to inverse (negative – positive reversed).				●	
FMKS03	←	←	Sets SCREEN MASK to white mask.				●	
FMKS04	←	←	Sets SCREEN MASK to red mask.				●	
FMKS05	←	←	Sets SCREEN MASK to green mask.				●	
FMKS06	←	←	Sets SCREEN MASK to blue mask.				●	
FMKS07	←	←	Sets SCREEN MASK to yellow mask.				●	
SIDE MASK								
RSL	←	←	Adjusts side mask RED.	●	000	255	●	
GSL	←	←	Adjusts side mask GREEN.	●	000	255	●	
BSL	←	←	Adjusts side mask BLUE.	●	000	255	●	
–	←	SMAS00	Sets AUTO SIDE MASK to OFF.					New
–	←	SMAS01	Sets AUTO SIDE MASK to ON.					New
VIDEO WALL								
MGF	←	←	Displays the set value of VIDEO WALL.					
MGFS00	←	←	Sets VIDEO WALL to OFF.				●	
–	MGFS11	←	Sets VIDEO WALL to DIVIDER:1.				●	
–	MGFS12	←	Sets VIDEO WALL to DIVIDER:4.				●	
–	MGFS13	←	Sets VIDEO WALL to DIVIDER:9.				●	
–	MGFS14	←	Sets VIDEO WALL to DIVIDER:16.				●	
–	MGFS15	←	Sets VIDEO WALL to DIVIDER:25.				●	
MGP	←	←	Displays the present VIDEO WALL (accounting/not accounting for expanded position/joints) setting.					
MGPSnn	←	←	nn=01 to 04: Sets display position during DIVIDER=2 x 2 (not accounting for joints).				●	
			nn=05 to 08: Sets display position during DIVIDER=2 x 2 (accounting for joints).				●	
			nn=10 to 18: Sets display position during DIVIDER=3 x 3 (not accounting for joints).				●	
			nn=20 to 28: Sets display position during DIVIDER=3 x 3 (accounting for joints).				●	
			nn=30 to 3F: Sets display position during DIVIDER=4 x 4 (not accounting for joints).				●	
			nn=40 to 4F: Sets display position during DIVIDER=4 x 4 (accounting for joints).				●	
			nn=50 to 68: Sets display position during DIVIDER=5 x 5 (not accounting for joints).				●	
nn=70 to 88: Sets display position during DIVIDER=5 x 5 (accounting for joints).				●				
–	IDA	←	Executes AUTO ID setting.				●	
–	PDES00	←	Sets POWER ON DELAY mode to OFF.				●	
–	PDES01	←	Sets POWER ON DELAY mode to ON (other than cases used for a higher than 16 screen system) or mode 1 (used for a higher than 16 screen system).				●	
–	PDES02	←	Sets POWER ON DELAY mode 2 (used for a higher than 16 screen system).				●	
–	LNKS00	←	Sets ABL link to OFF.				●	
–	LNKS01	←	Sets ABL link to ON.				●	
RS-232C								
BRA	←	←	Displays the present set value of baud rate.					
BRAS01	←	←	Sets the RS-232C baud rate to 1200 bps.				●	
BRAS02	←	←	Sets the RS-232C baud rate to 2400 bps.				●	
BRAS03	←	←	Sets the RS-232C baud rate to 4800 bps.				●	
BRAS04	←	←	Sets the RS-232C baud rate to 9600 bps.				●	
BRAS05	←	←	Sets the RS-232C baud rate to 19200 bps.				●	
BRAS06	←	←	Sets the RS-232C baud rate to 38400 bps.				●	
ID NUMBER								
IDC	←	←	Clears the ID number.				●	
IDS	←	←	Sets the ID number.				●	

RS-232C Adjustment

Command 434CMX 505CMX	Command 425CMX	Command 427CMX 507CMX	Function	Number direct			Last memory	Comment
				Effective	Minimum	Maximum		
FAN								
FCM	←	←	Maximizes fan rotation control.				●	
FCA	←	←	Automates fan rotation control.				●	
–	–	FCU	Sets integrator's fan rotation control maximum to apply a brightness				●	New, and effective only on the 507CMX
OSD								
DIN	OSDS00	←	Sets OSD display to OFF.				●	
DIY	OSDS01	←	Sets OSD display to ON.				●	
–	OSSS01	←	Displays expanded OSD.				●	
–	OSSS02	←	Displays contracted OSD.				●	
–	OSAS01	←	Sets the OSD display angle to horizontal.				●	
–	OSAS02	←	Sets the OSD display angle to vertical.				●	
FRONT INDICATOR								
LEN	LESS00	←	Sets the FRONT INDICATOR to OFF.				●	
LEY	LESS01	←	Sets the FRONT INDICATOR to ON.				●	
COLOR MODE								
CM1	CLMS00	←	Sets the COLOR MODE to NORMAL.				●	
CM2	CLMS01	←	Sets the COLOR MODE to STUDIO.				●	
UNDER SCAN								
USCS00	←	←	Sets the UNDERSCAN setting to OFF.				●	
USCS01	←	←	Sets the UNDERSCAN setting to ON.				●	
USC	←	←	Displays the present set value of UNDERSCAN.					
IMAGE PROCESS								
–	IPR	←	Obtains the present IMAGE PROCESS setting.					
–	IPRS01	←	Sets the IMAGE PROCESS to NORMAL.				●	
–	IPRS02	←	Sets the IMAGE PROCESS to PURE.				●	
–	IPRS03	←	Sets the IMAGE PROCESS to MONOTONE.				●	
–	IPRS04	←	Sets the IMAGE PROCESS to HIGH CONTRAST.				●	
–	–	IPRS05	Sets the IMAGE PROCESS to BLUE ONLY.				●	New
FRC								
FRC	←	←	Displays the present set value of FRC.					
–	FRCS00	←	Sets the FRC to OFF.				●	
FRCS01	←	←	Sets the FRC to ON.				●	Note 1
SEAMLESS INPUT SWITCH								
–	SLSS00	←	Sets the SEAMLESS INPUT SWITCH mode to OFF.				●	
–	SLSS01	←	Sets the SEAMLESS INPUT SWITCH mode to ON.				●	
–	SL1S01	←	Sets the SEAMLESS SW SELECT 1 to INPUT1.				●	
–	SL1S02	←	Sets the SEAMLESS SW SELECT 1 to INPUT2.				●	
–	SL1S03	←	Sets the SEAMLESS SW SELECT 1 to INPUT3.				●	
–	SL1S04	←	Sets the SEAMLESS SW SELECT 1 to INPUT4.				●	
–	SL1S05	←	Sets the SEAMLESS SW SELECT 1 to INPUT5.				●	
–	SL2S01	←	Sets the SEAMLESS SW SELECT 2 to INPUT1.				●	
–	SL2S02	←	Sets the SEAMLESS SW SELECT 2 to INPUT2.				●	
–	SL2S03	←	Sets the SEAMLESS SW SELECT 2 to INPUT3.				●	
–	SL2S04	←	Sets the SEAMLESS SW SELECT 2 to INPUT4.				●	
–	SL2S05	←	Sets the SEAMLESS SW SELECT 2 to INPUT5.				●	
MIRROR								
MIRS00	←	←	Sets mirror mode to OFF (normal display).				●	
MIRS01	←	←	Performs left-right reversal with MIRROR MODE.				●	
MIRS02	←	←	Performs up-down reversal with MIRROR MODE.				●	
MIRS03	←	←	Performs up-down left-right reversal with MIRROR MODE.				●	
MULTI SCREEN								
–	PTRS00	←	Sets sub screen translucence to OFF (0%).				●	
–	PTRS01	←	Sets sub screen translucence to 10 %.				●	
–	PTRS02	←	Sets sub screen translucence to 20 %.				●	
–	PTRS03	←	Sets sub screen translucence to 30 %.				●	
–	PTRS04	←	Sets sub screen translucence to 40 %.				●	
–	PTRS05	←	Sets sub screen translucence to 50 %.				●	
–	PTRS06	←	Sets sub screen translucence to 60 %.				●	
–	PTRS07	←	Sets sub screen translucence to 70 %.				●	
–	PTRS08	←	Sets sub screen translucence to 80 %.				●	

Note 1: The operation differs between the PDP-434CMX/PDP-505CMX and PDP-425CMX/PDP-507CMX/PDP-427CMX

RS-232C Adjustment

Command 434CMX 505CMX	Command 425CMX	Command 427CMX 507CMX	Function	Number direct			Last memory	Comment
				Effective	Minimum	Maximum		
–	BPIS01	←	Sets the BANNER PinP input to INPUT1.				●	
–	BPIS02	←	Sets the BANNER PinP input to INPUT2.				●	
–	BPPS00	←	Sets the BANNER PinP setting to OFF.				●	
–	BPPS01	←	Sets the BANNER PinP setting to TOP3.				●	
–	BPPS02	←	Sets the BANNER PinP setting to MID-HIGH.				●	
–	BPPS03	←	Sets the BANNER PinP setting to MID-LOW.				●	
–	BPPS04	←	Sets the BANNER PinP setting to BOTTOM3.				●	
–	←	BPPS05	Sets the BANNER PinP setting to TOP2.				●	New
–	←	BPPS06	Sets the BANNER PinP setting to BOTTOM2.				●	New
–	←	BPPS07	Sets the BANNER PinP setting to TOP1.				●	New
–	←	BPPS08	Sets the BANNER PinP setting to BOTTOM1.				●	New
–	←	BPPS09	Sets the BANNER PinP setting to LEFT.				●	New
–	←	BPPS10	Sets the BANNER PinP setting to RIGHT.				●	New
–	←	PFAS00	PIP fade in function ineffective.				●	New
–	←	PFAS01	PIP fade in function effective.				●	New
–	←	PFAS10	PIP fade in (only when PIP fade in function is effective).				●	New
–	←	PFAS11	PIP fade off (only when PIP fade in function is effective).				●	New
FUNCTION								
FDT	←	←	Executes FUNCTION DEFAULT.				●	

■ Other commands

Command 434CMX 505CMX	Command 425CMX	Command 427CMX 507CMX	Function	Number direct			Last memory	Comment
				Effective	Minimum	Maximum		
DISPLAY CALL								
–	DITS01	←	Displays DISPLAY CALL 1.					
–	DITS02	←	Displays DISPLAY CALL 2.					
–	IM0	←	INFORMATION write-in (1-3 characters).				●	
–	IM1	←	INFORMATION write-in (4-6 characters).				●	
–	IM2	←	INFORMATION write-in (7-9 characters).				●	
–	IM3	←	INFORMATION write-in (10-12 characters).				●	
–	IM4	←	INFORMATION write-in (13-15 characters).				●	
–	IM5	←	INFORMATION write-in (16-18 characters).				●	
–	IM6	←	INFORMATION write-in (19-21 characters).				●	
–	IMD	←	Clears INFORMATION.				●	
AUXILIARY COMMAND								
DW0	←	←	Subtracts 10 from the adjustment value.					
DWF	←	←	Minimizes the adjustment value.					
DWn	←	←	Subtracts n from the adjustment value. (n=1-9)					
UP0	←	←	Adds 10 to the adjustment value.					
UPF	←	←	Maximizes the adjustment value.					
UPn	←	←	Adds n to the adjustment value (n = 1 to 9).					
GST	QST	←	Obtains status information.					
GPI	QPI	←	Obtains integrator/PICTURE information.					
GWB	QWB	←	Obtains integrator/WHITE BALANCE information.					
GPS	QPS	←	Obtains integrator/SCREEN information.					
GSS	QSS	←	Obtains SETUP information.					
GSO	QSO	←	Obtains Menu Integrator/OPTION information.					
–	QAP	←	Obtains various machine names.					
–	QCI	←	Obtains time information.					
–	QSU	←	Obtains audio status.					
OTHER								
–	–	MRKS00	Sets mark display off.					New
–	–	MRKS01	Sets mark display on.					New
–	–	RMCS10	Remote control key: CURSOR RIGHT					New
–	–	RMCS11	Remote control key: CURSOR LEFT					New
–	–	RMCS12	Remote control key: CURSOR UP					New
–	–	RMCS13	Remote control key: CURSOR DOWN					New
–	–	RMCS14	Remote control key: SET					New
–	–	RMCS25	Remote control key: MENU					New

RS-232C Adjustment

Command 434CMX 505CMX	Command 425CMX	Command 427CMX 507CMX	Function	Number direct			Last memory	Comment
				Effective	Minimum	Maximum		
–	–	RMCS26	Remote control key: POINT ZOOM					New
–	–	RMCS27	Remote control key: ID NO SET					New
–	–	RMCS28	Remote control key: CLEAR					New
–	–	RMCS29	Remote control key: FREEZE					New
–	–	RMCS30	Remote control key: STANDBY/ON					New
–	–	RMCS31	Remote control key: VOLUME UP					New
–	–	RMCS32	Remote control key: VOLUME DOWN					New
–	–	RMCS33	Remote control key: MUTING					New
–	–	RMCS34	Remote control key: SCREEN SIZE					New
–	–	RMCS35	Remote control key: SPLIT					New
–	–	RMCS36	Remote control key: SUB INPUT					New
–	–	RMCS37	Remote control key: PIP SHIFT					New

6 QUEST Commands

What are QUEST commands?

- Quest commands output TXD such as adjustment data from the panel's microprocessor to a PC.
- Adjustment and other data is output in ASCII code.

Note Command names are given inside brackets < >.

- Data output format

STX (02hex)	Command (3 Byte)	Data	Data	Checksum (2 Byte)	ETX (03hex)
-------------	------------------	------	------	------	-------------------	-------------

Note

- A QUEST command is invalid when no ID has not been assigned.
- A QUEST command is invalid when a wildcard (*) is used in the ID when sending the command.

■ Quest Command Table

Command 434CMX 505CMX	Command 425CMX	Command 427CMX 507CMX	Function	Number direct			Last memory	Comment
				Effective	Minimum	Maximum		
GST	QST	←	Obtains status information.					
GPI	QPI	←	Obtains integrator/PICTURE information.					
GWB	QWB	←	Obtains integrator/WHITE BALANCE information.					
GPS	QPS	←	Obtains integrator/SCREEN information.					
GSS	QSS	←	Obtains SETUP information.					
GSO	QSO	←	Obtains Menu Integrator/OPTION information.					
-	QAP	←	Obtains audio status.					
-	QCI	←	Obtains time information.					
-	QSU	←	Obtains various machine names.					

RS-232C Adjustment

1) Obtaining QST Status Information

Sequence	Data Content	Size	Remarks
1	STX	1 Byte	02hex
2	Command echo-back	3 Byte	QST (fixed)
3	Generation information	1 Byte	5 (fixed)
4	Inch information	1 Byte	4: 42 inch 5: 50 inch
5	Forwarding	1 Byte	M (fixed)
6	Power source state	1 Byte	S: Standby status P: Power supplied status
7	During standby: Standby cause	1 Byte	N: Normal standby time W: Standby time based on POWER MANAGEMENT S: Standby time based on SD or PD
	During power supply: main screen signal status		N: normal signal input time L: no signal input time O: OUT OF RANGE signal input time
8	During standby or 1 screen display: dummy data	1 Byte	N: normal signal input time L: no signal input time O: OUT OF RANGE signal input time
	During 2-screen display: sub screen signal status		
9	Main input function information	3 Byte	IN1: INPUT1 IN2: INPUT2 IN3: INPUT3 IN4: INPUT4 IN5: INPUT5
10	Sub input function information	3 Byte	IN1: INPUT1 IN2: INPUT2 IN3: INPUT3 IN4: INPUT4 IN5: INPUT5 Note1)
11	Main screen size information	1 Byte	0: DOT BY DOT 1: 4:3 2: FULL 3: ZOOM 5: WIDE 6: 14:9 9: UNDERSCAN A: 2.35:1
12	Two-screen display state	1 Byte	0: OFF (1 screen) 1: SIDE BY SIDE 1 2: PinP (lower right) 3: PinP(upper right) 4: PinP (upper left) 5: PinP(lower left) 6: SIDE BY SIDE 2-L 9: SIDE BY SIDE 2-R A: SIDE BY SIDE 3 B: SIDE BY SIDE 4-L C:SIDE BY SIDE 4-R
13	Functional lock information	1 Byte	0: LOCK OFF 1: BUTTONS LOCK 2: IR LOCK 2: IR LOCK 3: IR&BUTTONS LOCK 4: MEMORY LOCK
14	Temperature information 1 (interior)	3 Byte	Temperature inside the set (Centigrade) Note 2)
15	Temperature information 2 (outside air)	3 Byte	Outside air temperature (Celsius) Note 2)
16	Temperature information 3 (SLOT)	3 Byte	SLOT temperature (Celsius) Note 2)
17	Serial No.	15 Byte	15 digit character string
18	Dummy data	3 Byte	
19	Dummy data	2 Byte	
20	HOUR METER	5 Byte	5 digit number
21	Check sum	2 Byte	
22	ETX	1 Byte	03hex

Note 1) During standby and during a single screen display, the unit outputs the value that is in memory.

Note 2) During standby and immediately after POWER ON, the correct value is not output.

In this case, please obtain the information after waiting a short period of time after POWER ON.

These types of information are output as reference information (these are not guaranteed information).

Normally refer to temperature information 3.

2) <QPI> Obtaining Integrator/PICTURE information

Sequence	Data Content	Size	Remarks
1	STX	1 Byte	02hex
2	Command echo-back	3 Byte	QPI (fixed)
3	CONTRAST	3 Byte	000 to 255 Note 1)
4	BRIGHTNESS	3 Byte	000 to 255 Note 1)
5	C,DETAIL R (RED)	3 Byte	000 to 060 Note 1)
6	C,DETAIL Y (YELLOW)	3 Byte	000 to 060 Note 1)
7	C,DETAIL G (GREEN)	3 Byte	000 to 060 Note 1)
8	C,DETAIL C (CYAN)	3 Byte	000 to 060 Note 1)
9	C,DETAIL B (BLUE)	3 Byte	000 to 060 Note 1)
10	C,DETAIL M (MAGENTA)	3 Byte	000 to 060 Note 1)
11	H.ENHANCE	3 Byte	000 to 015 Note 1), Note 2)
12	V.ENHANCE	3 Byte	000 to 015 Note 1), Note 2)
13	COLOR	3 Byte	000 to 127 Note 1), Note 3)
14	TINT	3 Byte	000 to 060 Note 1), Note 3)
15	SHARPNESS	3 Byte	000 to 015 Note 1), Note 3)
16	Main input function	3 Byte	Same as item 9 of QST commands
17	Main screen size information	1 Byte	Same as item 11 of QST commands
18	Check sum	2 Byte	
19	ETX	1 Byte	03hex

Note 1) If the signal type is not confirmed, dummy data is output.

Note 2) During video signal input, dummy data is output.

Note 3) During PC signal input, dummy data is output.

3) <QWB> Obtaining integrator/WHITE BALANCE information

Sequence	Data Content	Size	Remarks
1	STX	1 Byte	02hex
2	Command echo-back	3 Byte	QWB (fixed)
3	R.HIGH	3 Byte	000 to 255 Note 1)
4	G.HIGH	3 Byte	000 to 255 Note 1)
5	B.HIGH	3 Byte	000 to 255 Note 1)
6	R.LOW	3 Byte	000 to 255 Note 1)
7	G.LOW	3 Byte	000 to 255 Note 1)
8	B.LOW	3 Byte	000 to 255 Note 1)
9	Main input function	3 Byte	Same as item 9 of QST commands
10	Main screen size	1 Byte	Same as item 11 of QST commands
11	Check sum	2 Byte	
12	ETX	1 Byte	03hex

Note 1) If the signal type is not confirmed, dummy data is output.

4) <QPS> Obtaining integrator/SCREEN information

Sequence	Data Content	Size	Remarks
1	STX	1 Byte	02hex
2	Command echo-back	3 Byte	QPS (fixed)
3	H.POSITION	3 Byte	000 to 255 Note 1)
4	V.POSITION	3 Byte	000 to 255 Note 1)
5	H.SIZE	3 Byte	000 to 064 Note 1)
6	V.SIZE	3 Byte	000 to 064 Note 1)
7	CLOCK	3 Byte	000 to 255 Note 1), Note 2)
8	PHASE	3 Byte	000 to 031 Note 1), Note 2)
9	Main input function	3 Byte	Same as item 9 of QST commands
10	Main screen size information	1 Byte	Same as item 11 of QST commands
18	Check sum	2 Byte	
19	ETX	1 Byte	03hex

Note 1) If the signal type is not confirmed, dummy data is output.

Note 2) During DVI or video input, dummy data is output.

RS-232C Adjustment

5) <QSS> Obtaining SETUP information

Sequence	Data Content	Size	Remarks
1	STX	1 Byte	02hex
2	Command echo-back	3 Byte	QSS (fixed)
3	COLOR TEMP.	1 Byte	1: LOW 2: MID LOW 3: MIDDLE 4: MID HIGH 5: HIGH Note 1)
4	POWER MGT.	1 Byte	0: OFF 1: ON
5	AUTO POWER OFF	1 Byte	0: DISABLE 1: ENABLE
6	DNR	1 Byte	0: OFF 1: LOW 2: MIDDLE 3: HIGH Note 1)
7	MPEG NR	1 Byte	0: OFF 1: LOW 2: MIDDLE 3: HIGH Note 1)
8	CTI	1 Byte	0: OFF 1: ON Note 1)
9	PURECINEMA	1 Byte	0: OFF 1: ON Note 1)
10	COLOR DECODING	1 Byte	1: RGB 2: COMP1 3: COMP2 Note 1)
11	COLOR SYSTEM	1 Byte	1: AUTO 2: NTSC 3: PAL 4: SECAM 5: 4.43NTSC 6: PAL M 7: PAL N Note 1)
12	DVI SET UP (PLUG/PLAY)	1 Byte	1: PC 2: VIDEO Note 1)
13	DVI SET UP (BLACK LEVEL)	1 Byte	1: LOW 2: HIGH Note 1)
14	BRT.ENHANCE	1 Byte	0: OFF 1: ON Note 1)
15	SUB VOLUME	2 Byte	00 to 20
16	Main input function	3 Byte	Same as item 9 of QST commands
17	Main screen size information	1 Byte	Same as item 11 of QST commands
18	Check sum	2 Byte	
19	ETX	1 Byte	03hex

Note 1) In the case of set data that cannot be output because of the type of input signal, dummy data is output.

6) <QSO> Obtaining menu integrator/OPTION information

Sequence	Data Content	Size	Remarks
1	STX	1 Byte	02hex
2	Command echo-back	3 Byte	QSO (fixed)
3	ENERGY SAVE	1 Byte	0: STANDARD1 1: MODE1 2: MODE2 3: MODE3 4: AUTO 5: MUTE 6: STANDARD2
4	PROGRAM/REPEAT timer	1 Byte	0: OFF 1: PROGRAM 2: REPEAT
5	SCREEN MANAGEMENT (ORBITER)	1 Byte	0: OFF 1: MODE1 2: MODE2 3: MODE3
6	SCREEN MANAGEMENT (SOFT FOCUS)	1 Byte	0: OFF 1: 1 2: 2 3: 3 4: 4
7	AUTO SETUP MODE	1 Byte	0: INACTIVE 1: ACTIVE
8	AUTO FUNCTION	1 Byte	0: OFF 1: INPUT1 2: INPUT4
9	PIP DETECT	1 Byte	0: INACTIVE 1: ACTIVE
10	SPLIT FREEZE	1 Byte	0: OFF 1: SIDE BY SIDE 2: PIP
11	SCREEN MASK	1 Byte	0: OFF 2: INVERSE 3: WHITE 4: RED 5: GREEN 6: BLUE 7: YELLOW
12	SIDE MASK R-LEVEL	3 Byte	000 to 255
13	SIDE MASK G-LEVEL	3 Byte	000 to 255
14	SIDE MASK B-LEVEL	3 Byte	000 to 255
15	VIDEO WALL (MODE)	1 Byte	0: OFF 1: 1 screen 2: 4 screens (2 x 2) 3: 9 screens (3 x 3) 4: 16 screens (4 x 4) 5: 25 screens (5 x 5)
16	VIDEO WALL (POSITION)	2 Byte	01 to 56
17	VIDEO WALL (TYPE)	1 Byte	0: NORMAL 1: ADJUSTED
18	VIDEO WALL (POWER ON DELAY)	1 Byte	0: OFF 1: ON 2: MODE1 3: MODE2
19	VIDEO WALL (ABL LINK)	1 Byte	0: OFF 1: ON
20	Spare (dummy)	1 Byte	*(FIX)
21	FAN CONTROL	1 Byte	1: AUTO 2: MAX
22	OSD DISPLAY	1 Byte	0: OFF 1: ON
23	OSD SIZE	1 Byte	0: LARGE 1: SMALL
24	OSD ANGLE	1 Byte	0: H 1: V
25	FRONT INDICATOR	1 Byte	0: OFF 1: ON
26	COLOR MODE	1 Byte	1: NORMAL 2: STUDIO

Sequence	Data Content	Size	Remarks
27	PRO USE UNDERSCAN	1 Byte	0: OFF 1: ON
28	PRO USE IMAGE PROCESS	1 Byte	1: NORMAL 2: PURE 3: MONOTONE 4: BLUE ONLY 5: HIGH CONTRAST
29	PRO USE SYGNAI TYPE	1 Byte	1: MOTION 2: STILL 3: NONE STD
30	FRC	1 Byte	0: OFF 1: ON
31	POWER ON MODE INPUT	1 Byte	See the table below.
32	POWER ON MODE MULTI MODE	1 Byte	See the table below.
33	POWER ON MODE MULTI INPUT 1	1 Byte	1: INPUT 2: INPUT2 3: INPUT3 4: INPUT4 5: INPUT5
34	POWER ON MODE MULTI INPUT 2	1 Byte	1: INPUT 2: INPUT2 3: INPUT3 4: INPUT4 5: INPUT5
35	POWER ON MODE VOLUME	2 Byte	0 to 42: In the case of last memory, FF
36	SEAMLESS SW	1 Byte	0: OFF 1: ON
37	SEAMLESS SW SELECT1		1: INPUT 2: INPUT2 3: INPUT3 4: INPUT4 5: INPUT5
38	SEAMLESS SW SELECT2	1 Byte	1: INPUT 2: INPUT2 3: INPUT3 4: INPUT4 5: INPUT5
39	MIRROR MODE	1 Byte	0: OFF 1: X 2: Y 3: XY
40	MULTI SCREEN SET (S BY S SIZE)	1 Byte	1: NORMAL 2: FULL
41	MULTI SCREEN SET (S BY S LAYOUT)	1 Byte	1: MODE1 2: MODE2 3: MODE3
42	MULTI SCREEN SET (PIP SIZE)	1 Byte	1: 1 (SMALL) to 4: 4 (LARGE)
43	MULTI SCREEN SET (TRANSLUCENT)	1 Byte	0: OFF 1: 10 % 2: 20 % 3: 30 % 4: 40 % 5: 50 % 6: 60 % 7: 70 % 8: 80 %
44	MULTI SCREEN SET (BANNER PIP)	1 Byte	0: OFF 1: BOTTOM1 2: BOTTOM2 3: BOTTOM3 4: MID LOW 5: MID HIGH 6: TOP3 7: TOP2 8: TOP1 9: LEFT A: RIGHT
45	MULTI SCREEN SET (BANNER INPUT)	1 Byte	1: INPUT1 2: INPUT2
46	Main input function	3 Byte	Input functions of the main screen (refer to the following table for details)
47	Main screen size information	1 Byte	Main screen size (refer to the following table for details)
48	Check sum	2 Byte	
49	ETX	1 Byte	03hex

■ POWER ON MODE INPUT

Input functions (response)	INPUT
0	LAST
1	INPUT1
2	INPUT2
3	INPUT3
4	INPUT4
5	INPUT5
A	MULTI

■ POWER ON MODE MULTI MODE

Input functions (response)	INPUT
1	SIDE BY SIDE1
2	SIDE BY SIDE2
3	SIDE BY SIDE3
4	BOTTOM LEFT
5	BOTTOM RIGHT
6	TOP RIGHT
7	TOP LEFT

■ Main screen input function

Input function	Input
IN1	INPUT1
IN2	INPUT2
IN3	INPUT3
IN4	INPUT4
IN5	INPUT5
***	Unconfirmed (standby time)

■ Main screen size

Main screen size	Screen size
0	DOT BY DOT
1	4 : 3
2	FULL
3	ZOOM
5	WIDE
6	14 : 9
9	UNDER SCAN
A	2.35 : 1

RS-232C Adjustment

7) <QSU> obtaining the audio status

Sequence	Data Content	Size	Remarks
1	STX	1 Byte	02hex
2	Command echo-back	3 Byte	QSU (fixed)
3	Main volume	3 Byte	000 to 042
4	Audio mute status	1 Byte	0: OFF 1: ON
5	INPUT1 sub volume	3 Byte	000 to 020
6	INPUT2 sub volume	3 Byte	000 to 020
7	INPUT3 sub volume	3 Byte	000 to 020
8	INPUT4 sub volume	3 Byte	000 to 020
9	INPUT5 sub volume	3 Byte	000 to 020
10	Check sum	2 Byte	
11	ETX	1 Byte	03hex

8) <QCI> Obtaining time information

Sequence	Data Content	Size	Remarks
1	STX	1 Byte	02hex
2	Command echo-back	3 Byte	QCI (fixed)
3	Time information	2 Byte	Hour (24 hour system) 00 to 23 Note 1)
		2 Byte	Minute 00 to 59 Note 1)
		2 Byte	Second 00 to 59 Note 1)
4	Dummy data	8 Byte	
5	Day of week	1 Byte	1: Sunday 2: Monday 3: Tuesday 4: Wednesday 5: Thursday 6: Friday 7: Saturday Note 1)
6	Check sum	2 Byte	
7	ETX	1 Byte	03hex

Note 1) During standby and when this command was initially set, the value at the time that power was finally shut off is transmitted.

9) <QAP> Obtaining machine name

Sequence	Data Content	Size	Remarks
1	STX	1 Byte	02hex
2	Command echo-back	3 Byte	QAP (fixed)
3	Machine name information	18 Byte	42 inch: A (North America model): PDP-427CMX***** G (Europe-general model): PDP-42MXE20*****
			50 inch: J (Japan model): PDP-507CMX-JP***** A (North America model): PDP-507CMX***** G (Europe-general/CKD model): PDP-50MXE20***** GS (Europe-general/silver model): PDP-50MXE20*****
4	Check sum	2 Byte	
5	ETX	1 Byte	03hex

■ **Table of commands not compatible with PDP-434CMX to PDP-425CMX**

AJN	Ends 232C integrator adjustment mode.	MCN	Turns off MASK CONTROL.
AJY	Starts 232C integrator adjustment mode.	MCY	Turns on MASK CONTROL.
COF	Displays present color off setting.	MGFS01	Turns on VIDEO WALL.
COFS00	Does not set color off.	MSCS01	Turns on MULTI SCREEN.
COFS01	Sets color off.	SIM	Displays present setting of SIDE MASK.
DPR	Resets still picture movement function.	SIMS01	Sets setting of SIDE MASK to normal.
FXO	Selects audio output fix.	SIMS02	Sets setting of SIDE MASK to overlay 1.
FRCS02	Sets FRC to MODE2.	SIMS03	Sets setting of SIDE MASK to overlay 2.
FRCS03	Sets FRC to MODE3.	SZMS04	Sets screen size to CINEMA.
GRAS04	Sets gradation to "DRE MID".	SZMS08	Sets screen size to FULL 1035i.
GRAS05	Sets gradation to "DRE HIGH".	MIR	Displays present MIRROR MODE setting
GRAS06	Sets gradation to "DRE LOW".	PLN	Turns off center brightness correction.
GRAS07	Sets gradation to "HIGH CONTRAST".	PLY	Turns on center brightness correction.
LNN	Prohibits loudness.	PUCS02	Sets PURE CINEMA to advance.
LNK	Permits loudness	VRO	Selects audio output variable.

■ **Table of commands not compatible with PDP-505CMX**

EDIS01	Sets DVI SELECT to PC.
EDIS02	Sets DVI SELECT to VIDEOS1.

RS-232C Adjustment

■ Check Sum

This is data to which 2-Byte ASCII code is added to a data group returned by a QUEST command.

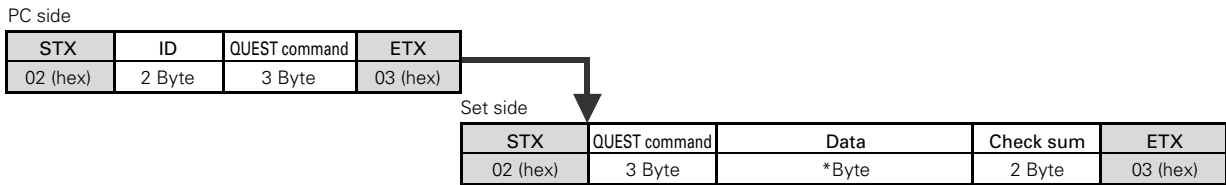

A detailed example is given below.

Example) The check sum value that is added when the QUEST command "QAA" returned the following 6-Byte data string.

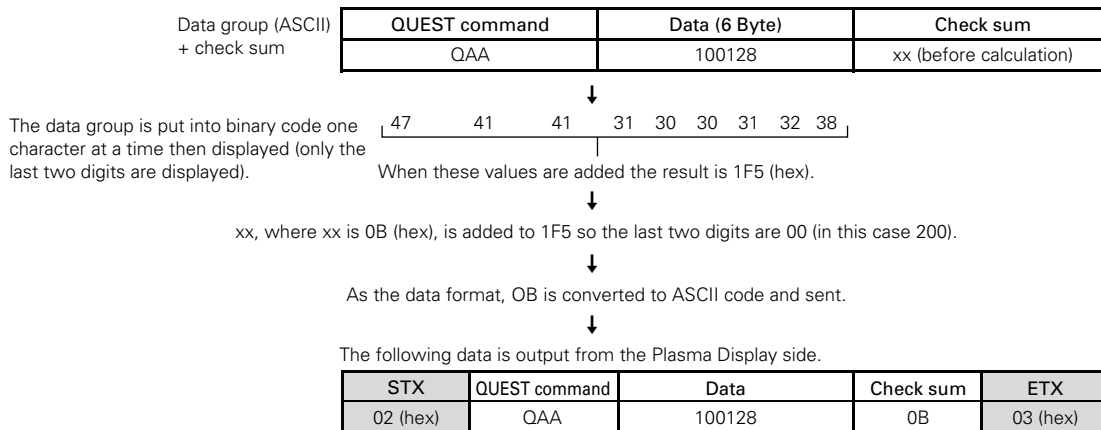

*** The returned data group is in capital letters. Please keep this in mind when introducing it into the binary display.**

■ Examples of check sum applications

Example 1) When the data is missing 1 Byte

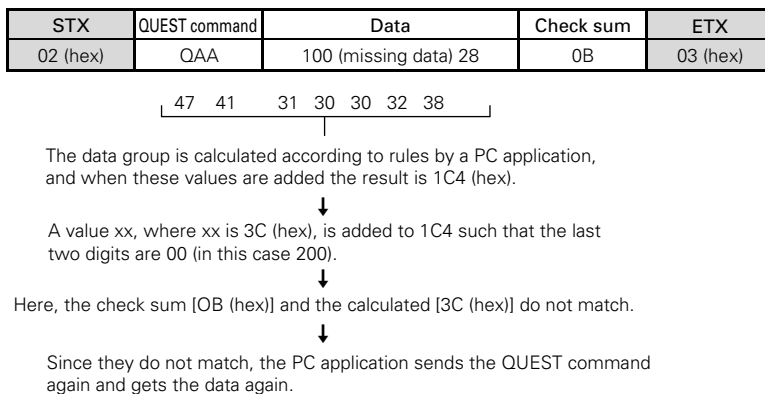

Example 2) When 1 Byte of data in the data is unreadable

